

**Appendix G1. Geotechnical Investigation for Fanita Commons,
Orchard Village, and Vineyard Village**

This page intentionally left blank.

GEOTECHNICAL INVESTIGATION

FANITA RANCH FANITA COMMONS, ORCHARD VILLAGE AND VINEYARD VILLAGE SANTEE, CALIFORNIA



GEOCON
INCORPORATED

GEOTECHNICAL
ENVIRONMENTAL
MATERIALS

PREPARED FOR

**HOMEFED CORPORATION
CARLSBAD, CALIFORNIA**

**APRIL 17, 2020
PROJECT NO. 05254-32-18A**



Project No. 05254-32-18A
April 17, 2020

HomeFed Corporation
1903 Wright Place, Suite 220
Carlsbad, California 92008

Attention: Mr. Tom Blessent

Subject: GEOTECHNICAL INVESTIGATION
FANITA RANCH
FANITA COMMONS, ORCHARD VILLAGE AND VINEYARD VILLAGE
SANTEE, CALIFORNIA

Dear Mr. Blessent:

In accordance with your request, we have prepared this geotechnical investigation report for the proposed development of Fanita Commons, Orchard Village and Vineyard Village in the Fanita Ranch property in Santee, California. The accompanying report presents the findings of our studies and our recommendations relative to the geotechnical aspects of developing the subject villages as presently proposed.

A majority of the information contained herein was presented in several reports from 1997 to 2007 during submittal of a previous *Tentative Map* and Specific Plan for the property. This report is a compilation of those previous studies and considers the new *Vesting Tentative Map* and Specific Plan.

Should you have any questions regarding this report, or if we may be of further service, please contact the undersigned at your convenience.

Very truly yours,

GEOCON INCORPORATED

Trevor E. Myers
RCE 63773

DBE:TEM:arm

(6/del) Addressee



David B. Evans
CEG 1860

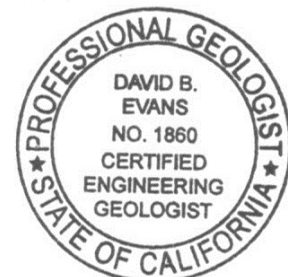

TABLE OF CONTENTS

1.	PURPOSE AND SCOPE	1
2.	SITE AND PROJECT DESCRIPTION.....	2
2.1	Fanita Commons.....	3
2.2	Orchard Village	3
2.3	Vineyard Village	4
2.4	Special Use Area	5
3.	PREVIOUS GEOTECHNICAL STUDIES.....	6
4.	SOIL AND GEOLOGIC CONDITIONS	6
4.1	Undocumented Fill (Qudf)	6
4.2	Topsoil (Unmapped).....	6
4.3	Alluvium (Qal)	7
4.4	Colluvium (Qcol).....	7
4.5	Alluvium/Debris Flow Deposits (Qal/Qdf)	7
4.6	Landslide Deposits (Qls)	7
4.7	Terrace Deposits (Qt)	9
4.8	Stadium Conglomerate (Tst)	9
4.9	Friars Formation (Tf).....	10
4.10	Granitic Rock (Kgr/Kgb).....	10
5.	GROUNDWATER/SEEPAGE.....	12
6.	GEOLOGIC STRUCTURE.....	12
7.	GEOLOGIC HAZARDS	13
7.1	Ancient Landslides	13
7.2	Debris Flow Deposits	13
7.3	Faulting and Seismicity	13
7.4	Seismicity-Deterministic Analysis	14
7.5	Seismicity-Probabilistic Analysis.....	14
7.6	Liquefaction.....	15
8.	CONCLUSIONS AND RECOMMENDATIONS	16
8.1	General	16
8.2	Soil and Excavation Characteristics	16
8.3	Terrace Drains	17
8.4	Grading.....	18
8.5	Slope Stability	19
8.6	Seismic Design Criteria.....	20
8.7	Foundation and Concrete Slab-On-Grade Recommendations.....	21
8.8	Retaining Walls and Lateral Loads Recommendations.....	26
8.9	Slope Maintenance	29
8.10	Site Drainage and Moisture Protection.....	29
8.11	Grading Plan Review.....	30

LIMITATIONS AND UNIFORMITY OF CONDITIONS

TABLE OF CONTENTS (Concluded)

MAPS AND ILLUSTRATIONS

- Figure 1, Vicinity Map
- Figures 2 – 3, Geologic Map (Map Pocket)
- Figures 4 – 7, Geologic Cross Sections
- Figure 8, Typical Canyon Subdrain Detail
- Figure 9, Typical Stability Fill Detail
- Figure 10, Surficial Slope Stability Analysis
- Figure 11, Slope Stability Analysis – Fill Slopes
- Figure 12, Slope Stability Analysis – Cut Slopes
- Figure 13, Wall/Column Footing Dimension Detail
- Figure 14, Typical Retaining Wall Drain Detail

APPENDIX A

BORING, TRENCH AND SEISMIC LOGS (1997)

APPENDIX B

AIR-TRACK BORING LOGS (2005)

APPENDIX C

BORING, TRENCH, AND AIR-TRACK BORING LOGS (2007)

APPENDIX D

SEISMIC REFRACTION SURVEY (2007)

APPENDIX E

LOGS OF TRENCHES (2014)

APPENDIX F

LABORATORY TESTING (1997)

APPENDIX G

LABORATORY TESTING (2007)

APPENDIX H

RECOMMENDED GRADING SPECIFICATIONS

LIST OF REFERENCES

GEOTECHNICAL INVESTIGATION

1. PURPOSE AND SCOPE

This report consolidates information from several geotechnical studies performed by Geocon Incorporated in the subject portion of Fanita Ranch since 1995 (reported in 1997). The previous studies supported a previous *Tentative Map* and Specific Plan which has been substantially modified as part of the new Fanita Ranch Specific Plan. Some of the modifications will require future additional field work, engineering analysis and an update geotechnical report as project plans progress. In our opinion, the information contained herein is sufficient for the current *Vesting Tentative Map/Preliminary Grading Plan* submittal to evaluate the site soil and geologic conditions as they relate to the proposed development and geotechnical constraints.

The subject villages are located in the northern half of the overall Fanita Ranch property in the City of Santee, California (see *Vicinity Map*, Figure 1). The purpose of the previous geotechnical studies was to investigate the soil and geologic conditions at the site as well as the geotechnical constraints that may impact areas of proposed development. Aerial photographs, readily available published and unpublished geologic literature, and previous geotechnical reports pertaining to the site were reviewed (see *List of References*). Please note, for continuity, the List of References is considered a “master list” applicable to all of our Fanita Ranch investigation reports. The scope also included performing several field investigations, laboratory testing to identify physical soil properties, engineering analyses and preparation of this report.

The geotechnical investigations for the subject villages were performed in conjunction with our overall study of Fanita Ranch, Fanita Parkway, off-site Cuyamaca Street, and off-site Magnolia Avenue. Field operations for the studies were conducted intermittently between February 6, 1995 and July 17, 2014 and consisted of a site reconnaissance by an engineering geologist, drilling 85 large-diameter borings and 62 air-track borings, performing 21 seismic refraction traverses, and excavating 207 exploratory trenches. The emphasis of the study was placed on areas of planned development based on a previous *Tentative Map* which included the southern half of the overall property. The current planned development is proposed in the northern half of the property.

The exploratory trenches were performed to determine the general extent of surficial deposits in selected areas and to assist in refining geologic mapping performed during the reconnaissance. The large-diameter borings were conducted to evaluate the stability of the geologic formations. The seismic refraction surveys and air-track borings were conducted to evaluate rippability in areas where deep cuts are proposed in granitic rock or Stadium Conglomerate. Details of the field investigations, as well as boring and trench logs and the results of the seismic refraction surveys, are presented in Appendices A through E. It should be noted that the boring and trench identification numbers are not

necessarily in sequential order since excavations were being performed in other areas of Fanita Ranch not covered by the current *Vesting Tentative Map/Preliminary Grading Plan*.

Laboratory tests were performed on selected representative soil samples obtained during the field investigation for the overall Fanita Ranch project to evaluate pertinent physical properties of the soils encountered. The laboratory information was used in engineering analyses and to assist in providing recommendations for site grading and development. Details of the laboratory tests and a summary of the test results are presented in Appendices F and G.

The base map used to depict the soil and geologic conditions consisted of AutoCAD files of the proposed grading entitled *Fanita Ranch – Vesting Tentative Map/Preliminary Grading Plan*, Sheets 1 through 37, prepared by Hunsaker & Associates San Diego, Inc., Revision 5 dated March 27, 2020 (see Geologic Map, Figures 2 and 3, map pocket). The Geologic Map depicts the configuration of the property, proposed development, existing topography, mapped geologic contacts and the approximate locations of the exploratory excavations and seismic traverses. The conclusions and recommendations presented herein are based on an analysis of the data obtained from the exploratory field investigation, laboratory tests, and our experience with similar soil and geologic conditions.

2. SITE AND PROJECT DESCRIPTION

The Fanita Ranch Specific Plan consists of approximately 2,638 acres of land located in the northwest quadrant of the City of Santee in eastern San Diego County. The southern approximately half of the overall property will be undeveloped and dedicated as an open space ecological preserve except for a 32-acre Special Use Area. Proposed Fanita Commons, Orchard Village and Vineyard Village occupy the northern approximately half of the property, north of a 150-foot-wide, east-west trending, San Diego Gas and Electric transmission easement.

The Specific Plan area is bordered by the City of Santee residential neighborhoods to the south and the unincorporated residential communities of Lakeside and Eucalyptus Hills to the east. Sycamore Canyon Open Space Preserve and Goodan Ranch Regional Park border the north and west property boundaries, respectively. The overall Fanita Ranch development plan consists of mass grading to create various residential components, as well as retail, commercial, school, fire station, parks and active adult community improvements. Associated roadways and infrastructure improvements are also proposed.

The preliminary earthwork exhibit indicates that grading will consist of a cut and fill volume on the order of approximately 26,575,000 cubic yards. Cut and fill depths on the order of 160 feet and 145 feet, respectively, are anticipated. Fill slopes are designed at 2:1 (horizontal:vertical) or flatter, and cut

slopes 1.5:1 or flatter. Maximum slope heights are on the order of 105 feet for cut slopes and 275 feet for fill slopes. Following are specific site and project descriptions for each village.

2.1 Fanita Commons

Fanita Commons is proposed north of Orchard Village and east of Sycamore Canyon. Topographically, the development area occupies a broad, northwest trending valley with a central, conical-shaped promontory labeled as “Passive Park” on the *Vesting Tentative Map/Preliminary Grading Plan*. Planned development consists of grading to create pads for an active adult neighborhood, K-8 school site, a community park, a working farm and mixed-use Village Center. The mixed-use Village Center will allow for retail, residential, congregational care facilities and civic uses, including a fire station.

Geologically, Fanita Commons is relatively benign with terrace deposits associated with Sycamore Creek occupying the western development margin and topsoils, granitic, and gabbroic rock underling the eastern approximately two-thirds of the proposed development. A remnant of Friars Formation underlies the general vicinity of the “School Site” and “Park Site” NP-8. Two alluvial-filled natural drainages cross the village in a generally east-west direction.

A review of a preliminary earthwork exhibit indicates that grading will primarily consist of filling operations to create large sheet-graded pads that will support commercial/retail improvements and the active adult community. A storm water basin is also proposed on the western development margin. We anticipate that a significant portion of the embankment material that will create Fanita Commons will originate from the large excavation in Stadium Conglomerate in Orchard Village which will provide adequate materials for capping and slope construction. It appears that relatively significant excavations are also planned along the northeast and east boundary of Fanita Commons.

The primary geotechnical consideration for grading in Fanita Commons is the extent of remedial grading that will be required to remove and compact potentially compressible surficial deposits beneath the proposed embankments and the rippability of the rock excavation planned in the northeast corner of the development.

2.2 Orchard Village

Orchard Village is proposed for single family and multi-family land uses which includes a Village Center Overlay that provides the opportunity for neighborhood-serving retail uses such as shops, corner markets, retail services and similar uses. Orchard Village is situated directly south of Sycamore Creek and north of an ephemeral stream that conveys runoff from the eastern foothills westward to Sycamore Canyon. These drainages contain relatively shallow alluvial deposits; however, development generally does not encroach into these areas.

Topographically, the central portion of the village exhibits a series of east-west trending ridges dissected by moderately steep-sided canyons and tributaries. The robust topography is characteristic of terrain underlain by the Stadium Conglomerate formation which consists of dense to very dense sandy gravel, cobble and boulders. This formation occurs at the site generally above elevation 675 Mean Sea Level (MSL) and has been mined throughout San Diego County for its aggregate properties.

The Friars Formation underlies the Stadium Conglomerate and forms the gentle slopes at the base of hillsides generally below elevation 675 MSL. This formation consists of weak claystones, siltstones and sandstones and can contain weak bedding planes which typically require mitigation when exposed in slopes. The sheared bedding planes are also the reason for ancient landslides that are present along the natural north facing slope in the north portion of the proposed village. To a lesser extent, ancient landslides are also present in the southern portion of the proposed development along the south facing natural slope. The eastern portion of Orchard Village is underlain by granitic rock.

Based on a review of the preliminary exhibits, proposed grading in Orchard Village generally consists of significant excavations in the central portions of the site and fill placement along the flanks of the ridges. The majority of the excavations will occur in Stadium Conglomerate which will provide adequate materials for capping of the lots and grading of shear keys and buttresses in the event that stabilization procedures are necessary. The primary geotechnical focus for future studies in Orchard Village will be in areas underlain by the Friars Formation and ancient landslides to evaluate the extent of remedial grading that may be necessary in proposed development areas.

2.3 Vineyard Village

Vineyard Village occupies the northeast approximately one-third of the overall Fanita Ranch property and is situated at the highest elevations of the site. The village is south of the Sycamore Canyon Open Space Preserve, west of Eucalyptus Hills, east of Sycamore Canyon, and north of the 150-foot-wide, east-west trending, San Diego Gas and Electric transmission easement. The north and west project boundaries abut undeveloped natural open space, whereas minor residential development occurs along the south and east margins.

Proposed development consists of multi-family uses arranged around a series of parks and specifically designed streets that provide a unique character to each neighborhood. The multi-family neighborhood use includes a Village Center Overlay which provides the opportunity for neighborhood-serving retail uses such as corner markets, retail services and similar uses. The remaining portions of the village consist of single family homes of varying lot sizes surrounded by open space, vineyards, trails, and parks. A water tank (WT-1) is located in open space the northeast corner of Vineyard Village. A second water tank (WT-2) is located in open space near the extension of Cuyamaca Boulevard southwest of Vineyard Village.

Topographically, Vineyard Village is characterized by a series of generally north-south, and northeast-southwest trending ridges dissected by moderately steep-sided canyons and tributaries. The site topography is characteristic of the geologic units present where surface morphology is dictated by the resistance of each unit to erosion. As such, moderately steep to steep lobate ridges comprise the majority of areas that expose Stadium Conglomerate whereas generally conical topography occurs in areas underlain by granitic and gabbroic rock. Alluvium is present in the drainages. The highest elevation is a series of peaks located in the southern portion of the site at approximately 1,200 feet MSL. The lowest elevation is approximately 630 feet MSL in the northwest portion of the property yielding a maximum relief of approximately 570 feet.

Natural runoff occurs through a series of west and southwest draining tributaries that originate from a prominent north-south trending ridge along the eastern property margin. Less prominent tributaries convey runoff southeast toward Eucalyptus Hills from the eastern flank of the ridge. The majority of the surface runoff discharges into a broad valley west of Vineyard Village which ultimately joins Sycamore Canyon. Vegetation consists of natural grasses, chaparral, and several Sycamore trees in the northwest corner of the property.

A review of the *Vesting Tentative Map/Preliminary Grading Plan* indicates that significant excavations are proposed in Stadium Conglomerate and gabbroic rock along the ridge tops and filling in canyon areas. The primary geotechnical considerations for grading in Vineyard Village are the excavation characteristics of the Stadium Conglomerate and underlying granitic and gabbroic rocks, and the thickness and extent of surficial deposits (alluvium, colluvium, etc.) requiring remedial grading.

The locations and descriptions of the site and proposed development are based on a site reconnaissance, a review of the available plans, and our understanding of the project. If project details vary significantly from those described, Geocon Incorporated should be consulted to provide additional recommendations and/or analysis.

2.4 Special Use Area

A 32-acre Special Use Area is planned south of Orchard Village in the southwest portion of the overall Fanita Ranch property. Specifically, the area is west of the northern terminus of Carlton Hills Boulevard and Padre Dam's existing 6.0 MG water reservoir. The site was previously graded during repair of the Oak Hills Landslide in the late 1970's/early 1980's and consists of four relatively level sheet-graded pads.

Since the Special Use Area was part of a geotechnical stabilization measure, no grading or introduction of irrigation water into the soil is permitted. We understand that future use of this area

may include a solar farm, recreational vehicle and boat storage, above-ground agriculture with water collection and reuse infrastructure that would preclude introduction of water into the soil, or other similar uses. A 1.60-acre Mini-Park is also proposed along the west side of Carlton Hills Boulevard south of the water reservoir that would include a trail staging and parking area. As long as there is no grading, or introduction of water into the soils in conjunction with the implementation of the proposed uses, the Special Use Area is suitable for the proposed uses.

3. PREVIOUS GEOTECHNICAL STUDIES

Previous geotechnical studies were performed by Leighton & Associates on the Fanita Ranch property beginning in 1979. Selected reports from the previous studies were utilized during this investigation to assist in evaluating the soil and geologic conditions (see *List of References*). These involved preparation of a geotechnical land use feasibility study (1986), and geotechnical investigation reports (1987). The reports presented subsurface work from 1981 through 1986, which at that time were referred to as Fanita Ranch Phases 1 through 6. A compilation of these reports was prepared by Leighton & Associates (1988) for submittal with a previous Specific Plan.

4. SOIL AND GEOLOGIC CONDITIONS

Seven surficial deposits and three geologic formations were encountered during the field investigations. The surficial soil deposits consist of undocumented fill, topsoil, colluvium, alluvium, debris flow deposits, landslide deposits and Terrace Deposits. Formational units include the Eocene-age Stadium Conglomerate and Friars Formation, and Cretaceous-age granitic rocks. Each of the surficial soil types and geologic units encountered is described below in order of increasing age. The approximate extent of the deposits, excluding topsoil, are shown on the *Geologic Map*. Geologic cross-sections were constructed through several areas of the site for use in the geologic interpretation. The geologic cross-sections are included on Figures 4 through 7.

4.1 Undocumented Fill (Qudf)

Undocumented fill is mapped north of the Padre Dam sewage treatment facility along the southwest flank of Fanita Commons. This deposit is beyond the proposed development footprint and is not expected to be encountered during site development.

4.2 Topsoil (Unmapped)

Topsoils blanket the majority of the site and range in thickness from approximately 1 to 3 feet. The topsoils are characterized as loose to medium dense, brown to dark brown, silty/clayey fine to medium sands and sandy clays. Topsoils which overlie the Stadium Conglomerate are generally thinner, and have a greater percentage of gravel and cobble fragments. Topsoil deposits are considered unsuitable in their present condition and, will require removal and compaction in areas planned to receive

structural fill and/or settlement sensitive structures. The clayey topsoils possess a medium to high expansion potential and should be placed in deeper fill areas.

4.3 Alluvium (Qal)

Alluvial soils cover portions of the property and were found within drainage and tributary channels throughout the site. These deposits consist of relatively loose/soft, silty/clayey sands and sandy clays with varying amounts of gravel and cobble derived from the bedrock units. The alluvial deposits are poorly consolidated, and compressible, and will require remedial grading. The anticipated maximum depth of removal based on the exploratory excavations is on the order of 11 feet (Trench No. T-88). Deeper removals may be encountered in the main drainage areas.

4.4 Colluvium (Qcol)

Colluvial deposits were encountered in the gentle, low-lying slope areas near alluvial drainages primarily overlying the Friars Formation. Colluvial materials are also anticipated to overlie landslide deposits, and within the graben zone near the head and margins of the slides. Where observed, the maximum colluvium thickness was on the order of 15 feet (Boring No. B-65). These deposits generally possess a medium to high expansion potential, are poorly consolidated and will require remedial grading in areas of planned development.

4.5 Alluvium/Debris Flow Deposits (Qal/Qdf)

Alluvial soils, and to a lesser extent debris flow material, cover portions of the property and were found within drainage and tributary channels throughout the site. For the purpose of this study the alluvium and debris flow materials in Vineyard Village have not been differentiated. These deposits consist of relatively loose/soft, silty/clayey sands and sandy clays with varying amounts of gravel and cobble derived from the Stadium Conglomerate. An evaluation of site geomorphology suggests that the debris flow deposits originated from the higher elevations of the site along steep slopes within the Stadium Conglomerate, and followed pre-existing alluvial channels.

The alluvial and debris flow deposits are poorly consolidated and compressible, and will require remedial grading. The anticipated maximum depth of removal, based on the exploratory excavations, is approximately 5 feet (Trench Nos. T-161, T-162, and T-167). Deeper removals may be encountered in the main drainage areas.

4.6 Landslide Deposits (Qls)

A complex distribution of ancient landslides with varying thickness and geometry were identified during this study and previous investigations. The landslide deposits primarily occur along north and south facing slopes of a prominent ridge in the south-central portion of the site (Orchard Village). The

extent and distribution of these deposits is shown on the *Geologic Map*. Geologic cross-sections through the landslides are depicted on Figures 4 through 7.

Nearly all of the landslides mapped at the site occur along relatively gentle slopes within the Friars Formation and exhibit a characteristic morphology of steep back-scarp areas and bulging, hummocky, distorted topography, as well as, deflected drainages. Some slide areas expressed a more subdued topography suggestive of incipient landslide development. The landslide deposits are primarily characterized as deep-seated, relatively intact, block-glide type movements (Qls along section A-A'), or shallow to deep-seated bedrock slides with a varying degree of slip plane development and slide mass disturbance.

The landsliding appears to have occurred along inherently weak, sheared, low angle bedding planes (bedding plane shears), or weak, thinly laminated claystones within the Friars Formation. This is suggested by the relatively uniform, near horizontal slip surfaces typically observed at the base of the slides, and because of a general correlation within exploratory borings throughout the Fanita Ranch property between the elevation at which bedding plane shears occur in bedrock material, and the elevation of basal slip planes in landslide deposits.

The prominent landslide complex along the north facing slope north of Orchard Village appears to exhibit a variation of deep seated block-glide geometry, and shallow slump-type slide movements (see Cross Section A-A'). The difference in slip plane elevation across the slide complex suggests that landsliding was controlled by several different structural continuities (including the occurrence of underlying granitic rock) and that failure along the slope likely occurred as several episodes of slope instability. A similar variation in landslide elevation exists in the canyon area south of Orchard Village.

The maximum thickness of landslide material encountered was approximately 33 feet (Boring No. B-60). However, these deposits typically thicken toward their "head" which will yield a greater thickness. The landslide debris varied from medium dense sandstone/claystone blocks to a variable mixture of intensely sheared and pulverized claystone breccia suspended in a stiff clay matrix. Highly disturbed, cobbly clay mixtures resembling debris flow materials were also encountered in portions of several borings (Boring No. B-59).

The *Vesting Tentative Map/Preliminary Grading Plan* for Orchard Village proposes development within the landslide areas mapped on the site. The cross-sections depict the relationship between the proposed development and the existing geologic conditions. Although some geotechnical information was obtained during previous studies, additional field work, engineering analysis and an update geotechnical report will be necessary to address grading these areas as project plans progress. Remedial grading measures such as complete removal and compaction of landslide materials or grading of shear keys and/or buttresses is anticipated in these areas.

4.7 Terrace Deposits (Qt)

Terrace Deposits were encountered along the flanks of Sycamore Creek (Trench No. T-87). These deposits are relatively limited in extent and consist of locally cemented, medium dense to dense, damp to moist, orange/grayish brown gravelly cobble conglomerate and clayey sand. In several areas, the Terrace Deposits were not differentiated from the conglomeratic facies of the Friars Formation. Terrace Deposits will likely be encountered during grading for the westernmost portion of Fanita Commons and Orchard Village.

4.8 Stadium Conglomerate (Tst)

The Eocene-age Stadium Conglomerate conformably overlies the Friars Formation in Orchard Village at an elevation estimated to range from approximately 620 to 670 feet MSL. The contact is estimated due to the presence of a conglomeratic facies within the upper portions of the Friars Formation making it difficult to identify the Stadium/Friars boundary in portions of the site. The Stadium Conglomerate also unconformably overlies the granitic rock units at varying elevations in Vineyard Village and comprises the majority of the development area (easternmost approximately two-thirds).

Geomorphically, the Stadium Conglomerate forms the characteristic resistant, dissected lobate ridges within the upper elevations of both Orchard and Vineyard Village. Localized, steeply eroded scars occur within this formation where debris flows originated at the head of tributary canyons. As encountered in exploratory excavations, this deposit generally consists of dense to very dense, light brown to orange-brown, sandy to clayey, gravel and cobble conglomerate interbedded silty/clayey sands (Trench No. T-100).

Moderately heavy to very heavy ripping and possible blasting should be anticipated during grading within the Stadium Conglomerate due to randomly occurring highly cemented zones. Borings performed during this study in other areas of Fanita Ranch confirmed the presence of these zones. When excavated, the cemented zones will also result in handling difficulties during fill placement. Pneumatic air percussion borings (air-track) and seismic refraction traverses were also performed where deep cuts are proposed in Stadium Conglomerate in Orchard and Vineyard Village. The results of the traverses and borings are presented in Appendices A, B and D. The boring and seismic lines are shown on the *Geologic Map*.

Generally, the conglomerate is suitable as a capping material; however, due to its sometimes clayey soil matrix, the conglomerate may possess a medium expansion potential. The Stadium Conglomerate, in either a natural or properly compacted condition, generally possesses good slope stability and bearing capacity characteristics.

4.9 Friars Formation (Tf)

The Eocene-age Friars Formation occurs throughout the south, central and southwestern portions of the overall property. This formation consists of relatively flat-lying lagoonal and alluvial claystone, sandstone, and conglomerate units deposited on an irregular erosion surface formed on crystalline basement rock of the Southern California Batholith. Specifically, weak, waxy claystone, and thinly laminated siltstone/claystone, sandstone, and conglomerate occur at the site below an approximate elevation of 620 to 670 MSL, with the exception of the western portion of Orchard Village, which is dominated by a relatively thick conglomeratic facies. The inherently weak nature of the claystones within this formation, in combination with the occurrence of bedding plane shear zones, has resulted in the landsliding on the property.

With the exception of the sandstone, and portions of the conglomeratic facies, soils derived from the Friars Formation typically possess a medium to high expansion potential and low shear strength. Where exposed in cut slopes, the claystone facies of the Friars Formation can be prone to surficial instability, and will require stability fills. Bedrock creep zones and areas of deep weathering are also common within this unit. Where weak, waxy, or highly weathered portions of the Friars Formation are exposed, deeper remedial grading will be required to provide a competent surface to support the fills.

Bedding-plane shears are relatively common within the Friars Formation and are significant in that they represent inherent planes of weakness within the formation. As the term implies, these shear zones are typically parallel to the bedding and are characterized by thin seams of very soft, wet, remolded plastic clay. A possible bedding plane shear was observed in Boring No. B-55 excavated in the vicinity of Lot 12 (adjacent to OS-27 in Orchard Village). The suggested shear zone occurs at an elevation of approximately 630 MSL and may affect the stability of the proposed fill slope to the rear of the lot. Due to the uncertainty of the extent of this feature, it is recommended that this area be further evaluated when grading plans are finalized, or during site construction.

Where bedding plane shears are anticipated to "daylight" in cut slopes, stabilization measures, such as drained stability fills or buttresses, are recommended. In the event that bedding plane shears are encountered during site grading in cut slopes, stabilization measures may be required. All cut slopes and fill slope keyway excavations within the Friars Formation should be evaluated by an engineering geologist during grading to verify the absence of bedding plane shears.

4.10 Granitic Rock (Kgr/Kgb)

Cretaceous-age granitic rock of the Southern California Batholith is exposed over a large portion of the northern one-half of the property (Fanita Commons and Vineyard Village) and directly underlay the Friars Formation and to a lesser extent Stadium Conglomerate. Granitic rock is the oldest geologic unit in the region and is believed to underlie the entire Fanita Ranch project at depth. Field

classification indicates that two units of differing composition occur in the area, each characterized by a different mineralogy, outcrop morphology, and topsoil color.

White, bouldery outcrops of granodiorite were mapped in the southeast area of the site, whereas dark gray, less prominent surface exposures of gabbroic rock comprise the east central property margin. Distinct, reddish-brown topsoil distinguishes the gabbroic unit from outcrops of granodiorite. The residual soils derived from the weathering of both granitic units often consist of medium to high expansive, sandy clays with abundant rock fragments. Granitic units generally exhibit excellent bearing characteristics in both a natural or properly compacted condition. Cut slopes excavated in granitic rock, with an inclination of 1.5:1 or flatter, should be stable if free from adversely oriented fractures and/or joints.

It is anticipated that several of the proposed cuts will encounter hard granitic rock. To evaluate the rippability characteristics of the rock, a geophysical survey consisting of seismic refraction traverses was performed in Fanita Commons and Vineyard Village. The traverses were conducted with an EG&G Geometrics 1225-model, 12-channel seismograph unit. The traverses were 100 feet long and were performed in both a forward and reverse direction. Typically, the depth evaluated by a seismic survey is on the order of one-third of the traverse length which generally correlates to 30 feet for a 100-foot traverse.

In addition, hydraulic rotary percussion borings (generically referenced herein as air-track borings) were drilled in select areas where significant excavations were proposed. Concentrated rock outcroppings precluded access to several proposed excavation areas. The borings were advanced using an Ingersoll Rand ECM-370 drill rig equipped with a 3-inch and 4-inch drill bit (3-inch for Stadium Conglomerate and 4-inch for granitic/gabbroic rock). A total of 62 air-track borings were drilled.

In general, the air-track borings were advanced to a maximum depth of 70 feet below original ground surface. Several borings were terminated before reaching the proposed depth of excavation due to collapsing holes within the Stadium Conglomerate. The locations of the air-track borings are shown on the *Geologic Map* and the penetration rates for the various areas are contained in Appendices B and C.

Based on a review of the geophysical data (seismic refraction), it appears that the depth to non-rippable material is variable. Excavations beyond the depths indicated on the tables in Appendices A and D, at those locations, will likely require blasting to efficiently excavate the materials. Prospective grading contractors should use their own judgment in reviewing the data and determining the threshold between rippable and non-rippable rock. It should be noted that the refraction signatures for several of the seismic traverses presented herein appeared to be inaccurate and raised concerns regarding the validity of the data. It is possible that the erratic data can be attributed to a variable weathering pattern

within the rock, and possibly corestones beneath the traverses altering seismic velocities. The approximate locations of the seismic refraction traverses are shown on the *Geologic Map*.

5. GROUNDWATER/SEEPAGE

Perched groundwater or seepage was encountered within alluvial drainage and hillside areas. The groundwater/seepage in drainage courses is presumed to be associated with surface runoff of rainwater along the natural watershed. Seepage conditions were also encountered in bedrock materials, landslide materials, and at the base of landslide areas. Additionally, relatively minor natural surface seeps were observed in other portions of the property along the Friars Formation/Stadium Conglomerate contact.

Subdrain systems will be necessary in areas of proposed development to intercept and convey seepage migrating along impervious strata. In particular, the main drainages, stability/buttress fill areas, and possibly where impervious layers daylight near the ultimate graded surface, will require subdrains. Specific subdrain locations and design details should be provided with the detailed grading plans for the site. A typical subdrain detail is presented on Figure 8.

A static, near-surface groundwater table was not encountered during this study. The existing perched ground water levels in alluvial areas can be expected to fluctuate seasonally and may affect remedial grading. In this regard, remedial grading may encounter wet soils and excavation and compaction difficulty particularly if construction is planned during the winter months. It should also be noted that areas where perched water or seepage was not encountered during this study may exhibit groundwater during rainy periods.

6. GEOLOGIC STRUCTURE

The Friars Formation, and to a lesser extent Stadium Conglomerate, is presumed to have been deposited unconformably on an irregular crystalline bedrock surface yielding a variable contact geometry. Bedding within the Eocene-age sediments is nearly horizontal or gently dipping within the site limits. Based on topographic interpretation and the exploratory excavations, the Friars Formation/Stadium Conglomerate contact dips generally south-southwest, and varies in elevation from approximately 620 to 670 MSL. Regional relationships shown on published geologic maps of the area indicate that the contact dips toward the west. Locally, bedding dip direction can be expected to vary, or even reverse, depending on the configuration of ancient buried topography or other geologic structures. High-angle depositional contacts are also common between a number of sedimentary formations.

7. GEOLOGIC HAZARDS

7.1 Ancient Landslides

The landslide deposits within areas of proposed development can be mitigated using generally accepted remedial grading techniques consisting of partial or complete removal and compaction of the deposits or shear keys and buttresses. Stability fills or buttresses will also be required where landslides are not present but where weak claystone beds, bedding plane shears, or thick surficial soil deposits are exposed in slope excavations. Such areas should be generally limited to where the Friars Formation will be exposed in cut slopes.

7.2 Debris Flow Deposits

These deposits are of limited extent and consist of an accumulation of topsoil, colluvium, and debris derived from formational "parent material" near the base of moderate to steep slopes which have resulted from rapid flow of saturated near-surface soils. High rainfall, steep slopes, loss of vegetation cover, and thick overburden are the main factors contributing to the occurrence of debris flows. The primary difference, in terms of the potential for activation, between ancient landslides and debris flows is that, by definition, debris flows do not possess a basal slip surface. Thus, they are much less likely to become reactivated by grading than ancient landslides. In areas of proposed development, mitigation of debris flow deposits will be similar to that for alluvium and colluvium, and the presence of these materials is not likely to impact development.

A qualitative evaluation was performed to assess debris flow potential in areas possessing similar geology and geomorphology to that which is postulated to have been present prior to the existing debris flow deposits. An identification of moderately steep source areas within the Stadium Conglomerate which could possess relatively thick overburden soils was performed and compared to the location of proposed development. The evaluation indicated that the majority of areas possibly possessing these characteristics were either away from proposed development, or positioned such that the project grading will mitigate the potential for these deposits to impact development. It should be noted, however, that several areas may require further evaluation prior to finalizing the project grading plans.

7.3 Faulting and Seismicity

Based on our reconnaissance and a review of published geologic maps and reports, the site is not located on any known "active," "potentially active" or "inactive" fault traces as defined by the California Geological Survey (CGS).

The Newport-Inglewood Fault and Rose Canyon Fault Zone, located approximately 15 miles west of the site, are the closest known active faults. The CGS considers a fault seismically active when

evidence suggests seismic activity within roughly the last 11,000 years. The CGS has included portions of the Rose Canyon Fault Zone within an Alquist-Priolo Earthquake Fault Zone.

7.4 Seismicity-Deterministic Analysis

We used the computer program *EZ-FRISK* (Version 7.65) to determine the distance of known faults to the site and to estimate ground accelerations at the site for the maximum anticipated seismic event.

According to the results of the computer program *EZ-FRISK* (Version 7.65), 7 known active faults are located within a search radius of 50 miles from the property. We used acceleration attenuation relationships developed by Boore-Atkinson (2008) NGA USGS2008, Campbell-Bozorgnia (2008) NGA USGS, and Chiou-Youngs (2008) NGA in our analysis. The nearest known active faults are the Newport-Inglewood and Rose Canyon Fault Zones, located approximately 15 miles west of the site, respectively, and are the dominant sources of potential ground motion. Table 7.4 lists the estimated maximum earthquake magnitudes and PGA's for the most dominant faults for the site location calculated for Site Class D as defined by Table 1613.3.2 of the 2016 California Building Code (CBC).

**TABLE 7.4
DETERMINISTIC SPECTRA SITE PARAMETERS**

Fault Name	Distance from Site (miles)	Maximum Earthquake Magnitude (Mw)	Peak Ground Acceleration		
			Boore-Atkinson 2008 (g)	Campbell-Bozorgnia 2008 (g)	Chiou-Youngs 2008 (g)
Newport-Inglewood	15	7.5	0.23	0.17	0.21
Rose Canyon	15	6.9	0.19	0.15	0.16
Elsinore	26	7.85	0.19	0.13	0.16
Coronado Bank	28	7.4	0.16	0.10	0.12
Palos Verdes Connected	28	7.7	0.17	0.12	0.14
Earthquake Valley	31	6.8	0.12	0.08	0.07
San Jacinto	47	7.88	0.13	0.08	0.11

7.5 Seismicity-Probabilistic Analysis

We used the computer program *EZ-FRISK* (version 7.65) to perform a probabilistic seismic hazard analysis. *EZ-FRISK* operates under the assumption that the occurrence rate of earthquakes on each mapped Quaternary fault is proportional to the fault slip rate. The program accounts for earthquake magnitude as a function of rupture length. Site acceleration estimates are made using the earthquake magnitude and distance from the site to the rupture zone. The program also accounts for uncertainty in each of following: (1) earthquake magnitude, (2) rupture length for a given magnitude, (3) location of

the rupture zone, (4) maximum possible magnitude of a given earthquake, and (5) acceleration at the site from a given earthquake along each fault. By calculating the expected accelerations from considered earthquake sources, the program calculates the total average annual expected number of occurrences of site acceleration greater than a specified value. We utilized acceleration-attenuation relationships suggested by Boore-Atkinson (2008) NGA USGS 2008, Campbell-Bozorgnia (2008) NGA USGS 2008, and Chiou-Youngs (2008) NGA USGS 2008 in the analysis. Table 7.5 presents the site-specific probabilistic seismic hazard parameters including acceleration-attenuation relationships and the probability of exceedence for Site Class D.

**TABLE 7.5
PROBABILISTIC SEISMIC HAZARD PARAMETERS**

Probability of Exceedence	Peak Ground Acceleration		
	Boore-Atkinson, 2008 (g)	Campbell-Bozorgnia, 2008 (g)	Chiou-Youngs, 2008 (g)
2% in a 50 Year Period	0.44	0.36	0.42
5% in a 50 Year Period	0.34	0.27	0.30
10% in a 50 Year Period	0.27	0.22	0.23

While listing peak accelerations is useful for comparison of potential effects of fault activity in a region, other considerations are important in seismic design, including frequency and duration of motion and soil conditions underlying the site. Seismic design of the structures should be evaluated in accordance with the California Building Code (CBC) or City of Santee guidelines.

7.6 Liquefaction

The potential for liquefaction during a strong earthquake is limited to those soils which are in a relatively loose, unconsolidated condition and located below the water table. Due to the relatively high density and grain-size distribution characteristics of the fill and formational materials at the site, and the absence of a permanent water table in development areas, the risk of seismically induced soil liquefaction occurring at the property is considered to be very low.

8. CONCLUSIONS AND RECOMMENDATIONS

8.1 General

- 8.1.1 No soil or geologic conditions were encountered that would preclude the development of the subject villages, as presently planned, provided the recommendations of this report are followed. Additional field work, engineering analysis, and an update geotechnical report will be necessary to address grading in Orchard Village, and possibly other areas as project plans progress. In our opinion, the information contained herein is sufficient for the current *Vesting Tentative Map/Preliminary Grading Plan* (prepared by Hunsaker & Associates Revision 5 dated March 27, 2020) submittal to evaluate the site soil and geologic conditions as they relate to the proposed development.
- 8.1.2 The surficial soils (topsoil, alluvium, colluvium, debris flow and landslide deposits) are not considered suitable for the support of fill or structural loads in their present condition and will require remedial grading.
- 8.1.3 The geologic units encountered on the site have permeability characteristics and/or fracture systems that could be susceptible under certain conditions to groundwater seepage. The use of canyon subdrains and subdrains in buttress or stability fills (if recommended) will be necessary to mitigate the potential for adverse impacts associated with seepage conditions. Figure 8 depicts a typical subdrain detail. The final grading plans should show the location of all proposed subdrains.
- 8.1.4 Where clayey surficial deposits, or the claystone facies of the Friars Formation are exposed in proposed cut slopes, the slopes should be provided with a stability fill in accordance with Figure 9.
- 8.1.5 Development in the Special Use Area will be restricted due to the geotechnical mitigation that was performed in that area. The restrictions consist of no significant grading, or introduction of irrigation or storm water BMP infiltration into the soil. We understand that future use of this area may be a solar farm, recreational vehicle and boat storage, above-ground agriculture with water collection and reuse infrastructure, a 1.60-acre Mini-Park and associated basins. Geocon should review and approve the specific development plans for this area once the final design is complete.

8.2 Soil and Excavation Characteristics

- 8.2.1 The soil conditions encountered vary from low expansive, sandy gravel and cobble conglomerate and silty sands to highly expansive, clayey topsoils and claystones/siltstones

within the Friars Formation. The conglomerate bed within the upper portion of the Friars Formation, as well as the Stadium Conglomerate material, will likely require moderately heavy to very heavy ripping, and possible blasting due to the random occurrence of highly cemented zones. Oversize, cemented chunks of conglomerate are often generated and will require special handling and placement in fill areas. Excavating within the granitic materials will generally vary in difficulty with the depth of excavation. Blasting will likely be required for most excavations deeper than 10 to 20 feet. Prospective contractors should evaluate the data contained in this report and use their own interpretation in determining the threshold between rippable and non-rippable materials.

8.3 Terrace Drains

- 8.3.1 The use of terrace drains on cut or fill slopes exceeding 30 feet in height is not considered necessary to maintain gross stability of the slopes. Based on past experience with similar projects, properly-constructed and maintained terrace drains may reduce slope erosion, particularly on fill slopes. However, improperly-maintained terrace drains can result in significant slope erosion and possible slope distress. Terrace drains which are allowed to fill with debris may concentrate surface runoff down the slope face, resulting in deep, extensive erosion gullies. It is therefore recommended that the use of terrace drains planned for cut or fill slopes on the project be kept to a minimum, consistent with the general guidelines which follow.
- 8.3.2 For cut or fill slopes above developed lots, a terrace drain should be provided no higher than 30 feet above the toe of slope or alternatively a lined surface drain may be located along the toe of slope.
- 8.3.3 For cut or fill slopes above streets or non-building areas, terrace drains are not required.
- 8.3.4 All terrace drains should direct the flow of water into storm drains or other suitable drainage facilities. For "daylight" canyon fills, down-drains should be provided at the contact between fill and natural materials, to reduce erosion along the contact.
- 8.3.5 The above recommendations are presented as general guidelines only; other considerations may dictate the design of slope terrace drains. All terrace drains should be sized to accommodate the maximum flow of water anticipated from the drainage area above, under the design rainfall event.
- 8.3.6 It is recommended that terrace drains be constructed at a drainage gradient of at least 2 percent and steeper where practical. In addition, a maintenance program should be devised

and followed, which clearly designates the persons or agencies responsible for maintaining terrace drains within specific areas.

8.4 Grading

- 8.4.1 All grading should be performed in accordance with the attached *Recommended Grading Specifications* (Appendix H). Where the recommendations of this section conflict with Appendix H, the recommendations of this section take precedence. All earthwork should be observed and all fills tested for proper compaction by Geocon Incorporated.
- 8.4.2 Prior to commencing grading, a preconstruction conference should be held at the site with the owner or developer, grading contractor, civil engineer, and geotechnical engineer in attendance. Special soil handling and/or the grading issues can be discussed at that time.
- 8.4.3 Site preparation should begin with the removal of all deleterious material and vegetation. The depth of removal should be such that material exposed in cut areas or soils to be used as fill is relatively free of organic matter. Material generated during stripping and/or site demolition can remain on-site and be used for ecological restoration or landscaping purposes. Trash or any other objectionable materials not suitable for fills should be hauled off-site.
- 8.4.4 All potentially compressible surficial soils within areas of planned grading should be removed to firm natural ground and properly compacted prior to placing additional fill and/or structural loads. The actual extent of unsuitable soil removals should be determined in the field by the soil engineer and/or engineering geologist. Overly wet, surficial materials will require drying and/or mixing with drier soils to facilitate proper compaction.
- 8.4.5 The site should then be brought to final subgrade elevations with structural fill compacted in layers. In general, soils native to the site are suitable for re-use as fill if free from vegetation, debris and other deleterious material. Layers of fill should be no thicker than will allow for adequate bonding and compaction. All fill, including backfill and scarified ground surfaces, should be compacted to at least 90 percent of maximum dry density at approximately 2 percent over optimum moisture content, as determined in accordance with ASTM Test Procedure D 1557-12. Fill materials near and/or below optimum moisture content will require additional moisture conditioning prior to placing additional fill. Fills greater than 50 feet deep should be compacted to at least 93 percent relative compaction.
- 8.4.6 To reduce the potential for differential settlement, it is recommended that once building locations and final pad elevations are known, the cut portion of cut-fill transition building

pads be undercut at least 4 feet and replaced with properly compacted "very low" to "low" expansive fill soils. Where the thickness of the fill below the building pad exceeds 20 feet, the depth of undercut should be increased to one-fifth of the maximum fill thickness.

- 8.4.7 Where practical, the upper 4 feet of all building pads (cut or fill) and 12 inches in pavement areas should be composed of properly compacted or undisturbed formational "very low" to "low" expansive soils. The more highly expansive fill soils should be placed in the deeper fill areas and properly compacted. "Very low" to "low" expansive soils are defined as those soils that have an Expansion Index of 50 or less as defined by 2016 California Building Code (CBC) Section 1803.5.3. Rock or concretions greater than 12 inches in maximum dimension should not be placed within 10 feet of finish grade or 3 feet from the deepest utility. Rock and concretions greater than 6 inches in maximum dimension should not be placed within 3 feet of finish grade in building pad areas.
- 8.4.8 Where non-rippable hardrock or cemented concretions are exposed at finished pad grade, the pad should be undercut at least 3 feet to facilitate the installation of underground improvements. For street subgrade, consideration should be given to undercutting the street at least 2 feet below the deepest utility line.

8.5 Slope Stability

- 8.5.1 Slope stability analysis utilizing average drained direct shear strength parameters based on laboratory tests and experience with similar soil types in nearby areas indicates that the proposed fill slopes, constructed of on-site materials, should have calculated factors of safety of at least 1.5 under static conditions for both deep-seated failure and shallow sloughing conditions. This assumes that fill slopes higher than approximately 20 feet will incorporate the higher strength silty sands from the Friars Formation, granitic rock or the cobble conglomerate from the upper portion of the Friars Formation or from the Stadium Conglomerate. With the exception of cut slopes requiring a buttress due to landslide deposits or adversely oriented bedding plane shears, the proposed cut slopes were also found to possess a calculated factor of safety in excess of 1.5 for a deep-seated failure condition. Surficial and deep-seated slope stability calculations are presented on Figures 10 through 12.
- 8.5.2 The primary focus of future geotechnical studies in Orchard Village will be in areas underlain by the Friars Formation and ancient landslides. The investigation should further evaluate the geometry of the existing slides, their compression potential and stability as it relates to the proposed grading. Remedial grading recommendations relating to these areas will be provided in an update report with specific design information. For the purpose of this report, we have shown complete removal and compaction of landslide deposits on our cross sections.

- 8.5.3 Some of the cut slopes in the Friars Formation may expose relatively weak claystones which could result in localized slope instability. For such slopes, it is recommended that the slopes be cut back and provided with a drained stability fill similar to that depicted on Figure 9. The location of stability fills and outlet subdrains should be shown on the final grading plans once finish grades and storm drain locations have been established.
- 8.5.4 It is recommended that all cut slope excavations including buttresses, shear keys and stability fills be observed during grading by an engineering geologist to verify that soil and geologic conditions do not differ significantly from those anticipated.
- 8.5.5 The outer 15 feet (or a distance equal to the height of the slope, whichever is less) of fill slopes should be composed of properly compacted granular "soil" fill to reduce the potential for surficial sloughing. In general, soils with an Expansion Index of less than 90 or at least 35 percent sand size particles should be acceptable as "granular" fill. Soils of questionable strength to satisfy surficial stability should be tested in the laboratory for acceptable drained shear strength. Slopes should be compacted by backrolling with a loaded sheepsfoot roller at vertical intervals not to exceed 4 feet and should be track-walked at the completion of each slope such that the fill soils are uniformly compacted to at least 90 percent relative compaction to the face of the finished sloped.
- 8.5.6 All slopes should be landscaped with drought-tolerant vegetation, having variable root depths and requiring minimal landscape irrigation. In addition, all slopes should be drained and properly maintained to reduce erosion.

8.6 Seismic Design Criteria

- 8.6.1 We used the computer program *U.S. Seismic Design Maps*, provided by the USGS. Table 8.6.1 summarizes site-specific design criteria obtained from the 2016 California Building Code (CBC; Based on the 2015 International Building Code [IBC] and ASCE 7-10), Chapter 16 Structural Design, Section 1613 Earthquake Loads. The short spectral response uses a period of 0.2 seconds. The values presented in Table 8.6.1 are for the risk-targeted maximum considered earthquake (MCE_R). Based on soil conditions and planned grading, any structural improvements should be designed using a Site Class D. We evaluated the Site Class based on the discussion in Section 1613.3.2 of the 2016 CBC and Table 20.3-1 of ASCE 7-10.

**TABLE 8.6.1
2016 CBC SEISMIC DESIGN PARAMETERS**

Parameter	Value	2016 CBC Reference
Site Class	D	Section 1613.3.2
MCE _R Ground Motion Spectral Response Acceleration – Class B (short), S _S	0.893g	Figure 1613.3.1(1)
MCE _R Ground Motion Spectral Response Acceleration – Class B (1 sec), S ₁	0.346g	Figure 1613.3.1(2)
Site Coefficient, F _A	1.143	Table 1613.3.3(1)
Site Coefficient, F _V	1.708	Table 1613.3.3(2)
Site Class Modified MCE _R Spectral Response Acceleration (short), S _{MS}	1.021g	Section 1613.3.3 (Eqn 16-37)
Site Class Modified MCE _R Spectral Response Acceleration (1 sec), S _{M1}	0.591g	Section 1613.3.3 (Eqn 16-38)
5% Damped Design Spectral Response Acceleration (short), S _{DS}	0.681g	Section 1613.3.4 (Eqn 16-39)
5% Damped Design Spectral Response Acceleration (1 sec), S _{D1}	0.394g	Section 1613.3.4 (Eqn 16-40)

8.6.2 Table 8.6.2 presents additional seismic design parameters for projects located in Seismic Design Categories of D through F in accordance with ASCE 7-10 for the mapped maximum considered geometric mean (MCE_G).

**TABLE 8.6.2
2016 CBC SITE ACCELERATION PARAMETERS**

Parameter	Value, Site Class D	ASCE 7-10 Reference
Mapped MCE _G Peak Ground Acceleration, PGA	0.334g	Figure 22-7
Site Coefficient, F _{PGA}	1.166	Table 11.8-1
Site Class Modified MCE _G Peak Ground Acceleration, PGAM	0.39g	Section 11.8.3 (Eqn 11.8-1)

8.6.3 Conformance to the criteria for seismic design does not constitute any guarantee or assurance that significant structural damage or ground failure will not occur in the event of a maximum level earthquake. The primary goal of seismic design is to protect life and not to avoid all damage, since such design may be economically prohibitive.

8.7 Foundation and Concrete Slab-On-Grade Recommendations

8.7.1 The following foundation recommendations are for proposed one- to three-story residential structures. The foundation recommendations have been separated into three categories based

on either the maximum and differential fill thickness or Expansion Index. The foundation category criteria are presented in Table 8.7.1.

**TABLE 8.7.1
FOUNDATION CATEGORY CRITERIA**

Foundation Category	Maximum Fill Thickness, T (feet)	Differential Fill Thickness, D (feet)	Expansion Index (EI)
I	$T < 20$	--	$EI \leq 50$
II	$20 \leq T < 50$	$10 \leq D < 20$	$50 < EI \leq 90$
III	$T \geq 50$	$D \geq 20$	$90 < EI \leq 130$

8.7.2 We will provide final foundation categories for each building or lot after finish pad grades have been achieved and laboratory testing of the finish grade soil has been completed.

8.7.3 Table 8.7.2 presents minimum foundation and interior concrete slab design criteria for conventional foundation systems.

**TABLE 8.7.2
CONVENTIONAL FOUNDATION RECOMMENDATIONS BY CATEGORY**

Foundation Category	Minimum Footing Embedment Depth (inches)	Continuous Footing Reinforcement	Interior Slab Reinforcement
I	12	Two No. 4 bars, one top and one bottom	6 x 6 - 10/10 welded wire mesh at slab mid-point
II	18	Four No. 4 bars, two top and two bottom	No. 3 bars at 24 inches on center, both directions
III	24	Four No. 5 bars, two top and two bottom	No. 3 bars at 18 inches on center, both directions

8.7.4 The embedment depths presented in Table 8.7.2 should be measured from the lowest adjacent pad grade for both interior and exterior footings. The conventional foundations should have a minimum width of 12 inches and 24 inches for continuous and isolated footings, respectively. A typical wall/column footing detail is presented on Figure 13.

8.7.5 The concrete slabs-on-grade should be a minimum of 4 inches thick for Foundation Categories I and II and 5 inches thick for Foundation Category III. The concrete slabs-on-grade should be underlain by 4 inches and 3 inches of clean sand for 4-inch thick and 5-inch-thick slabs, respectively. Slabs expected to receive moisture sensitive floor coverings or used to store moisture sensitive materials should be underlain by a vapor inhibitor covered

with at least 2 inches of clean sand or crushed rock. If crushed rock will be used, the thickness of the vapor inhibitor should be at least 10 mil to prevent possible puncturing.

8.7.6 As a substitute, the layer of clean sand (or crushed rock) beneath the vapor inhibitor recommended in the previous section can be omitted if a vapor inhibitor that meets or exceeds the requirements of ASTM E 1745-97 (Class A), and that exhibits permeance not greater than 0.012 perm (measured in accordance with ASTM E 96-95) is used. This vapor inhibitor may be placed directly on properly compacted fill or formational materials. The vapor inhibitor should be installed in general conformance with ASTM E 1643-98 and the manufacturer’s recommendations. Two inches of clean sand should then be placed on top of the vapor inhibitor to reduce the potential for differential curing, slab curl, and cracking. Floor coverings should be installed in accordance with the manufacturer’s recommendations.

8.7.7 As an alternative to the conventional foundation recommendations, consideration should be given to the use of post-tensioned concrete slab and foundation systems for the support of the proposed structures. The post-tensioned systems should be designed by a structural engineer experienced in post-tensioned slab design and design criteria of the Post-Tensioning Institute (PTI) DC 10.5-12 *Standard Requirements for Design and Analysis of Shallow Post-Tensioned Concrete Foundations on Expansive Soils* or *WRI/CRSI Design of Slab-on-Ground Foundations*, as required by the 2016 California Building Code (CBC Section 1808.6.2). Although this procedure was developed for expansive soil conditions, it can also be used to reduce the potential for foundation distress due to differential fill settlement. The post-tensioned design should incorporate the geotechnical parameters presented in Table 8.7.3 for the particular Foundation Category designated. The parameters presented in Table 8.7.3 are based on the guidelines presented in the PTI DC 10.5 design manual.

**TABLE 8.7.3
POST-TENSIONED FOUNDATION SYSTEM DESIGN PARAMETERS**

Post-Tensioning Institute (PTI), Third Edition Design Parameters	Foundation Category		
	I	II	III
Thornthwaite Index	-20	-20	-20
Equilibrium Suction	3.9	3.9	3.9
Edge Lift Moisture Variation Distance, e_M (feet)	5.3	5.1	4.9
Edge Lift, y_M (inches)	0.61	1.10	1.58
Center Lift Moisture Variation Distance, e_M (feet)	9.0	9.0	9.0
Center Lift, y_M (inches)	0.30	0.47	0.66

- 8.7.8 Foundation systems for the lots that possess a foundation Category I and a “very low” expansion potential (expansion index of 20 or less) can be designed using the method described in Section 1808 of the 2016 CBC. If post-tensioned foundations are planned, an alternative, commonly accepted design method (other than PTI DC 10.5) can be used. However, the post-tensioned foundation system should be designed with a total and differential deflection of 1 inch. Geocon Incorporated should be contacted to review the plans and provide additional information, if necessary.
- 8.7.9 If an alternate design method is contemplated, Geocon Incorporated should be contacted to evaluate if additional expansion index testing should be performed to identify the lots that possess a “very low” expansion potential (expansion index of 20 or less).
- 8.7.10 The foundations for the post-tensioned slabs should be embedded in accordance with the recommendations of the structural engineer. If a post-tensioned mat foundation system is planned, the slab should possess a thickened edge with a minimum width of 12 inches and extend below the clean sand or crushed rock layer.
- 8.7.11 If the structural engineer proposes a post-tensioned foundation design method other than PTI DC 10.5:
- The deflection criteria presented in Table 8.7.3 are still applicable.
 - Interior stiffener beams should be used for Foundation Categories II and III.
 - The width of the perimeter foundations should be at least 12 inches.
 - The perimeter footing embedment depths should be at least 12 inches, 18 inches and 24 inches for foundation categories I, II, and III, respectively. The embedment depths should be measured from the lowest adjacent pad grade.
- 8.7.12 Our experience indicates post-tensioned slabs may be susceptible to excessive edge lift, regardless of the underlying soil conditions. Placing reinforcing steel at the bottom of the perimeter footings and the interior stiffener beams may mitigate this potential. The structural engineer should design the foundation system to reduce the potential of edge lift occurring for the proposed structures.
- 8.7.13 During the construction of the post-tension foundation system, the concrete should be placed monolithically. Under no circumstances should cold joints be allowed to form between the footings/grade beams and the slab during the construction of the post-tension foundation system unless designed by the structural engineer.

- 8.7.14 Category I, II, or III foundations may be designed for an allowable soil bearing pressure of 2,000 pounds per square foot (psf) (dead plus live load). This bearing pressure may be increased by one-third for transient loads due to wind or seismic forces.
- 8.7.15 Isolated footings, if present, should have the minimum embedment depth and width recommended for conventional foundations for a particular Foundation Category. The use of isolated footings, which are located beyond the perimeter of the building and support structural elements connected to the building, are not recommended for Category III. Where this condition cannot be avoided, the isolated footings should be connected to the building foundation system with grade beams.
- 8.7.16 For Foundation Category III, consideration should be given to using interior stiffening beams and connecting isolated footings and/or increasing the slab thickness. In addition, consideration should be given to connecting patio slabs, which exceed 5 feet in width, to the building foundation to reduce the potential for future separation to occur.
- 8.7.17 Special subgrade presaturation is not deemed necessary prior to placing concrete; however, the exposed foundation and slab subgrade soil should be moisture conditioned, as necessary, to maintain a moist condition as would be expected in any such concrete placement.
- 8.7.18 Where buildings or other improvements are planned near the top of a slope 3:1 (horizontal:vertical) or steeper, special foundation and/or design considerations are recommended due to the tendency for lateral soil movement to occur.
- For fill slopes less than 20 feet high, building footings should be deepened such that the bottom outside edge of the footing is at least 7 feet horizontally from the face of the slope.
 - When located next to a descending 3:1 (horizontal:vertical) fill slope or steeper, the foundations should be extended to a depth where the minimum horizontal distance is equal to $H/3$ (where H equals the vertical distance from the top of the fill slope to the base of the fill soil) with a minimum of 7 feet but need not exceed 40 feet. The horizontal distance is measured from the outer, deepest edge of the footing to the face of the slope. A post-tensioned slab and foundation system or mat foundation system can be used to reduce the potential for distress in the structures associated with strain softening and lateral fill extension. Specific design parameters or recommendations for either of these alternatives can be provided once the building location and fill slope geometry have been determined.
 - If swimming pools are planned, Geocon Incorporated should be contacted for a review of specific site conditions.

- Swimming pools located within 7 feet of the top of cut or fill slopes are not recommended. Where such a condition cannot be avoided, the portion of the swimming pool wall within 7 feet of the slope face be designed assuming that the adjacent soil provides no lateral support. This recommendation applies to fill slopes up to 30 feet in height, and cut slopes regardless of height. For swimming pools located near the top of fill slopes greater than 30 feet in height, additional recommendations may be required and Geocon Incorporated should be contacted for a review of specific site conditions.
- Although other improvements, which are relatively rigid or brittle, such as concrete flatwork or masonry walls, may experience some distress if located near the top of a slope, it is generally not economical to mitigate this potential. It may be possible, however, to incorporate design measures, which would permit some lateral soil movement without causing extensive distress. Geocon Incorporated should be consulted for specific recommendations.

8.7.19 The recommendations of this report are intended to reduce the potential for cracking of slabs and foundations due to expansive soil (if present), differential settlement of fill soil or soil with varying thicknesses. However, even with the incorporation of the recommendations presented herein, foundations, stucco walls, and slabs-on-grade placed on such conditions may still exhibit some cracking due to soil movement and/or shrinkage. The occurrence of concrete shrinkage cracks is independent of the supporting soil characteristics. Their occurrence may be reduced by limiting the slump of the concrete, proper concrete placement and curing, and by the placement of crack control joints at periodic intervals, in particular, where re-entrant slab corners occur.

8.7.20 Concrete slabs should be provided with adequate crack-control joints, construction joints and/or expansion joints to reduce unsightly shrinkage cracking. The design of joints should consider criteria of the American Concrete Institute (ACI) when establishing crack-control spacing. Additional steel reinforcing, concrete admixtures and/or closer crack control joint spacing should be considered where concrete-exposed finished floors are planned.

8.7.21 Geocon Incorporated should be consulted to provide additional design parameters as required by the structural engineer.

8.8 Retaining Walls and Lateral Loads Recommendations

8.8.1 Retaining walls not restrained at the top and having a level backfill surface should be designed for an active soil pressure equivalent to the pressure exerted by a fluid with a density of 35 pounds per cubic foot (pcf). Where the backfill will be inclined at 2:1 (horizontal:vertical), an active soil pressure of 50 pcf is recommended. These soil pressures assume that the backfill materials within an area bounded by the wall and a 1:1 plane extending upward from the base

of the wall possess an Expansion Index ≤ 50 . Geocon Incorporated should be consulted for additional recommendations if backfill materials have an EI > 50 .

- 8.8.2 Retaining walls shall be designed to ensure stability against overturning sliding, excessive foundation pressure and water uplift. Where a keyway is extended below the wall base with the intent to engage passive pressure and enhance sliding stability, it is not necessary to consider active pressure on the keyway.
- 8.8.3 Where walls are restrained from movement at the top, an additional uniform pressure of 8H psf (where H equals the height of the retaining wall portion of the wall in feet) should be added to the active soil pressure where the wall possesses a height of 8 feet or less and 12H where the wall is greater than 8 feet. For retaining walls subject to vehicular loads within a horizontal distance equal to two-thirds the wall height, a surcharge equivalent to two feet of fill soil should be added (total unit weight of soil should be taken as 130 pcf).
- 8.8.4 Soil contemplated for use as retaining wall backfill, including import materials, should be identified in the field prior to backfill. At that time Geocon Incorporated should obtain samples for laboratory testing to evaluate its suitability. Modified lateral earth pressures may be necessary if the backfill soil does not meet the required expansion index or shear strength. City or regional standard wall designs, if used, are based on a specific active lateral earth pressure and/or soil friction angle. In this regard, on-site soil to be used as backfill may or may not meet the values for standard wall designs. Geocon Incorporated should be consulted to assess the suitability of the on-site soil for use as wall backfill if standard wall designs will be used.
- 8.8.5 Unrestrained walls will move laterally when backfilled and loading is applied. The amount of lateral deflection is dependent on the wall height, the type of soil used for backfill, and loads acting on the wall. The wall designer should provide appropriate lateral deflection quantities for planned retaining walls structures, if applicable. These lateral values should be considered when planning types of improvements above retaining wall structures.
- 8.8.6 Retaining walls should be provided with a drainage system adequate to prevent the buildup of hydrostatic forces and should be waterproofed as required by the project architect. The use of drainage openings through the base of the wall (weep holes) is not recommended where the seepage could be a nuisance or otherwise adversely affect the property adjacent to the base of the wall. The above recommendations assume a properly compacted granular (EI ≤ 50) free-draining backfill material with no hydrostatic forces or imposed surcharge load. A typical retaining wall drainage detail is presented on Figure 14. If conditions

different than those described are expected, or if specific drainage details are desired, Geokon Incorporated should be contacted for additional recommendations.

- 8.8.7 In general, wall foundations having a minimum depth and width of one foot may be designed for an allowable soil bearing pressure of 2,500 psf, provided the soil within three feet below the base of the wall has an Expansion Index ≤ 90 . The recommended allowable soil bearing pressure may be increased by 300 psf and 500 psf for each additional foot of foundation width and depth, respectively, up to a maximum allowable soil bearing pressure of 4,000 psf.
- 8.8.8 The proximity of the foundation to the top of a slope steeper than 3:1 could impact the allowable soil bearing pressure. Therefore, Geokon Incorporated should be consulted where such a condition is anticipated. As a minimum, wall footings should be deepened such that the bottom outside edge of the footing is at least seven feet from the face of slope when located adjacent and/or at the top of descending slopes.
- 8.8.9 The structural engineer should determine the Seismic Design Category for the project in accordance with Section 1613.3.5 of the 2016 CBC or Section 11.6 of ASCE 7-10. For structures assigned to Seismic Design Category of D, E, or F, retaining walls that support more than 6 feet of backfill should be designed with seismic lateral pressure in accordance with Section 1803.5.12 of the 2016 CBC. The seismic load is dependent on the retained height where H is the height of the wall, in feet, and the calculated loads result in pounds per square foot (psf) exerted at the base of the wall and zero at the top of the wall. A seismic load of 20H should be used for design. We used the peak ground acceleration adjusted for Site Class effects, PGA_M , of 0.39g calculated from ASCE 7-10 Section 11.8.3 and applied a pseudo-static coefficient of 0.33.
- 8.8.10 For resistance to lateral loads, a passive earth pressure equivalent to a fluid density of 300 pcf is recommended for footings or shear keys poured neat against properly compacted granular fill soils or undisturbed formational materials. The passive pressure assumes a horizontal surface extending away from the base of the wall at least five feet or three times the surface generating the passive pressure, whichever is greater. The upper 12 inches of material not protected by floor slabs or pavement should not be included in the design for lateral resistance.
- 8.8.11 An ultimate friction coefficient of 0.35 may be used for resistance to sliding between soil and concrete. This friction coefficient may be combined with the passive earth pressure when determining resistance to lateral loads.

- 8.8.12 The recommendations presented above are generally applicable to the design of rigid concrete or masonry retaining walls having a maximum height of 12 feet. In the event that walls higher than 12 feet are planned, Geocon Incorporated should be consulted for additional recommendations.

8.9 Slope Maintenance

- 8.9.1 Slopes that are steeper than 3:1 (horizontal:vertical) may, under conditions that are both difficult to prevent and predict, be susceptible to near-surface (surficial) slope instability. The instability is typically limited to the outer 3 feet of a portion of the slope and usually does not directly impact the improvements on the pad areas above or below the slope. The occurrence of surficial instability is more prevalent on fill slopes and is generally preceded by a period of heavy rainfall, excessive irrigation, or the migration of subsurface seepage. The disturbance and/or loosening of the surficial soils, as might result from root growth, soil expansion, or excavation for irrigation lines and slope planting, may also be a significant contributing factor to surficial instability. It is, therefore, recommended that, to the maximum extent practical: (a) disturbed/loosened surficial soils be either removed or properly recompacted, (b) irrigation systems be periodically inspected and maintained to eliminate leaks and excessive irrigation, and (c) surface drains on and adjacent to slopes be periodically maintained to preclude ponding or erosion. It should be noted that although the incorporation of the above recommendations should reduce the potential for surficial slope instability, it will not eliminate the possibility, and, therefore, it may be necessary to rebuild or repair a portion of the project's slopes in the future.

8.10 Site Drainage and Moisture Protection

- 8.10.1 Adequate site drainage is critical to reduce the potential for differential soil movement, erosion and subsurface seepage. Under no circumstances should water be allowed to pond adjacent to footings. The site should be graded and maintained such that surface drainage is directed away from structures in accordance with 2016 CBC 1804.4 or other applicable standards. In addition, surface drainage should be directed away from the top of slopes into swales or other controlled drainage devices. Roof and pavement drainage should be directed into conduits that carry runoff away from the proposed structure.
- 8.10.2 In the case of basement walls or building walls retaining landscaping areas, a water-proofing system should be used on the wall and joints, and a Miradrain drainage panel (or similar) should be placed over the waterproofing. The project architect or civil engineer should provide detailed specifications on the plans for all waterproofing and drainage.

8.10.3 Underground utilities should be leak free. Utility and irrigation lines should be checked periodically for leaks, and detected leaks should be repaired promptly. Detrimental soil movement could occur if water is allowed to infiltrate the soil for prolonged periods of time.

8.11 Grading Plan Review

8.11.1 The geotechnical engineer and engineering geologist should review the grading plans prior to finalization to verify their compliance with the recommendations of this report and determine the necessity for additional comments, recommendations and/or analysis.

LIMITATIONS AND UNIFORMITY OF CONDITIONS

1. The firm that performed the geotechnical investigation for the project should be retained to provide testing and observation services during construction to provide continuity of geotechnical interpretation and to check that the recommendations presented for geotechnical aspects of site development are incorporated during site grading, construction of improvements, and excavation of foundations. If another geotechnical firm is selected to perform the testing and observation services during construction operations, that firm should prepare a letter indicating their intent to assume the responsibilities of project geotechnical engineer of record. A copy of the letter should be provided to the regulatory agency for their records. In addition, that firm should provide revised recommendations concerning the geotechnical aspects of the proposed development, or a written acknowledgement of their concurrence with the recommendations presented in our report. They should also perform additional analyses deemed necessary to assume the role of Geotechnical Engineer of Record.
2. The recommendations of this report pertain only to the site investigated and are based upon the assumption that the soil conditions do not deviate from those disclosed in the investigation. If any variations or undesirable conditions are encountered during construction, or if the proposed construction will differ from that anticipated herein, Geocon Incorporated should be notified so that supplemental recommendations can be given. The evaluation or identification of the potential presence of hazardous or corrosive materials was not part of the scope of services provided by Geocon Incorporated.
3. This report is issued with the understanding that it is the responsibility of the owner or his representative to ensure that the information and recommendations contained herein are brought to the attention of the architect and engineer for the project and incorporated into the plans, and the necessary steps are taken to see that the contractor and subcontractors carry out such recommendations in the field.
4. The findings of this report are valid as of the present date. However, changes in the conditions of a property can occur with the passage of time, whether they be due to natural processes or the works of man on this or adjacent properties. In addition, changes in applicable or appropriate standards may occur, whether they result from legislation or the broadening of knowledge. Accordingly, the findings of this report may be invalidated wholly or partially by changes outside our control. Therefore, this report is subject to review and should not be relied upon after a period of three years.

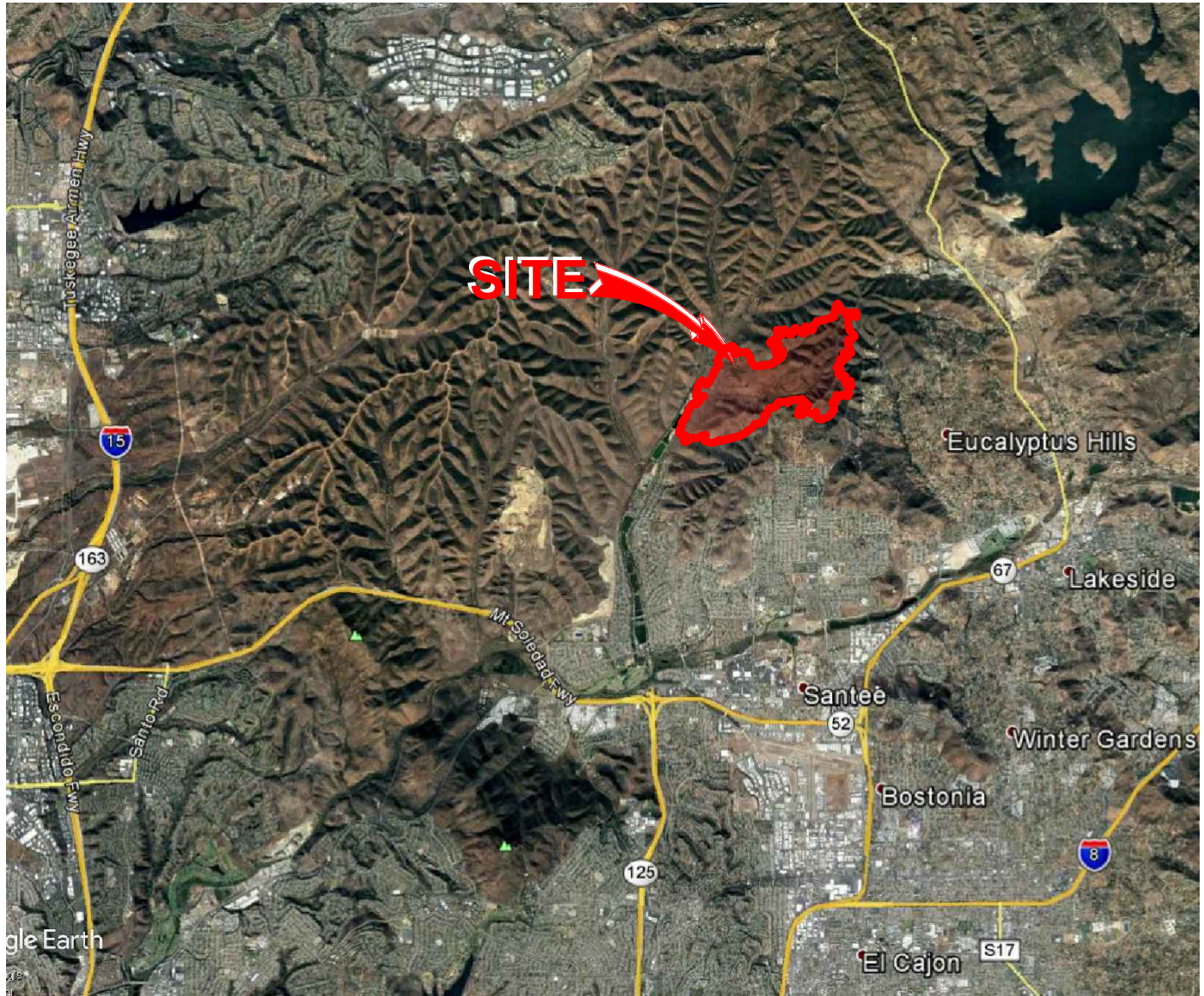

THE GEOGRAPHICAL INFORMATION MADE AVAILABLE FOR DISPLAY WAS PROVIDED BY GOOGLE EARTH, SUBJECT TO A LICENSING AGREEMENT. THE INFORMATION IS FOR ILLUSTRATIVE PURPOSES ONLY; IT IS NOT INTENDED FOR CLIENT'S USE OR RELIANCE AND SHALL NOT BE REPRODUCED BY CLIENT. CLIENT SHALL INDEMNIFY, DEFEND AND HOLD HARMLESS GEOCON FROM ANY LIABILITY INCURRED AS A RESULT OF SUCH USE OR RELIANCE BY CLIENT.



NO SCALE

VICINITY MAP

GEOCON
INCORPORATED



GEOTECHNICAL ■ ENVIRONMENTAL ■ MATERIALS
6960 FLANDERS DRIVE - SAN DIEGO, CALIFORNIA 92121 - 2974
PHONE 858 558-6900 - FAX 858 558-6159

FANITA RANCH
FANITA COMMONS, ORCHARD VILLAGE
AND VINEYARD VILLAGE
SANTEE, CALIFORNIA

DE / RA

DSK/GTPD

DATE 04 - 17 - 2020

PROJECT NO. 05254 - 32 - 18A

FIG. 1

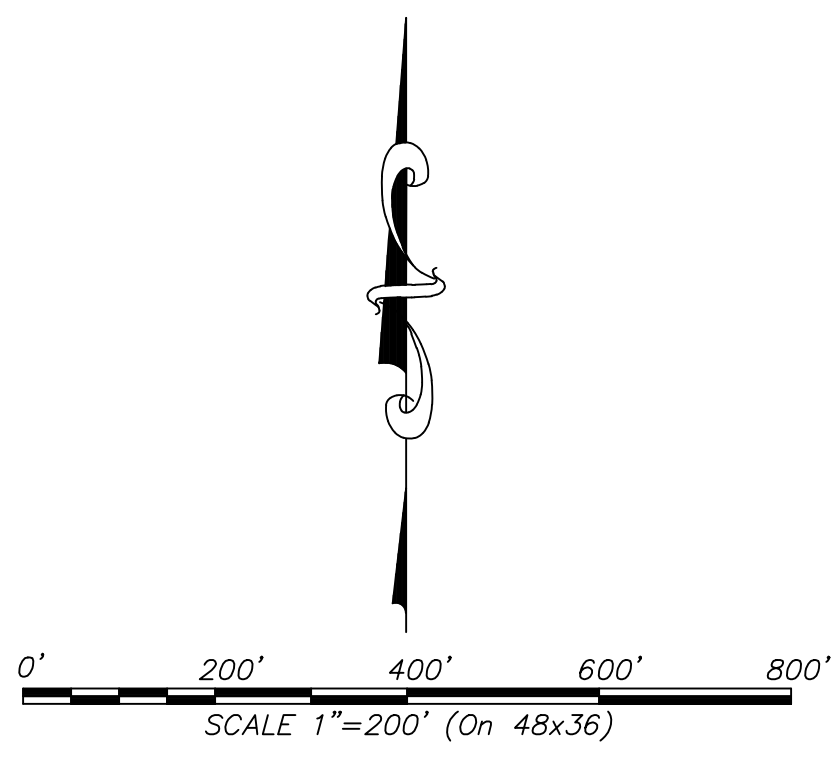
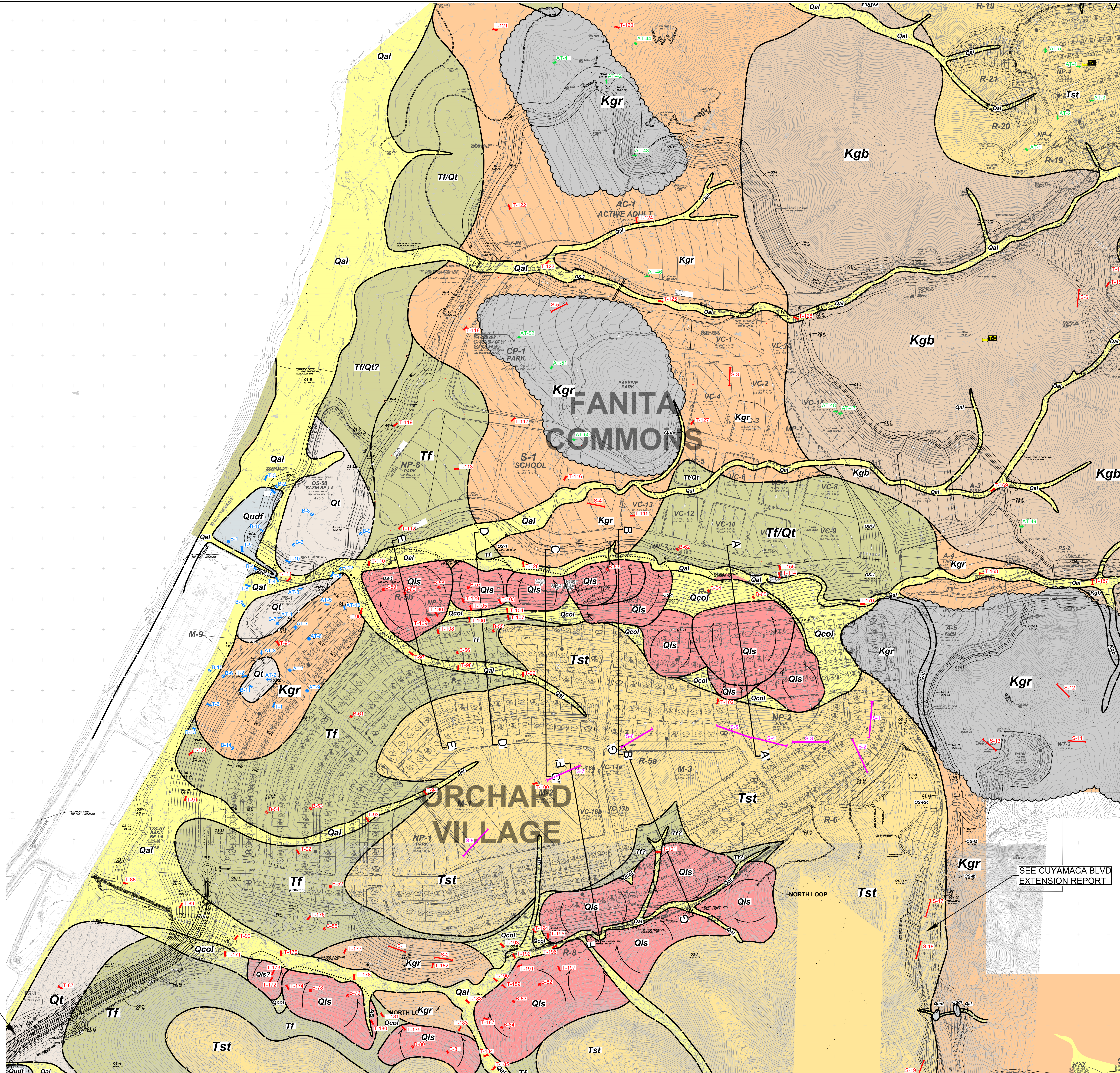

GEOCON LEGEND

Qudf	UNDOCUMENTED FILL
Qal	ALLUVIUM
Qcol	COLLUVIUM
Qal/Qdf	ALLUVIUM/DEBRIS FLOW
Qls	LANDSLIDE DEBRIS
Qt	TERRACE DEPOSIT
Tst	STADIUM CONGLOMERATE
Tf	FRANS FORMATION
Kgr/Kgb	GRANITIC ROCK
	APPROX. LOCATION OF GEOLOGIC CONTACT (Other than Basic, Quaternary Unconsolidated)
	APPROX. LOCATION OF EXPLORATORY BORING PERFORMED BY GEOCON 1997 (Appendix A)
	APPROX. LOCATION OF EXPLORATORY TRENCH PERFORMED BY GEOCON 1997 (Appendix A)
	APPROX. LOCATION OF EXPLORATORY BORING PERFORMED BY GEOCON 2005 (Appendix B)
	APPROX. LOCATION OF EXPLORATORY BORING PERFORMED BY GEOCON 2007 (Appendix C)
	APPROX. LOCATION OF AIR-TRACK BORING PERFORMED BY GEOCON 2007 (Appendix C)
	APPROX. LOCATION OF EXPLORATORY TRENCH PERFORMED BY GEOCON 2007 (Appendix C)
	APPROX. LOCATION OF EXPLORATORY TRENCH PERFORMED BY GEOCON 2007 (Appendix C)
	APPROX. LOCATION OF EXPLORATORY TRENCH PERFORMED BY GEOCON 2014 (Appendix E)
	CONCENTRATED ROCK OUTCROPPINGS

SEE FANITA PARKWAY WIDENING REPORT

SEE CUYAMACA BLVD EXTENSION REPORT

GEOLOGIC MAP
 FANITA RANCH
 FANITA COMMONS, ORCHARD VILLAGE
 AND VINEYARD VILLAGE
 SANTEE, CALIFORNIA

GEOCON 1200 G STREET, SUITE 100 SANTEE, CALIFORNIA 95068 PH: 925.858.0000 FAX: 925.858.0047	SCALE 1" = 200' DATE 04-17-2020
PROJECT NO. 05254-32-18A	FIGURE 2
SHEET 1 OF 1	

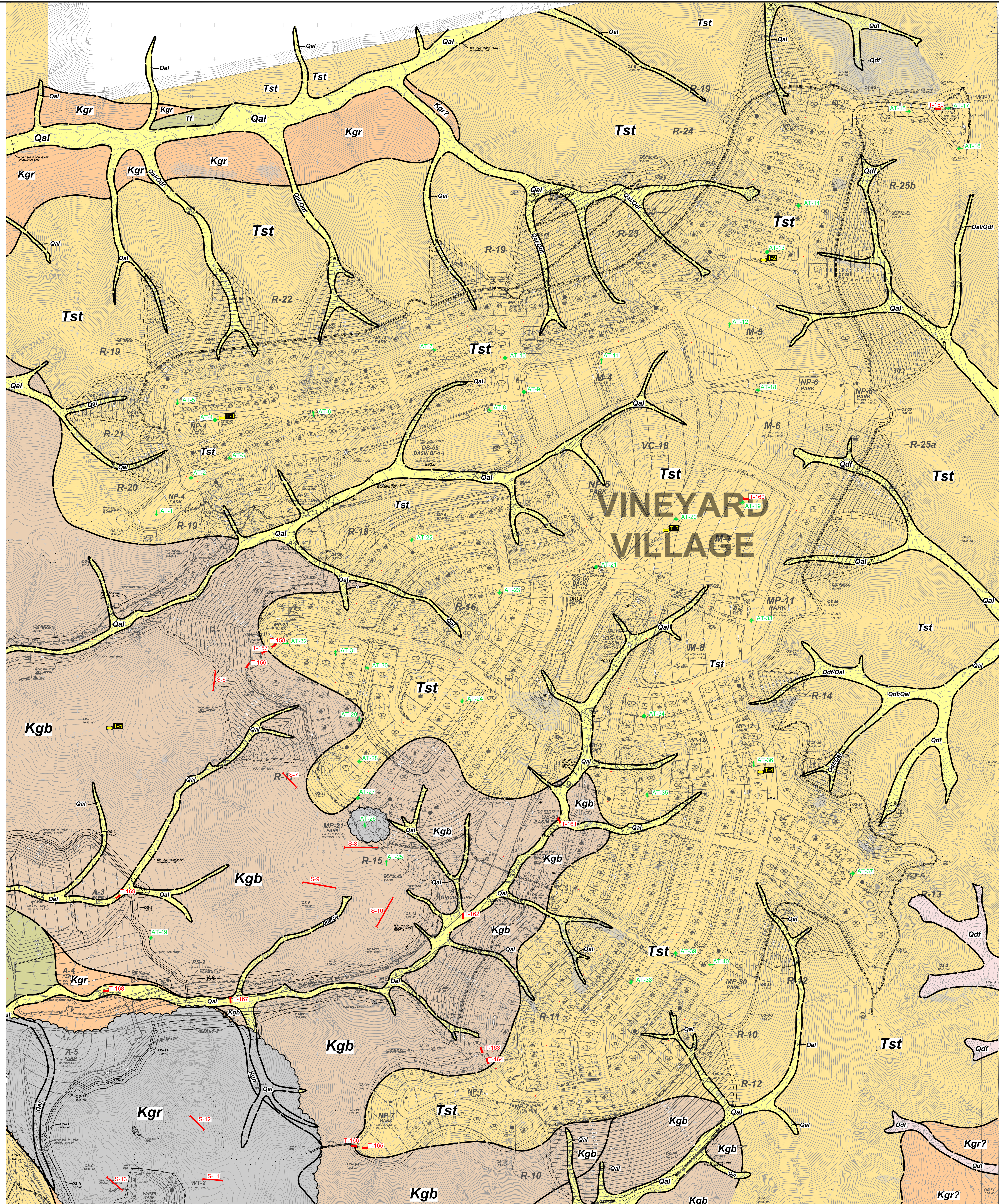

VINEYARD VILLAGE

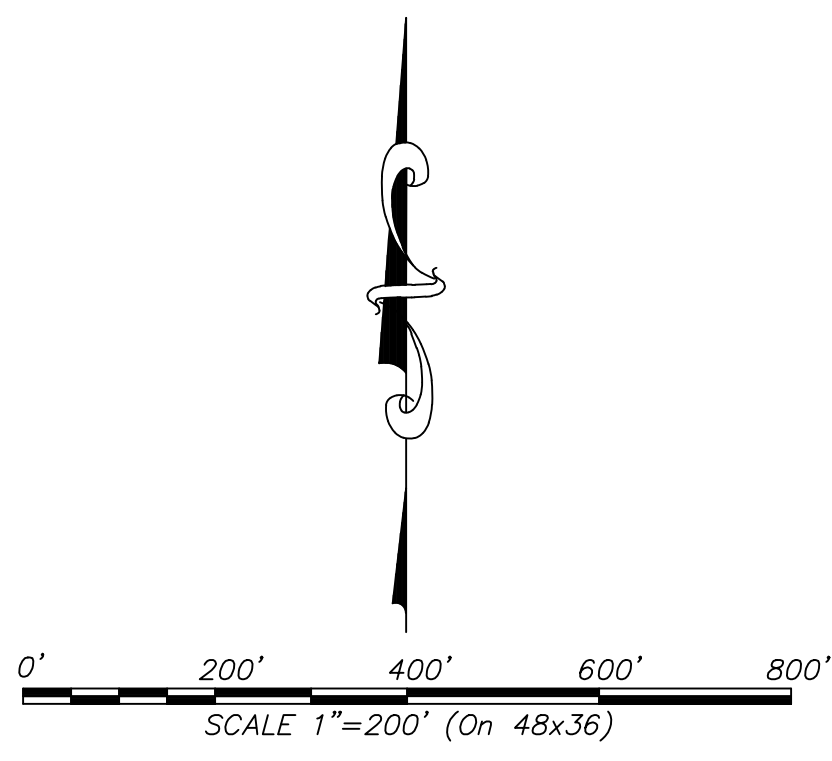

- GEOCON LEGEND**
- Qdof** UNDOCUMENTED FILL
 - Qal** ALLUVIUM
 - Qcol** COLLUVIUM
 - Qal/Qdf** ALLUVIUM/DEBRIS FLOW
 - Qls** LANDSLIDE DEBRIS
 - Qt** TERRACE DEPOSIT
 - Tst** STADIUM CONGLOMERATE
 - Tf** TERRACE FORMATION
 - Kgr/Kgb** GRANITIC ROCK
 - APPROX. LOCATION OF GEOLOGIC CONTACT (Other Than Basin, Quaternary Unconformity)
 - B-5** APPROX. LOCATION OF EXPLORATORY BORING PERFORMED BY GEOCON 1997 (Appendix A)
 - T-197** APPROX. LOCATION OF EXPLORATORY TRENCH PERFORMED BY GEOCON 1997 (Appendix A)
 - S-13** APPROX. LOCATION OF EXPLORATORY BORING PERFORMED BY GEOCON 1997 (Appendix B)
 - AT-52** APPROX. LOCATION OF EXPLORATORY BORING PERFORMED BY GEOCON 2005 (Appendix B)
 - B-15** APPROX. LOCATION OF EXPLORATORY BORING PERFORMED BY GEOCON 2007 (Appendix C)
 - AT-10** APPROX. LOCATION OF AIR-TRACK BORING PERFORMED BY GEOCON 2007 (Appendix C)
 - T-10** APPROX. LOCATION OF EXPLORATORY TRENCH PERFORMED BY GEOCON 2007 (Appendix C)
 - S-5** APPROX. LOCATION OF SEISMIC TRAVERSE PERFORMED BY GEOCON 2007 (Appendix D)
 - T-165** APPROX. LOCATION OF EXPLORATORY TRENCH PERFORMED BY GEOCON 2014 (Appendix E)
 - CONCENTRATED ROCK OUTCROPPINGS

GEOLOGIC MAP
 FANITA RANCH
 FANITA COMMONS, ORCHARD VILLAGE
 AND VINEYARD VILLAGE
 SANTEE, CALIFORNIA

GEOCON 1200 G STREET, SUITE 100 SAN DIEGO, CALIFORNIA 92101 PH: 619.584.0000 FAX: 619.584.0001		SCALE 1" = 200' DATE 04-17-2020
PROJECT NO. 05254 - 32 - 18A	SHEET 1 OF 2	FIGURE 3

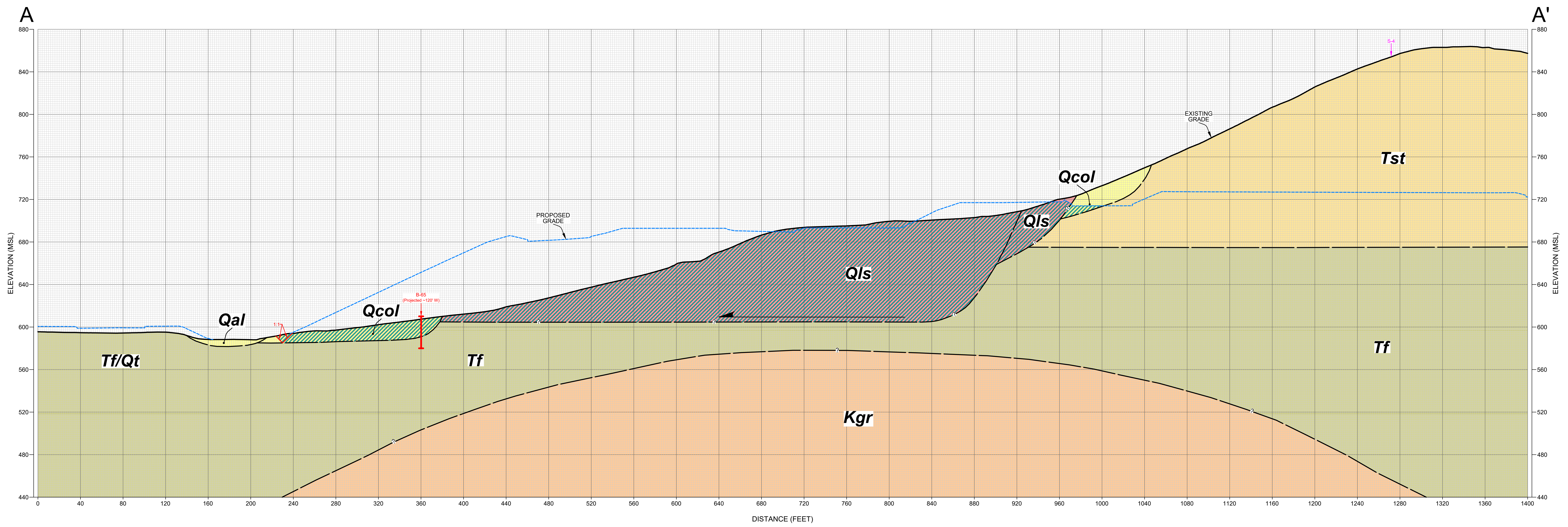

GEOLOGIC CROSS-SECTION A-A'
SCALE: 1" = 40' (Vert. = Horiz.)

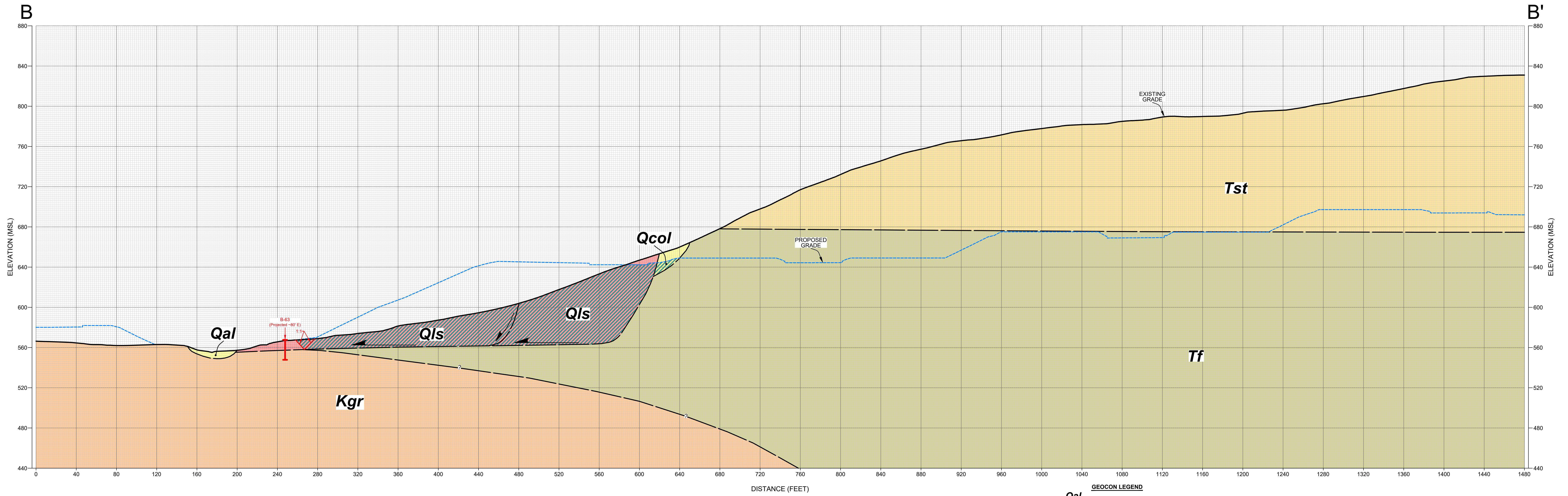

GEOLOGIC CROSS-SECTION B-B'
SCALE: 1" = 40' (Vert. = Horiz.)

- GEOCON LEGEND**
- Qal** ALLUVIUM
 - Qcol** COLLUVIUM
 - Qls** LANDSLIDE DEBRIS
 - Tst** STADIUM CONGLOMERATE
 - Tf** FRIARS FORMATION
 - Kgr** GRANITIC ROCK
 - B-51** APPROX. LOCATION OF EXPLORATORY BORING
 - B-55** APPROX. LOCATION OF SEISMIC TRAVERSE
 - APPROX. LOCATION OF GEOLOGIC CONTACT (Queried Where Uncertain)
 - ESTIMATED ZONE OF REMOVAL AND COMPACTION

GEOLOGIC CROSS - SECTIONS

FANITA RANCH
FANITA COMMONS, ORCHARD VILLAGE
AND VINEYARD VILLAGE
SANTEE, CALIFORNIA

GEOCON 11000 BIRCH BLVD. GEO TECHNICAL ■ ENVIRONMENTAL ■ MATERIALS 6900 FLANKERS DRIVE - SAN DIEGO, CALIFORNIA 92121-2974 PHONE: 619.598.6000 FAX: 619.598.6057		SCALE: 1" = 40'	DATE: 04 - 17 - 2020
PROJECT NO: 05254 - 32 - 18A	FIGURE: 4		
SHEET 1 OF 1			

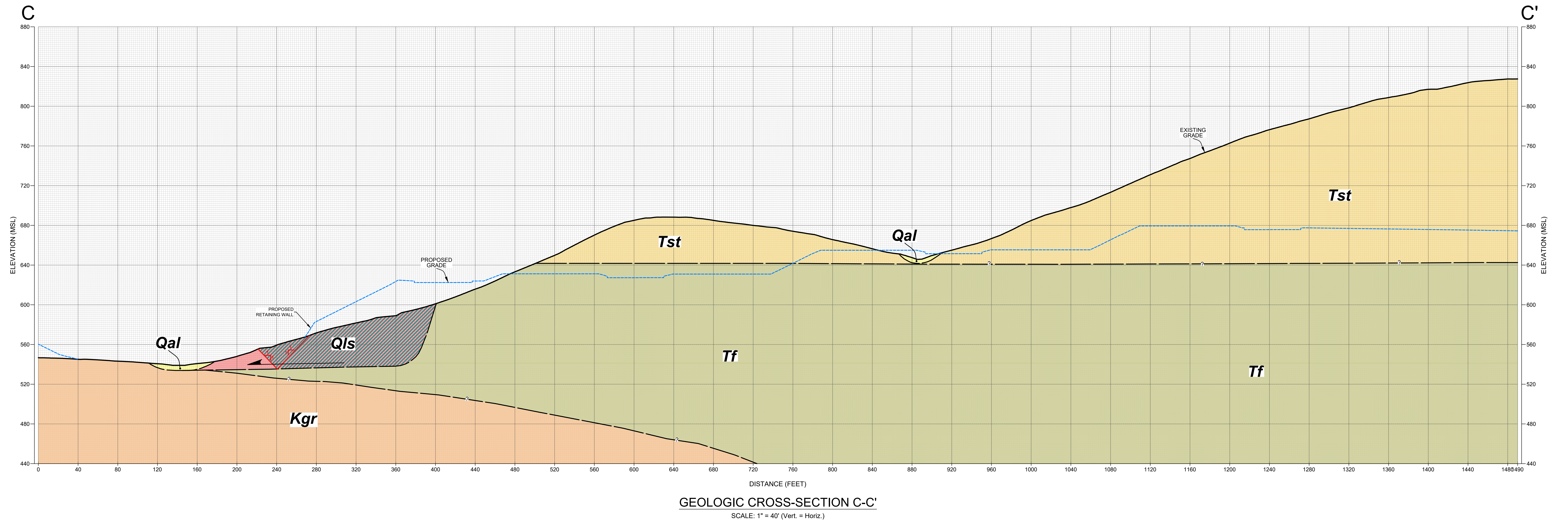

GEOLOGIC CROSS-SECTION C-C'
SCALE: 1" = 40' (Vert. = Horiz.)

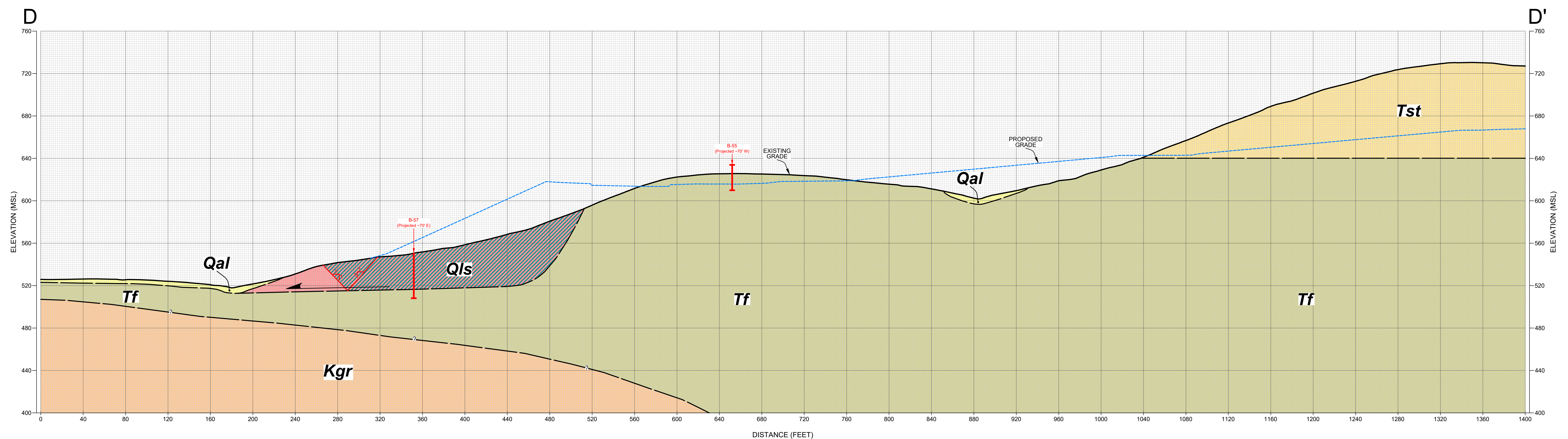

GEOLOGIC CROSS-SECTION D-D'
SCALE: 1" = 40' (Vert. = Horiz.)

- GEOCON LEGEND**
- Qal** ALLUVIUM
 - Qcol** COLLUVIUM
 - Qls** LANDSLIDE DEBRIS
 - Tst** STADIUM CONGLOMERATE
 - Tf** FRIARS FORMATION
 - Kgr** GRANITIC ROCK
 - B-57** APPROX. LOCATION OF EXPLORATORY BORING
 - B-55** APPROX. LOCATION OF SEISMIC TRAVERSE
 - APPROX. LOCATION OF GEOLOGIC CONTACT (Queried Where Uncertain)
 - ESTIMATED ZONE OF REMOVAL AND COMPACTION

GEOLOGIC CROSS - SECTIONS			
FANITA RANCH FANITA COMMONS, ORCHARD VILLAGE AND VINEYARD VILLAGE SANTEE, CALIFORNIA			
GEOCON INCORPORATED GEO-TECHNICAL ■ ENVIRONMENTAL ■ MATERIALS		SCALE 1" = 40'	DATE 04 - 17 - 2020
PROJECT NO. 05254 - 32 - 18A		FIGURE	5
SHEET 1 OF 1			

P:\05254\18020\3-24P1\1\SUBAREA\1\Final\GEO\GEOLOGIC CROSS-SECTION\GEOLOGIC CROSS-SECTION C-C'.DWG

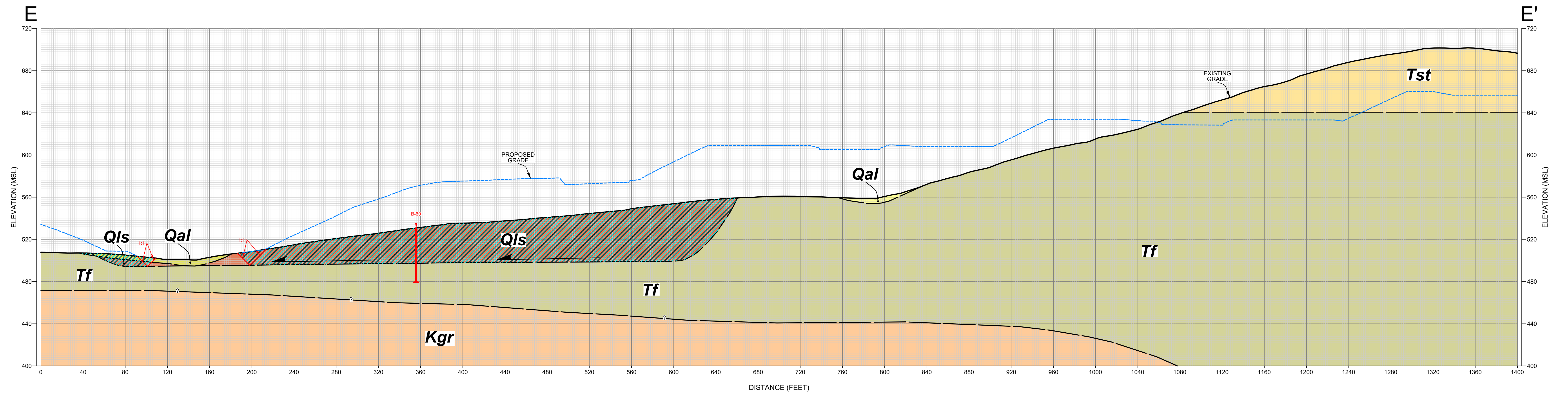

GEOLOGIC CROSS-SECTION E-E'
SCALE: 1" = 40' (Vert. = Horiz.)

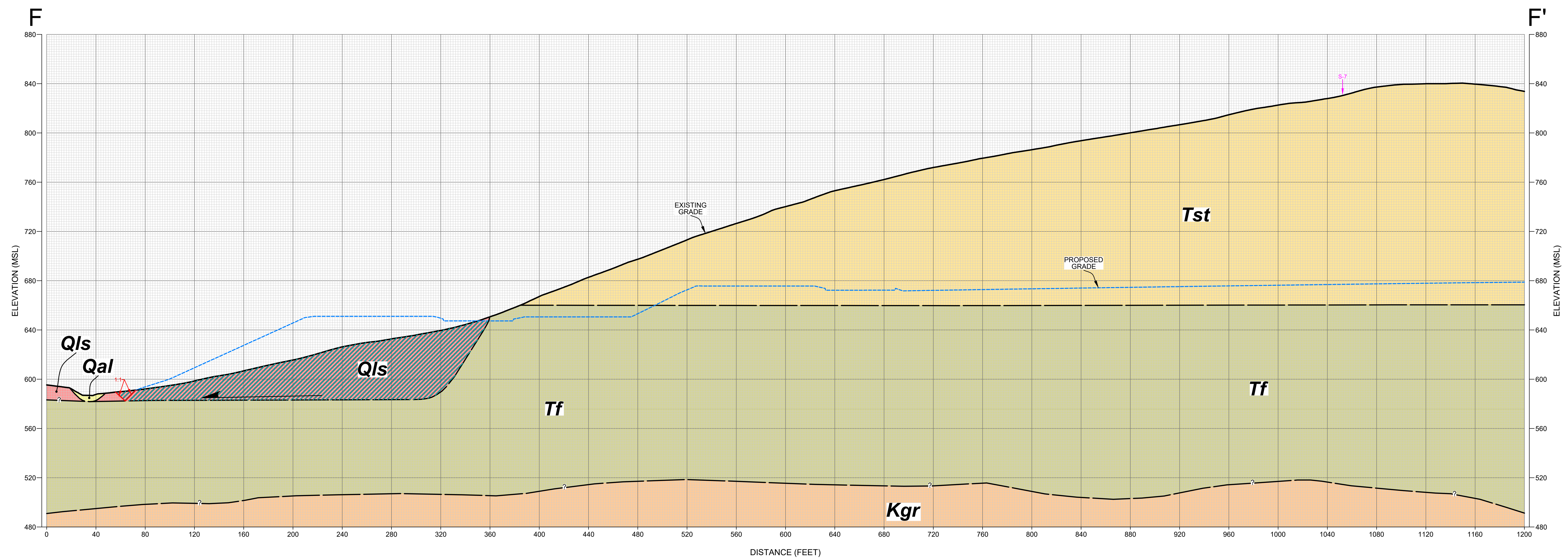

GEOLOGIC CROSS-SECTION F-F'
SCALE: 1" = 40' (Vert. = Horiz.)

- GEOCON LEGEND**
- Qal** ALLUVIUM
 - Qcol** COLLUVIUM
 - Qls** LANDSLIDE DEBRIS
 - Tst** STADIUM CONGLOMERATE
 - Tf** FRIARS FORMATION
 - Kgr** GRANITIC ROCK
 - B-01** APPROX. LOCATION OF EXPLORATORY BORING
 - S-T** APPROX. LOCATION OF SEISMIC TRAVERSE
 - APPROX. LOCATION OF GEOLOGIC CONTACT (Queried Where Uncertain)
 - ESTIMATED ZONE OF REMOVAL AND COMPACTION

GEOLOGIC CROSS - SECTIONS			
FANITA RANCH FANITA COMMONS, ORCHARD VILLAGE AND VINEYARD VILLAGE SANTEE, CALIFORNIA			
GEOCON 13000 BLOOMINGDALE BLVD. SAN DIEGO, CALIFORNIA 92121-2974 PHONE 619 588-6900 FAX 619 588-6997		SCALE 1" = 40'	DATE 04 - 17 - 2020
PROJECT NO. 06254 - 32 - 18A		FIGURE 6	
SHEET 1 OF 1		FIGURE 6	

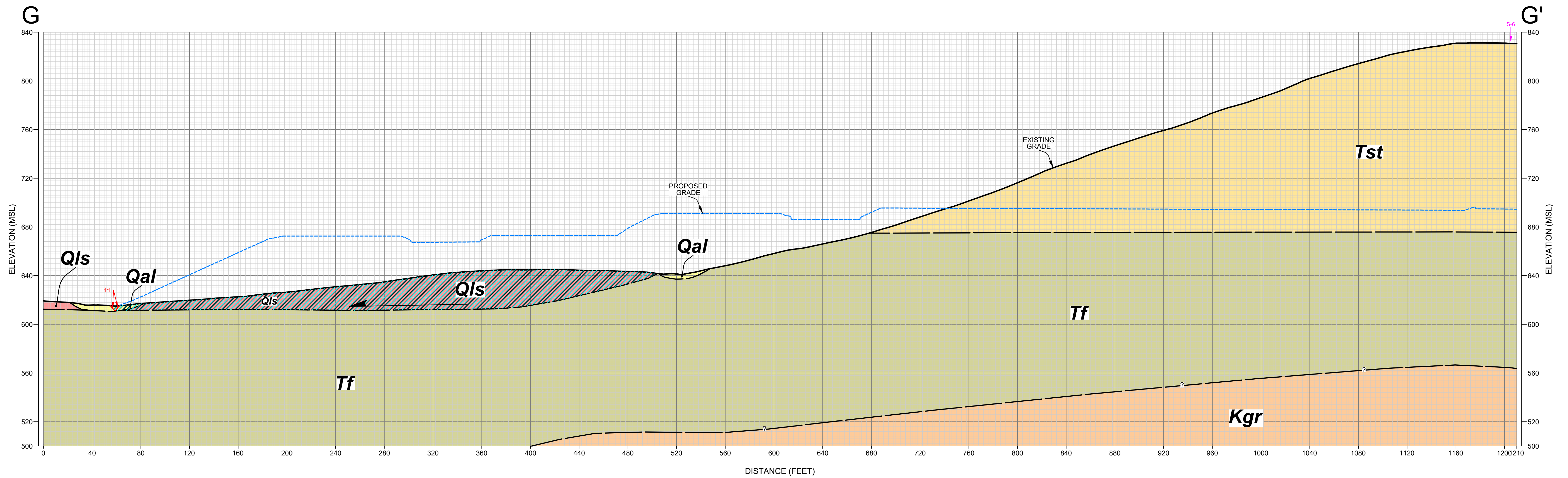

GEOLOGIC CROSS-SECTION G-G'
 SCALE: 1" = 40' (Vert. = Horiz.)

- GEOCON LEGEND**
- Qal** ALLUVIUM
 - Qcol** COLLUVIUM
 - Qls** LANDSLIDE DEBRIS
 - Tst** STADIUM CONGLOMERATE
 - Tf** FRIARS FORMATION
 - Kgr** GRANITIC ROCK
 - B-57** APPROX. LOCATION OF EXPLORATORY BORING
 - S-7** APPROX. LOCATION OF SEISMIC TRAVERSE
 - APPROX. LOCATION OF GEOLOGIC CONTACT (Queried Where Uncertain)
 - [Hatched Box] ESTIMATED ZONE OF REMOVAL AND COMPACTION

GEOLOGIC CROSS - SECTIONS		
FANITA RANCH FANITA COMMONS, ORCHARD VILLAGE AND VINEYARD VILLAGE SANTEE, CALIFORNIA		
GEOCON INCORPORATED	SCALE 1" = 40'	DATE 04 - 17 - 2020
GEO TECHNICAL ■ ENVIRONMENTAL ■ MATERIALS 6960 BLANDES DRIVE - SAN DIEGO, CALIFORNIA 92121 - 2974 PHONE 858.558.4900 - FAX 858.558.4159	PROJECT NO. 05254 - 32 - 18A	FIGURE 7
SHEET 1 OF 1		

Plotfile:04172020_330PM | By: RUBEN AGUIAR | File Location: Y:\PROJECTS\05254-32-18A\Fanita Ranch-Materials\Figures\SECTION\05254-32-18A_Plotfile-Materials.dwg

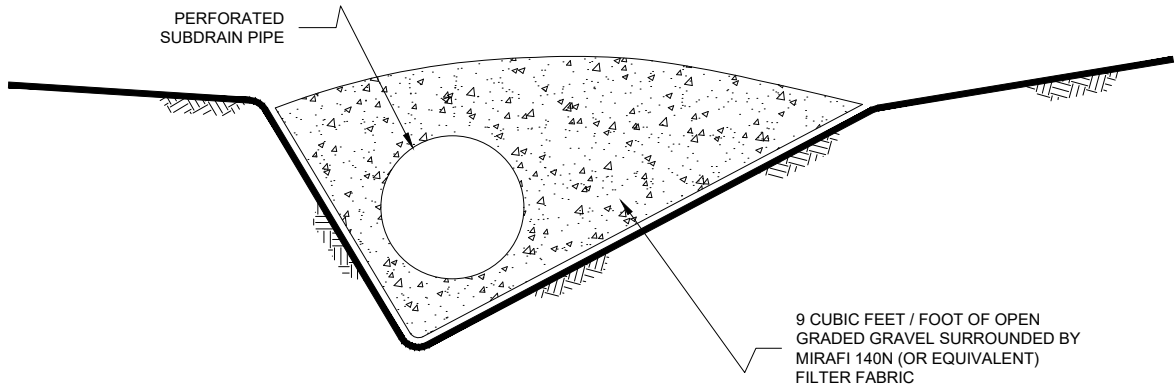
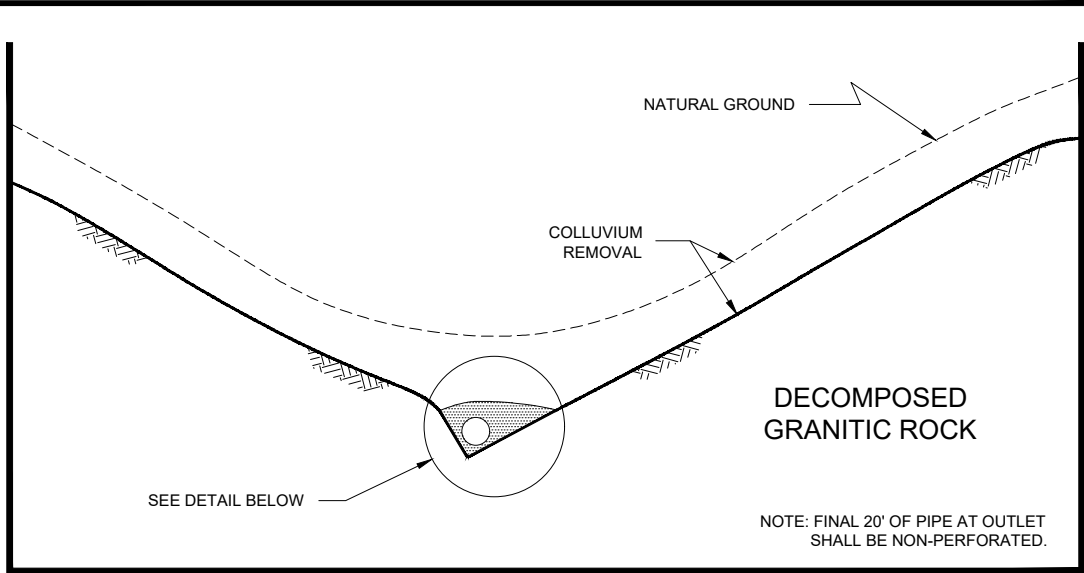

NOTES:

- 1.....6-INCH DIAMETER, SCHEDULE 80 PVC PERFORATED PIPE FOR FILLS IN EXCESS OF 100-FEET IN DEPTH.
- 2.....6-INCH DIAMETER, SCHEDULE 40 PVC PERFORATED PIPE FOR FILLS LESS THAN 100-FEET IN DEPTH.

NO SCALE

TYPICAL CANYON SUBDRAIN DETAIL

GEOCON
INCORPORATED



GEOTECHNICAL ■ ENVIRONMENTAL ■ MATERIALS
6960 FLANDERS DRIVE - SAN DIEGO, CALIFORNIA 92121 - 2974
PHONE 858 558-6900 - FAX 858 558-6159

FANITA RANCH
FANITA COMMONS, ORCHARD VILLAGE
AND VINEYARD VILLAGE
SANTEE, CALIFORNIA

DE / RA

DSK/GTYPD

DATE 04 - 17 - 2020

PROJECT NO. 05254 - 32 - 18A

FIG. 8

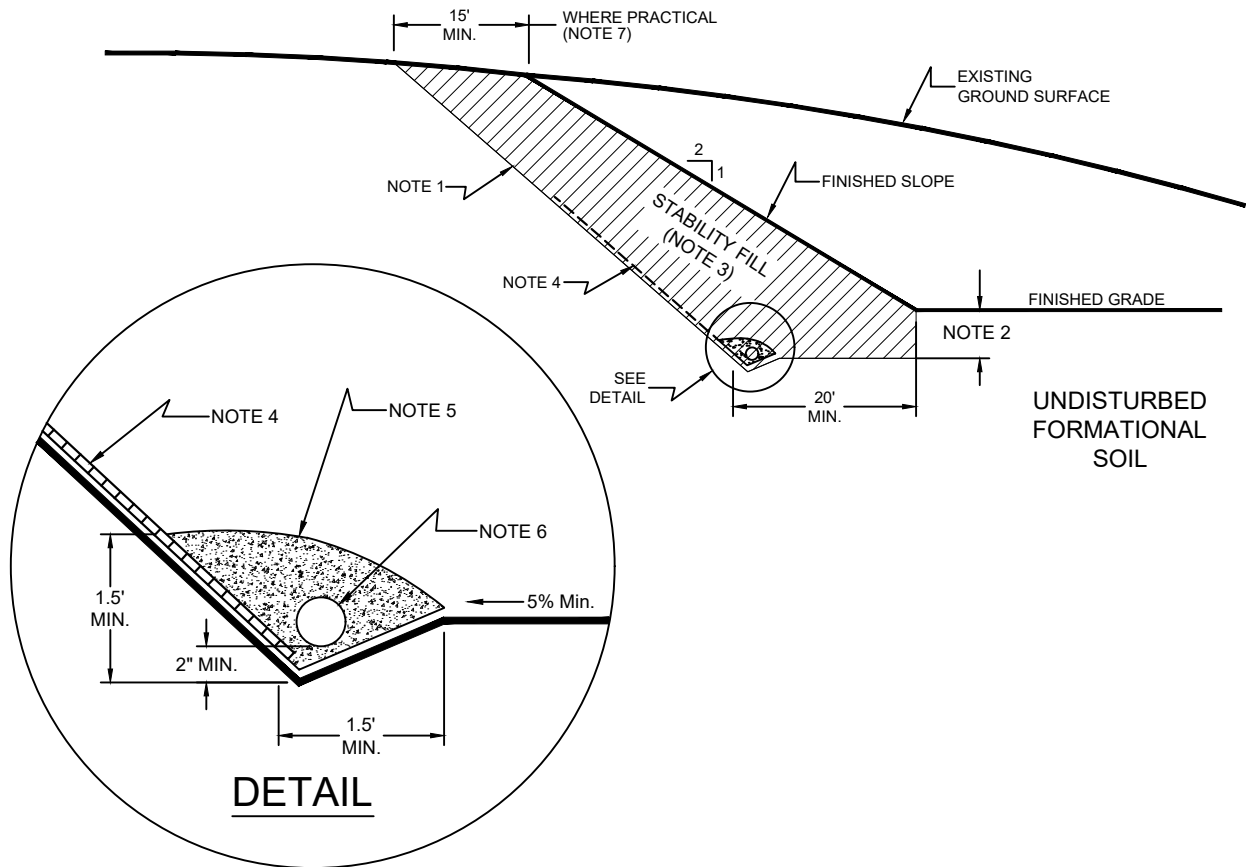

NOTES:

- 1.....EXCAVATE BACKCUT IN ACCORDANCE WITH GEOTECHNICAL CONSULTANTS RECOMMENDATION.
- 2.....BASE OF STABILITY FILL TO BE 3 FEET INTO DENSE, FORMATIONAL SOILS SLOPING A MINIMUM 5% INTO SLOPE.
- 3.....STABILITY FILL TO BE COMPOSED OF PROPERLY COMPACTED, GRANULAR SOIL AS SPECIFIED.
- 4.....CHIMNEY DRAINS TO BE APPROVED, PREFABRICATED CHIMNEY DRAIN PANELS (MIRADRAIN, TENSAR, OR EQUIVALENT) SPACED APPROXIMATELY 30 FEET CENTER TO CENTER. ADDITIONAL DRAINS WILL BE REQUIRED WHERE AREAS OF SEEPAGE ARE ENCOUNTERED.
- 5.....FILTER MATERIAL TO BE 3/4-INCH, OPEN-GRADED, CRUSHED ROCK ENCLOSED IN APPROVED FILTER FABRIC .
- 6.....COLLECTOR PIPE TO BE 4-INCH MINIMUM DIAMETER, PERFORATED, THICK-WALLED PVC SCHEDULE 40 OR EQUIVALENT, AND SLOPED TO DRAIN AT 1 PERCENT MINIMUM TO APPROVED OUTLET.
- 7.....IF HORIZONTAL, EXTENT OF GRADING IS CONSTRAINED (e.g., THE PRESENCE OF A PROPERTY LINE), THE SLOPE SHOULD BE OVERBUILT, AT LEAST 4 FEET, AND TRIMMED BACK.

NO SCALE

TYPICAL STABILITY FILL DETAIL

GEOCON
INCORPORATED



GEOTECHNICAL ■ ENVIRONMENTAL ■ MATERIALS
6960 FLANDERS DRIVE - SAN DIEGO, CALIFORNIA 92121 - 2974
PHONE 858 558-6900 - FAX 858 558-6159

FANITA RANCH
FANITA COMMONS, ORCHARD VILLAGE
AND VINEYARD VILLAGE
SANTEE, CALIFORNIA

DE / RA

DSK/GTYPD

DATE 04 - 17 - 2020

PROJECT NO. 05254 - 32 - 18A

FIG. 9

ASSUMED CONDITIONS :

SLOPE HEIGHT	H = Infinite
DEPTH OF SATURATION	Z = 3 feet
SLOPE INCLINATION	2 : 1 (Horizontal : Vertical)
SLOPE ANGLE	i = 26.6 degrees
UNIT WEIGHT OF WATER	γ_w = 62.4 pounds per cubic foot
TOTAL UNIT WEIGHT OF SOIL	γ_t = 130 pounds per cubic foot
ANGLE OF INTERNAL FRICTION	ϕ = 30 degrees
APPARENT COHESION	C = 150 pounds per square foot

SLOPE SATURATED TO VERTICAL DEPTH Z BELOW SLOPE FACE

SEEPAGE FORCES PARALLEL TO SLOPE FACE

ANALYSIS :

$$FS = \frac{C + (\gamma_t - \gamma_w) Z \cos^2 i \tan \phi}{\gamma_t Z \sin i \cos i} = 1.56$$

REFERENCES :

- 1.....Haefeli, R. *The Stability of Slopes Acted Upon by Parallel Seepage*, Proc. Second International Conference, SMFE, Rotterdam, 1948, 1, 57-62
- 2.....Skempton, A. W., and F.A. Delory, *Stability of Natural Slopes in London Clay*, Proc. Fourth International Conference, SMFE, London, 1957, 2, 378-81

SURFICIAL SLOPE STABILITY ANALYSIS

GEOCON
INCORPORATED



GEOTECHNICAL ■ ENVIRONMENTAL ■ MATERIALS
6960 FLANDERS DRIVE - SAN DIEGO, CALIFORNIA 92121 - 2974
PHONE 858 558-6900 - FAX 858 558-6159

FANITA RANCH
FANITA COMMONS, ORCHARD VILLAGE
AND VINEYARD VILLAGE
SANTEE, CALIFORNIA

DE / RA

DSK/GTYPD

DATE 04 - 17 - 2020

PROJECT NO. 05254 - 32 - 18A

FIG. 10

ASSUMED CONDITIONS :

SLOPE HEIGHT H = 275 feet
SLOPE INCLINATION 2 : 1 (Horizontal : Vertical)
TOTAL UNIT WEIGHT OF SOIL γ_t = 130 pounds per cubic foot
ANGLE OF INTERNAL FRICTION ϕ = 35 degrees
APPARENT COHESION C = 300 pounds per square foot
NO SEEPAGE FORCES

ANALYSIS :

$$\gamma_{c\phi} = \frac{\gamma_t H \tan \phi}{C} \quad \text{EQUATION (3-3), REFERENCE 1}$$
$$FS = \frac{N_{cf} C}{\gamma_t H} \quad \text{EQUATION (3-2), REFERENCE 1}$$

$\gamma_{c\phi} = 83$ CALCULATED USING EQ. (3-3)
 $N_{cf} = 180$ DETERMINED USING FIGURE 10, REFERENCE 2
 $FS = 1.51$ FACTOR OF SAFETY CALCULATED USING EQ. (3-2)

REFERENCES :

- 1.....Janbu, N., Stability Analysis of Slopes with Dimensionless Parameters, Harvard Soil Mechanics, Series No. 46, 1954
- 2.....Janbu, N., Discussion of J.M. Bell, Dimensionless Parameters for Homogeneous Earth Slopes, Journal of Soil Mechanics and Foundation Design, No. SM6, November 1967.

SLOPE STABILITY ANALYSIS - FILL SLOPES

GEOCON
INCORPORATED



GEOTECHNICAL ■ ENVIRONMENTAL ■ MATERIALS
6960 FLANDERS DRIVE - SAN DIEGO, CALIFORNIA 92121 - 2974
PHONE 858 558-6900 - FAX 858 558-6159

FANITA RANCH
FANITA COMMONS, ORCHARD VILLAGE
AND VINEYARD VILLAGE
SANTEE, CALIFORNIA

DE / RA

DSK/GTYPD

DATE 04 - 17 - 2020

PROJECT NO. 05254 - 32 - 18A

FIG. 11

ASSUMED CONDITIONS :

SLOPE HEIGHT	H = 110 feet
SLOPE INCLINATION	2 : 1 (Horizontal : Vertical)
TOTAL UNIT WEIGHT OF SOIL	$\gamma_t = 130$ pounds per cubic foot
ANGLE OF INTERNAL FRICTION	$\phi = 33$ degrees
APPARENT COHESION	C = 500 pounds per square foot
NO SEEPAGE FORCES	

ANALYSIS :

$\gamma_{c\phi} = \frac{\gamma_t H \tan \phi}{C}$	EQUATION (3-3), REFERENCE 1
FS = $\frac{NcfC}{\gamma_t H}$	EQUATION (3-2), REFERENCE 1
$\gamma_{c\phi} = 18.6$	CALCULATED USING EQ. (3-3)
Ncf = 50	DETERMINED USING FIGURE 10, REFERENCE 2
FS = 1.75	FACTOR OF SAFETY CALCULATED USING EQ. (3-2)

REFERENCES :

- 1.....Janbu, N., Stability Analysis of Slopes with Dimensionless Parameters, Harvard Soil Mechanics, Series No. 46, 1954
- 2.....Janbu, N., Discussion of J.M. Bell, Dimensionless Parameters for Homogeneous Earth Slopes, Journal of Soil Mechanics and Foundation Design, No. SM6, November 1967.

SLOPE STABILITY ANALYSIS - CUT SLOPES

GEOCON
INCORPORATED



GEOTECHNICAL ■ ENVIRONMENTAL ■ MATERIALS
6960 FLANDERS DRIVE - SAN DIEGO, CALIFORNIA 92121 - 2974
PHONE 858 558-6900 - FAX 858 558-6159

FANITA RANCH
FANITA COMMONS, ORCHARD VILLAGE
AND VINEYARD VILLAGE
SANTEE, CALIFORNIA

DE / RA

DSK/GTYPD

DATE 04 - 17 - 2020

PROJECT NO. 05254 - 32 - 18A

FIG. 12

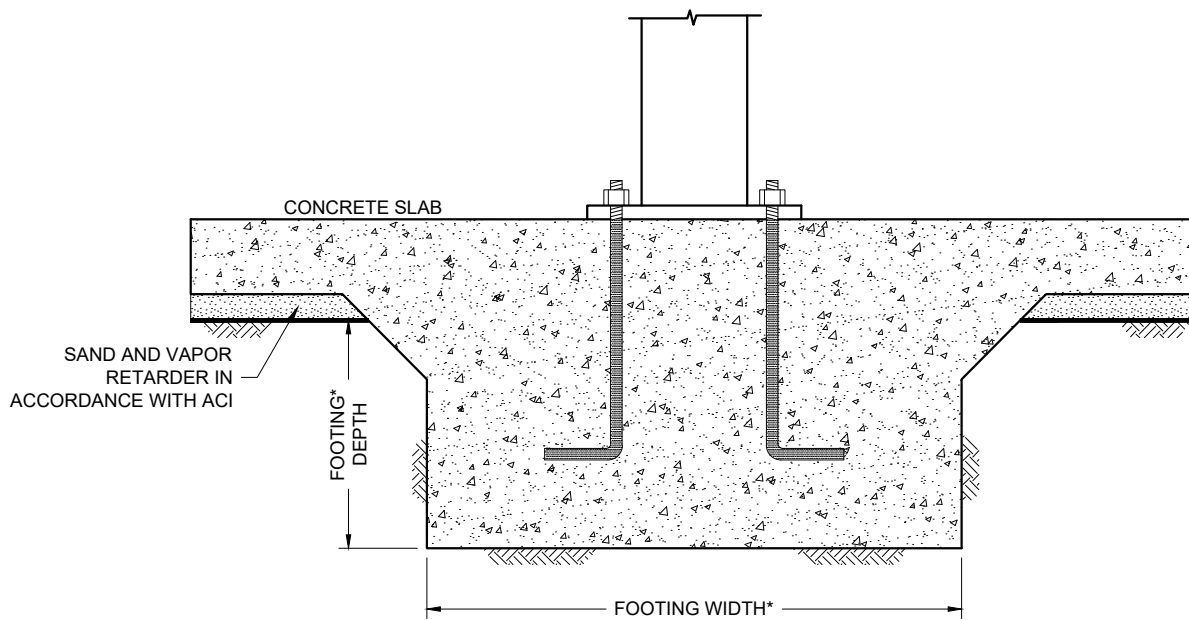
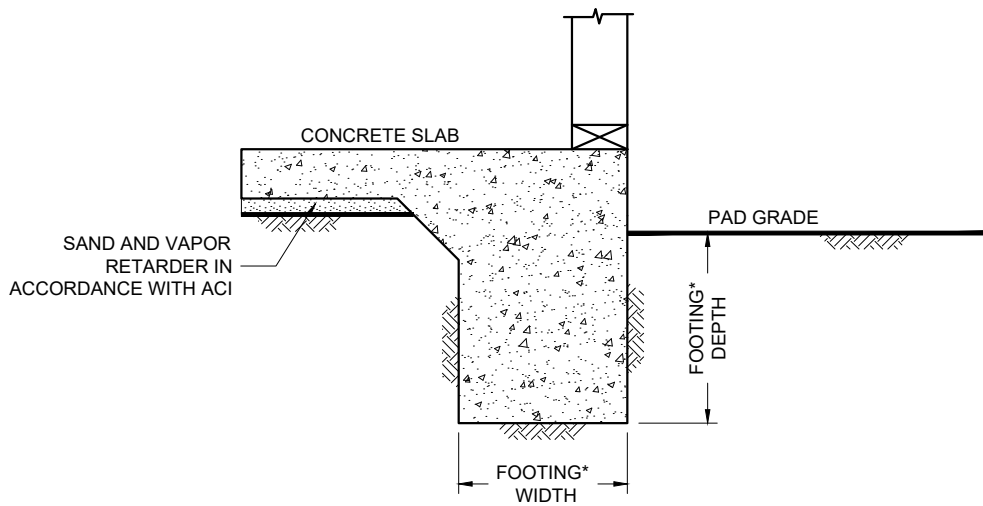

* ...SEE REPORT FOR FOUNDATION WIDTH AND DEPTH RECOMMENDATION

NO SCALE

WALL / COLUMN FOOTING DIMENSION DETAIL

GEOCON
INCORPORATED



GEOTECHNICAL ■ ENVIRONMENTAL ■ MATERIALS
6960 FLANDERS DRIVE - SAN DIEGO, CALIFORNIA 92121 - 2974
PHONE 858 558-6900 - FAX 858 558-6159

FANITA RANCH
FANITA COMMONS, ORCHARD VILLAGE
AND VINEYARD VILLAGE
SANTEE, CALIFORNIA

DE / RA

DSK/GTYPD

DATE 04 - 17 - 2020

PROJECT NO. 05254 - 32 - 18A

FIG. 13

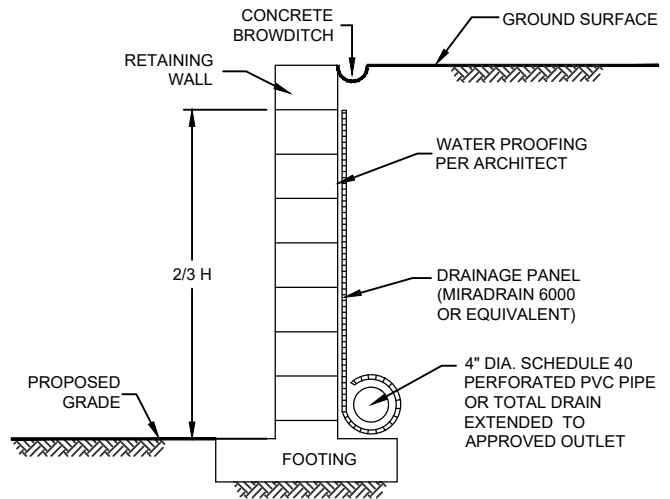
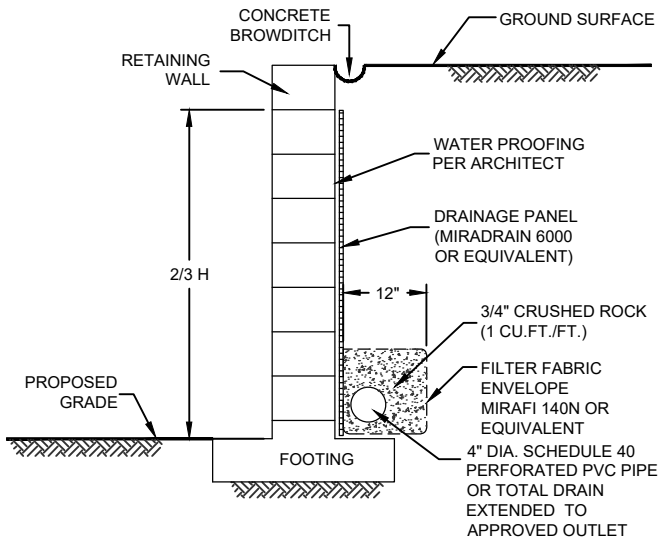
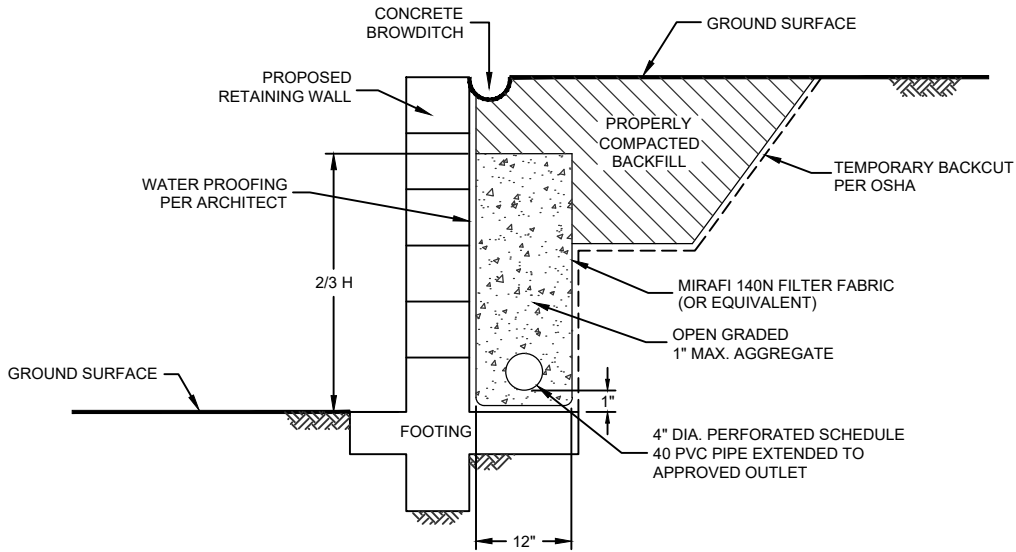

NOTE :

DRAIN SHOULD BE UNIFORMLY SLOPED TO GRAVITY OUTLET OR TO A SUMP WHERE WATER CAN BE REMOVED BY PUMPING

NO SCALE

TYPICAL RETAINING WALL DRAIN DETAIL

GEOCON
INCORPORATED



GEOTECHNICAL ■ ENVIRONMENTAL ■ MATERIALS
6960 FLANDERS DRIVE - SAN DIEGO, CALIFORNIA 92121 - 297 4
PHONE 858 558-6900 - FAX 858 558-6159

FANITA RANCH
FANITA COMMONS, ORCHARD VILLAGE
AND VINEYARD VILLAGE
SANTEE, CALIFORNIA

DE / RA

DSK/GTYPD

DATE 04 - 17 - 2020

PROJECT NO. 05254 - 32 - 18A

FIG. 14

APPENDIX

A

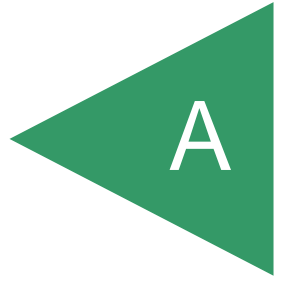

APPENDIX A

BORING, TRENCH, AND SEISMIC LOGS (1997)

FOR

**FANITA RANCH
FANITA COMMONS, ORCHARD VILLAGE AND VINEYARD VILLAGE
SANTEE, CALIFORNIA**

PROJECT NO. 05254-32-18A

APPENDIX A

FIELD INVESTIGATION

The field investigation for this phase of study was performed intermittently between April and July 1995 (reported in 1997), and consisted of a visual site reconnaissance, the excavation of 34 large-diameter borings, 111 backhoe trenches, and performing 13 seismic refraction traverses.

The large-diameter borings were advanced to a depth of 2 to 51 feet below existing grade using an Easy Bore 120 truck-mounted drill rig equipped with a 30-inch-diameter bucket auger. Relatively undisturbed samples were obtained by driving a 3-inch, split-tube sampler 12 inches into the undisturbed soil mass with blows from a telescoping Kelly bar varying in weight from 1800 to 4500 pounds. The sampler was equipped with six 1-inch-by-2.5-inch brass sampler rings to facilitate removal and testing. Bulk samples were also obtained.

The backhoe trenches were advanced to depths of 3 to 17 feet using a JD 555 extend-a-hoe equipped with a 24-inch-wide bucket. The soils encountered in the borings and backhoe trenches were visually examined, classified, and logged. Logs of the borings and backhoe trenches are presented on Figures A-1 through A-102. The logs depict the soil and geologic conditions encountered and the depth at which samples were obtained.

The seismic traverses were performed with an EG&G Geometrics 1225-model, 12-channel seismograph unit. The traverses were 100 feet long and were performed in both a forward and reverse direction. The results of each seismic traverse are summarized on Table A-I. Table A-II presents our interpretation of ripplable thickness of the rock based on the data obtained.

**TABLE A-I
SEISMIC TRAVERSES**

Seismic Traverse No.	Average Velocity (ft/sec)			Average Depth (ft)			Length of Traverse (ft)	Approximate Maximum Depth Explored (ft)
	V ₁	V ₂	V ₃	D ₁	D ₂	D ₃		
S-1	1400	3500	6500	7	12	>30	100	30
S-2	2100	4600	7200	6	19	>30	100	30
S-3	1300	2100	5800	5	18	>30	100	30
S-4	1500	2300	4000	2	12	>30	100	30
S-5	1600	3400	5800	6	23	>30	100	30
S-6	1600	3000	6100	8	23	>30	100	30
S-7	1600	4700	9600	7	20	>30	100	30
S-8	1300	3200	11000	8	23	>30	200	60
S-9	2800	14000	---	8	>60	---	200	60
S-10	1600	3700	6300	6	30	>60	200	60
S-11	1800	5600	---	4	>30	-	100	30
S-12	3000	6000	---	8	33	-	100	30
S-13	1700	5000	9400	3	11	>30	100	30

V₁ = Velocity in feet per second of first layer of materials

V₂ = Second layer velocities

V₃ = Third layer velocities

D₁ = Depth in feet to base of first layer

D₂ = Depth to base of second layer

D₃ = Depth to base of third layer

NOTE:

For mass grading, materials with velocities of less than 4500 fps are generally rippable with a D9 Caterpillar Tractor equipped with a single shank hydraulic ripper. Velocities of 4500 to 5500 fps indicate marginal ripping and blasting. Velocities greater than 5500 fps generally require pre-blasting. For trenching, materials with velocities less than 3800 fps are generally rippable depending upon the degree of fracturing and the presence or absence of boulders. Velocities between 3800 and 4300 fps generally indicate marginal ripping, and velocities greater than 4300 fps generally indicate non-rippable conditions. The above velocities are based on a Kohring 505.

The reported velocities represent average velocities over the length of each traverse, and should not generally be used for subsurface interpretation greater than 100 feet from a traverse.

**TABLE A-II
APPROXIMATE THICKNESS OF RIPPABLE ROCK**

Traverse No.	Approximate Thickness (ft)*
S-1	12
S-2	19 (marginally rippable at 6 feet)
S-3	18
S-4	>30**
S-5	23
S-6	23
S-7	20**
S-8	41***
S-9	8
S-10	30***
S-11	4
S-12	8
S-13	11 (marginally rippable at 3 feet)

*Assumes D9 Caterpillar tractor.

**Possible erratic data.

***Possible erratic data, see text.

DEPTH IN FEET	SAMPLE NO.	LITHOLOGY	GROUNDWATER	SOIL CLASS (USCS)	BORING B 52		PENETRATION RESISTANCE (BLOWS/FT.)	DRY DENSITY (P.C.F.)	MOISTURE CONTENT (%)
					ELEV. (MSL.) 600	DATE COMPLETED 4/5/95			
					EQUIPMENT E-120				
MATERIAL DESCRIPTION									
0				SM/GM	TOPSOIL Loose, moist, light orangish brown, Silty, fine to medium SAND with abundant cobbles				
2									
4				GM	FRIARS FORMATION Dense, damp, light brown, Silty, fine to medium Sandy GRAVEL/COBBLE CONGLOMERATE; moderately cemented, predominant clast size 2 inch to 4 inch with boulders up to 14 inch diameter, orange oxide staining				
6									
8									
10									
12									
14									
16				SM	-Sharp, near-horizontal contact at 15 feet Dense, damp, light grey, Silty, fine SANDSTONE; massive and micaceous, scattered gravels				
18									
20	B52-1				-Gravelly, highly cemented, concretionary lense with angular rip-up clasts from 17.4 feet to 19 feet, continuous around boring, underlain by 2 inch to 12 inch irregular-shaped lense of red to dark brown with orange mottling clayey sand with gravel		6	119.1	14.3
22					-Grades back and forth from silty, fine sandstone to fine sandy siltstone below 19 feet, very difficult drilling; 4 hours to drill 35 feet				
24									
26				GM	-Irregular, generally horizontal contact at 25.4 feet Very dense, damp, light grey to white, Sandy GRAVEL/COBBLE CONGLOMERATE; matrix highly and completely cemented, predominant clast size 2 inch to 4 inch with clasts up to 12-inch-diameter				
28									
30									
32									
34									
					REFUSAL AT 35 FEET				

Figure A-1 Log of Boring B 52, page 1 of 1

FRNC1

SAMPLE SYMBOLS	<input type="checkbox"/>	... SAMPLING UNSUCCESSFUL	<input type="checkbox"/>	... STANDARD PENETRATION TEST	<input checked="" type="checkbox"/>	... DRIVE SAMPLE (UNDISTURBED)
	<input checked="" type="checkbox"/>	... DISTURBED OR BAG SAMPLE	<input checked="" type="checkbox"/>	... CHUNK SAMPLE	<input checked="" type="checkbox"/>	... WATER TABLE OR SEEPAGE

NOTE: THE LOG OF SUBSURFACE CONDITIONS SHOWN HEREON APPLIES ONLY AT THE SPECIFIC BORING OR TRENCH LOCATION AND AT THE DATE INDICATED. IT IS NOT WARRANTED TO BE REPRESENTATIVE OF SUBSURFACE CONDITIONS AT OTHER LOCATIONS AND TIMES.

DEPTH IN FEET	SAMPLE NO.	LITHOLOGY	GROUNDWATER	BORING B 53		PENETRATION RESISTANCE (BLOWS/FT.)	DRY DENSITY (P.C.F.)	MOISTURE CONTENT (%)
				SOIL CLASS (USCS)	ELEV. (MSL.) <u>557</u> DATE COMPLETED <u>4/6/95</u> EQUIPMENT <u>E-120</u>			
MATERIAL DESCRIPTION								
0				SM	TOPSOIL Loose, damp, medium to light brown, Silty, fine SAND			
2				CL/GC	Stiff, moist, orange-brown, fine to medium Sandy CLAY, with gravel/cobbles			
4				GM	FRIARS FORMATION Very dense, damp, orange-brown, Silty, fine to medium Sandy GRAVEL/COBBLE CONGLOMERATE; moderately to highly cemented, matrix supported, predominant clast size 2 inch to 4 inch with clasts up to 10-inch-diameter			
6								
8								
10								
12					-Lense of very dense, damp, light brown to orange-brown, silty, fine sandstone from 10.6 to 12.5 feet			
14					-Very difficult drilling, 1.5 hours to advance 10 feet			
PRACTICAL REFUSAL AT 15 FEET								

Figure A-2 Log of Boring B 53, page 1 of 1

FRNC1

SAMPLE SYMBOLS	<input type="checkbox"/> ... SAMPLING UNSUCCESSFUL	<input type="checkbox"/> ... STANDARD PENETRATION TEST	<input checked="" type="checkbox"/> ... DRIVE SAMPLE (UNDISTURBED)
	<input checked="" type="checkbox"/> ... DISTURBED OR BAG SAMPLE	<input checked="" type="checkbox"/> ... CHUNK SAMPLE	<input checked="" type="checkbox"/> ... WATER TABLE OR SEEPAGE

NOTE: THE LOG OF SUBSURFACE CONDITIONS SHOWN HEREON APPLIES ONLY AT THE SPECIFIC BORING OR TRENCH LOCATION AND AT THE DATE INDICATED. IT IS NOT WARRANTED TO BE REPRESENTATIVE OF SUBSURFACE CONDITIONS AT OTHER LOCATIONS AND TIMES.

DEPTH IN FEET	SAMPLE NO.	LITHOLOGY	GROUNDWATER	BORING B 54		PENETRATION RESISTANCE (BLOWS/FT.)	DRY DENSITY (P.C.F.)	MOISTURE CONTENT (%)
				ELEV. (MSL.) 516	DATE COMPLETED 4/6/95			
					EQUIPMENT E-120			
MATERIAL DESCRIPTION								
0				SM	TOPSOIL			
2				GM	Loose, damp, medium to light brown, Silty, fine SAND			
					FRIARS FORMATION Very dense, damp, light brown to orange-brown, Silty, fine to medium Sandy GRAVEL/COBBLE CONGLOMERATE; highly cemented			
					REFUSAL AT 2 FEET			

Figure A-3 Log of Boring B 54, page 1 of 1

FRNC1

SAMPLE SYMBOLS	<input type="checkbox"/>	... SAMPLING UNSUCCESSFUL	<input type="checkbox"/>	... STANDARD PENETRATION TEST	<input checked="" type="checkbox"/>	... DRIVE SAMPLE (UNDISTURBED)
	<input checked="" type="checkbox"/>	... DISTURBED OR BAG SAMPLE	<input checked="" type="checkbox"/>	... CHUNK SAMPLE	<input type="checkbox"/>	... WATER TABLE OR SEEPAGE

NOTE: THE LOG OF SUBSURFACE CONDITIONS SHOWN HEREON APPLIES ONLY AT THE SPECIFIC BORING OR TRENCH LOCATION AND AT THE DATE INDICATED. IT IS NOT WARRANTED TO BE REPRESENTATIVE OF SUBSURFACE CONDITIONS AT OTHER LOCATIONS AND TIMES.

DEPTH IN FEET	SAMPLE NO.	LITHOLOGY	GROUNDWATER	BORING B 55		PENETRATION RESISTANCE (BLOWS/FT.)	DRY DENSITY (P.C.F.)	MOISTURE CONTENT (%)
				SOIL CLASS (USCS)	ELEV. (MSL.) 634 DATE COMPLETED 4/6/95			
EQUIPMENT E-120								
MATERIAL DESCRIPTION								
0				CL/GC	TOPSOIL			
2				CL	Loose, damp, dark brown, fine to medium Sandy CLAY, with gravel/cobble and boulders			
4					Stiff, moist, olive-brown, Silty CLAY			
6	B55-1				FRIARS FORMATION	5	112.9	18.5
8				CL/ML	Hard, damp, olive-grey, Silty CLAYSTONE/Clayey SILTSTONE; blocky and moderately weathered to 5 feet, calcium carbonate pods			
10	B55-2				POSSIBLE BEDDING PLANE SHEAR at 5 feet (8,S15E); undulatory continuous plane in claystone, weathered and obscured, 1/4 inch to 1/2 inch thick, moist, brown, sandy clay along plane (infilling?), no discernible remolding			
12	B55-3				-Becomes less blocky at 6 feet -Grades to clayey siltstone with fine to medium sand at 9 feet	6	110.9	17.3
14								
16	B55-4				-Lense of gravelly/cobble conglomerate from 14.3 to 15.4 feet			
18	B55-5			SM	-Gradational contact at 15.2 feet Very dense, damp, olive-grey to light green, Silty, fine SANDSTONE	5	115.4	16.9
20					-Becomes highly cemented sandstone/siltstone at 20 feet			
22				GM/GC	-Very dense, damp, light brown to light grey, Silty/Clayey GRAVEL/COBBLE CONGLOMERATE; predominant clast size 2 inch to 4 inch with clasts up to 8 inch diameter, highly cemented matrix, very difficult drilling			
24					REFUSAL AT 24 FEET			

Figure A-4 Log of Boring B 55, page 1 of 1

FRNC1

SAMPLE SYMBOLS	□ ... SAMPLING UNSUCCESSFUL	■ ... STANDARD PENETRATION TEST	■ ... DRIVE SAMPLE (UNDISTURBED)
	⊗ ... DISTURBED OR BAG SAMPLE	▣ ... CHUNK SAMPLE	▽ ... WATER TABLE OR SEEPAGE

NOTE: THE LOG OF SUBSURFACE CONDITIONS SHOWN HEREON APPLIES ONLY AT THE SPECIFIC BORING OR TRENCH LOCATION AND AT THE DATE INDICATED. IT IS NOT WARRANTED TO BE REPRESENTATIVE OF SUBSURFACE CONDITIONS AT OTHER LOCATIONS AND TIMES.

DEPTH IN FEET	SAMPLE NO.	LITHOLOGY	GROUNDWATER	BORING B 56		PENETRATION RESISTANCE (BLOWS/FT.)	DRY DENSITY (P.C.F.)	MOISTURE CONTENT (%)
				SOIL CLASS (USCS)	ELEV. (MSL.) <u>602</u> DATE COMPLETED <u>4/6/95</u> EQUIPMENT <u>E-120</u>			
MATERIAL DESCRIPTION								
0				CL	TOPSOIL			
2				CL	Loose, damp, light brown to medium brown, fine to medium Sandy CLAY			
4					Stiff, moist, dark brown, fine to medium Sandy CLAY			
6	B56-1			GC	FRIARS FORMATION Dense, moist, orange-brown, Clayey, fine to very coarse Sandy GRAVEL/ COBBLE/BOULDER CONGLOMERATE; matrix supported, clasts up to 14-inch-diameter, moderately cemented			
8					PRACTICAL REFUSAL AT 8 FEET			

Figure A-5 Log of Boring B 56, page 1 of 1

FRNC1

SAMPLE SYMBOLS	<input type="checkbox"/> ... SAMPLING UNSUCCESSFUL	<input type="checkbox"/> ... STANDARD PENETRATION TEST	<input checked="" type="checkbox"/> ... DRIVE SAMPLE (UNDISTURBED)
	<input checked="" type="checkbox"/> ... DISTURBED OR BAG SAMPLE	<input checked="" type="checkbox"/> ... CHUNK SAMPLE	<input checked="" type="checkbox"/> ... WATER TABLE OR SEEPAGE

NOTE: THE LOG OF SUBSURFACE CONDITIONS SHOWN HEREON APPLIES ONLY AT THE SPECIFIC BORING OR TRENCH LOCATION AND AT THE DATE INDICATED. IT IS NOT WARRANTED TO BE REPRESENTATIVE OF SUBSURFACE CONDITIONS AT OTHER LOCATIONS AND TIMES.

DEPTH IN FEET	SAMPLE NO.	LITHOLOGY	GROUNDWATER	SOIL CLASS (USCS)	BORING B 57		PENETRATION RESISTANCE (BLOWS/FT.)	DRY DENSITY (P.C.F.)	MOISTURE CONTENT (%)
					ELEV. (MSL.) <u>550</u>	DATE COMPLETED <u>4/10/95</u>			
					EQUIPMENT <u>E-120</u>				
MATERIAL DESCRIPTION									
0				CL	TOPSOIL				
2				CL	Loose, dry, brown, Silty CLAY with some fine sand Soft to stiff, moist, dark brown, Silty CLAY				
4				CL/SC/GC	COLLUVIUM Stiff, damp, greyish brown, fine to very coarse Sandy CLAY/Clayey, fine to very coarse SAND with abundant gravel and cobble				
8				CL/ML	LANDSLIDE DEBRIS				
10	B57-1			ML	Stiff to very stiff, damp to moist, light green, Silty CLAY/Clayey SILT -Gradational contact at 9.4 feet	3	108.5	16.9	
12					Medium dense, damp, yellowish brown, Clayey SILTSTONE				
14					Very stiff, damp, light green with reddish brown mottling, Silty CLAYSTONE; weak, waxy, and crumbly				
16	B57-2			CL	-Becomes very stiff to hard and blocky at 13.5 feet; angular claystone clasts up to 4-inch-diameter in clayey matrix -Abundant, discontinuous, low-angle shear surfaces with paper thin gouge in green to reddish brown, waxy claystone below 14 feet -Becomes mottled with yellowish brown oxide staining at 18.5 feet	1	103.4	24.1	
18									
20	B57-3				-Becomes less blocky, moist, stiff, and less waxy at 21 feet	2	105.5	23.1	
22									
24					-Continued discontinuous shears and slip surfaces at 23 feet				
26	B57-4				-Becomes predominantly reddish brown with green mottling at 25 feet	2	107.2	22.2	
28					-Gradational contact at 27 feet				
30	B57-5			CL	Hard, damp, reddish brown with light green mottling, Silty CLAYSTONE, with fine to medium sand				
32					BASAL SLIP PLANE from 31.4 to 32.4 feet (34,S24E); 1/8 inch to 1 inch thick, moist, green, remolded plastic clay, well developed and continuous, irregular thickness, calcium carbonate along plane	4	103.8	24.2	
34					FRIARS FORMATION				
36	B57-6			CL	Hard, damp, light green with reddish brown mottling, Silty CLAYSTONE; waxy and fractured with abundant, discontinuous high-angle shears with clay gouge, disturbed appearance to 35.5 feet				
38				CL	Hard to very hard, damp, reddish brown, Silty CLAYSTONE with some fine sand	5	109.0	21.0	

Figure A-6 Log of Boring B 57, page 1 of 2

FRNC1

SAMPLE SYMBOLS	□ ... SAMPLING UNSUCCESSFUL	□ ... STANDARD PENETRATION TEST	■ ... DRIVE SAMPLE (UNDISTURBED)
	⊠ ... DISTURBED OR BAG SAMPLE	▣ ... CHUNK SAMPLE	▽ ... WATER TABLE OR SEEPAGE

NOTE: THE LOG OF SUBSURFACE CONDITIONS SHOWN HEREON APPLIES ONLY AT THE SPECIFIC BORING OR TRENCH LOCATION AND AT THE DATE INDICATED. IT IS NOT WARRANTED TO BE REPRESENTATIVE OF SUBSURFACE CONDITIONS AT OTHER LOCATIONS AND TIMES.

DEPTH IN FEET	SAMPLE NO.	LITHOLOGY	GROUNDWATER	SOIL CLASS (USCS)	BORING B 57			PENETRATION RESISTANCE (BLOWS/FT.)	DRY DENSITY (P.C.F.)	MOISTURE CONTENT (%)
					ELEV. (MSL.)	DATE COMPLETED	EQUIPMENT			
					ELEV. (MSL.) <u>550</u>	DATE COMPLETED <u>4/10/95</u>	EQUIPMENT <u>E-120</u>			
					MATERIAL DESCRIPTION					
40	B57-7			CL				6	104.7	23.4
42					BORING TERMINATED AT 42 FEET					

Figure A-7 Log of Boring B 57, page 2 of 2

FRNC1

SAMPLE SYMBOLS	<input type="checkbox"/> ... SAMPLING UNSUCCESSFUL	<input type="checkbox"/> ... STANDARD PENETRATION TEST	<input checked="" type="checkbox"/> ... DRIVE SAMPLE (UNDISTURBED)
	<input checked="" type="checkbox"/> ... DISTURBED OR BAG SAMPLE	<input checked="" type="checkbox"/> ... CHUNK SAMPLE	 ... WATER TABLE OR SEEPAGE

NOTE: THE LOG OF SUBSURFACE CONDITIONS SHOWN HEREON APPLIES ONLY AT THE SPECIFIC BORING OR TRENCH LOCATION AND AT THE DATE INDICATED. IT IS NOT WARRANTED TO BE REPRESENTATIVE OF SUBSURFACE CONDITIONS AT OTHER LOCATIONS AND TIMES.

DEPTH IN FEET	SAMPLE NO.	LITHOLOGY	GROUNDWATER	SOIL CLASS (USCS)	BORING B 58		PENETRATION RESISTANCE (BLOWS/FT.)	DRY DENSITY (P.C.F.)	MOISTURE CONTENT (%)
					ELEV. (MSL.) <u>540</u>	DATE COMPLETED <u>4/10/95</u>			
					EQUIPMENT <u>E-120</u>				
MATERIAL DESCRIPTION									
0				ML	TOPSOIL				
2				CL	Loose, damp, medium brown, Clayey SILT with some fine sand and gravels				
4					Stiff, very moist, brown to orange-brown, Silty CLAY, with gravel and cobbles				
6	B58-1			CL/SC/GC	COLLUVIUM				
8					Stiff, moist, greyish brown, fine to very coarse Sandy CLAY/Clayey SAND with abundant gravel, cobbles and boulders up to 18-inch-diameter				
10									
12									
14									
16	B58-2			CL	LANDSLIDE DEBRIS		2	101.7	23.5
18					Very stiff to hard, damp to moist, olive-green to olive-brown, Silty CLAYSTONE; fractured and blocky, manganese oxide staining, waxy/disturbed appearance				
20	B58-3				-Well developed slip plane from 22.3 to 24 feet; (27,N48W) 1/8 inch thick, moist, green, remolded plastic clay, continuous, 1 foot thick zone of soft, moist, micaceous silt/clay above slip plane		1	105.2	21.2
22	B58-4								
24					-Becomes very stiff to hard and very waxy at 24 feet				
26	B58-5			CL	Stiff to very stiff, moist, light green with yellow mottling, Silty CLAYSTONE; waxy and shiny		2	103.9	23.5
28					-Becomes reddish brown and stiff to very stiff clay at 26 feet				
30	B58-6				-Well developed, discontinuous shear with 1/8 inch moist clay gouge at 26.7 feet; 20,S65E				
32					-Well developed slip plane from 28.4 to 29.5 feet; (24,N10E) 1/8 inch to 1/2 inch thick, moist, green remolded plastic clay in reddish brown, stiff clay, continuous		2	98.6	24.8
34					BASAL SLIP PLANE at 31.1 feet (generally horizontal); 1/4 inch to 1.5 inch thick, moist, green, highly remolded plastic clay, continuous and well developed, sharp contact along slip plane between reddish brown clay above and green claystone below, 5-inch-thick zone of weakly remolded clay above slip plane, several secondary discontinuous shears with clay gouge below slip plane				
36	B58-7			CL	FRIARS FORMATION		4	108.4	21.4
38					Very stiff, moist, light green, Silty CLAYSTONE				
					-Becomes hard, damp, waxy and olive-brown at 34.4 feet; color grades from reddish to olive-brown to olive-green				

Figure A-8 Log of Boring B 58, page 1 of 2

FRNC1

SAMPLE SYMBOLS		... SAMPLING UNSUCCESSFUL		... STANDARD PENETRATION TEST		... DRIVE SAMPLE (UNDISTURBED)
		... DISTURBED OR BAG SAMPLE		... CHUNK SAMPLE		... WATER TABLE OR SEEPAGE

NOTE: THE LOG OF SUBSURFACE CONDITIONS SHOWN HEREON APPLIES ONLY AT THE SPECIFIC BORING OR TRENCH LOCATION AND AT THE DATE INDICATED. IT IS NOT WARRANTED TO BE REPRESENTATIVE OF SUBSURFACE CONDITIONS AT OTHER LOCATIONS AND TIMES.

DEPTH IN FEET	SAMPLE NO.	LITHOLOGY	GROUNDWATER	BORING B 58		PENETRATION RESISTANCE (BLOWS/FT.)	DRY DENSITY (P.C.F.)	MOISTURE CONTENT (%)
				SOIL CLASS (USCS)	ELEV. (MSL.) <u>540</u> DATE COMPLETED <u>4/10/95</u>			
					EQUIPMENT <u>E-120</u>			
					MATERIAL DESCRIPTION			
40	B58-8			CL		6	108.6	20.9
42								
44								
BORING TERMINATED AT 45 FEET								

Figure A-9 Log of Boring B 58, page 2 of 2

FRNC1

SAMPLE SYMBOLS	<input type="checkbox"/> ... SAMPLING UNSUCCESSFUL	<input type="checkbox"/> ... STANDARD PENETRATION TEST	<input checked="" type="checkbox"/> ... DRIVE SAMPLE (UNDISTURBED)
	<input checked="" type="checkbox"/> ... DISTURBED OR BAG SAMPLE	<input checked="" type="checkbox"/> ... CHUNK SAMPLE	<input checked="" type="checkbox"/> ... WATER TABLE OR SEEPAGE

NOTE: THE LOG OF SUBSURFACE CONDITIONS SHOWN HEREON APPLIES ONLY AT THE SPECIFIC BORING OR TRENCH LOCATION AND AT THE DATE INDICATED. IT IS NOT WARRANTED TO BE REPRESENTATIVE OF SUBSURFACE CONDITIONS AT OTHER LOCATIONS AND TIMES.

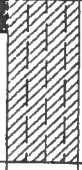







DEPTH IN FEET	SAMPLE NO.	LITHOLOGY	GROUNDWATER	BORING B 59		PENETRATION RESISTANCE (BLOWS/FT.)	DRY DENSITY (P.C.F.)	MOISTURE CONTENT (%)
				SOIL CLASS (USCS)	ELEV. (MSL.) <u>515</u> DATE COMPLETED <u>4/10/95</u> EQUIPMENT <u>E-120</u>			
MATERIAL DESCRIPTION								
0				CL	TOPSOIL			
2				CL/GC	Loose, damp, light brown, Silty CLAY with some fine sand Soft to stiff, moist, light orange-brown, fine to very coarse Sandy, Gravelly/Cobbly CLAY			
4				GC	LANDSLIDE DEBRIS (BASAL MUDFLOW) Stiff, moist, medium brown, Clayey, fine to very coarse Sandy GRAVEL/COBBLE CONGLOMERATE; orange mottling in matrix with boulders up to 24-inch-diameter			
6								
8								
10	B59-1				-Sharp irregular contact, no shearing observed at contact at 8.8 feet GRANITIC ROCK Highly weathered, orange-brown, coarse-grained, moderately weak to moderately strong GRANITIC ROCK; excavates to orange-brown, silty fine to coarse sand -Becomes fractured and moderately strong to strong at 15 feet	5	121.7	11.9
12								
14								
16					-Moderate seepage along fractures at 15 feet			
18								
20								
22								
BORING TERMINATED AT 23 FEET								

Figure A-10 Log of Boring B 59, page 1 of 1

FRNC1

SAMPLE SYMBOLS	 ... SAMPLING UNSUCCESSFUL	 ... STANDARD PENETRATION TEST	 ... DRIVE SAMPLE (UNDISTURBED)
	 ... DISTURBED OR BAG SAMPLE	 ... CHUNK SAMPLE	 ... WATER TABLE OR SEEPAGE

NOTE: THE LOG OF SUBSURFACE CONDITIONS SHOWN HEREON APPLIES ONLY AT THE SPECIFIC BORING OR TRENCH LOCATION AND AT THE DATE INDICATED. IT IS NOT WARRANTED TO BE REPRESENTATIVE OF SUBSURFACE CONDITIONS AT OTHER LOCATIONS AND TIMES.

DEPTH IN FEET	SAMPLE NO.	LITHOLOGY	GROUNDWATER	SOIL CLASS (USCS)	BORING B 60		PENETRATION RESISTANCE (BLOWS/FT.)	DRY DENSITY (P.C.F.)	MOISTURE CONTENT (%)
					ELEV. (MSL.) <u>530</u>	DATE COMPLETED <u>4/11/95</u>			
					EQUIPMENT <u>E-120</u>				
MATERIAL DESCRIPTION									
0				CL	TOPSOIL				
2					Soft, very moist, medium brown to dark brown, Silty CLAY				
4				SM	LANDSLIDE DEBRIS Medium dense, damp to moist, light brown with orange mottling, Silty, fine SANDSTONE; massive, some angular claystone clasts (rip ups?) -Krotavina at 4.4 feet				
6									
8									
10					-Becomes mottled with near-vertical brown clay-filled fractures at 9 feet				
12					-1 inch to 2 inch wide, near vertical fracture filled with brown, clayey sand and calcium carbonate at 11 feet				
14					-Fracture closes at 12.5 feet and is underlain by a series of orange oxide Lamelli along bedding, general attitude 14,S75E				
16				ML	-2 foot thick, irregular concretionary bed at 13 feet -Sharp contact at 14.5 feet; 10,S44E				
18					Dense, damp, grey with orange laminations, Clayey SILTSTONE, with fine sand				
20				SM	-Sharp contact at 17.6 feet; 7,S24E				
22					Medium dense, damp, light brown to orange-brown, Silty, fine SANDSTONE; thinly bedded with orange oxide Lamelli along bedding generally parallel to contact				
24				GC	-6-inch lense of moist, light green, claystone fragments in sandstone matrix at 22.5 feet				
26					Medium dense, moist, light brown to light green, Clayey GRAVEL/COBBLE CONGLOMERATE; irregular contact with predominant clast size 2 inches to 3 inches				
28				CL	Stiff, moist, light green, fine to medium Sandy CLAY				
30				SM-SC-CL	Medium dense, damp, orange-brown with green, interbedded Silty/Clayey SANDSTONE and Silty CLAYSTONE				
32					-Two, 1 inch thick, reddish brown to grey intensely fractured claystone lenses at 28 feet; undulatory, heavy seepage along fractures, minor caving at 27 and 29.5 feet				
34	B60-1				-1-foot-thick lense of soft clay/clayey sand at 31 feet				
36				CL	-Heavy seepage and caving at 31.5 feet, unable to downhole log below 33 feet BASAL SLIP PLANE at 33 feet (unknown orientation); 1 inch to 3 inch thick, soft, moist, green, remolded plastic clay, intensely sheared and pulverized clay above slip plane with angular claystone breccia clasts		83.5	38.8	
38					FRIARS FORMATION (ESTIMATED FROM CUTTINGS) Hard, damp, light green to reddish brown, fine to medium Sandy				

Figure A-11 Log of Boring B 60, page 1 of 2

FRNC1

SAMPLE SYMBOLS	□ ... SAMPLING UNSUCCESSFUL	□ ... STANDARD PENETRATION TEST	■ ... DRIVE SAMPLE (UNDISTURBED)
	▣ ... DISTURBED OR BAG SAMPLE	▣ ... CHUNK SAMPLE	▽ ... WATER TABLE OR SEEPAGE

NOTE: THE LOG OF SUBSURFACE CONDITIONS SHOWN HEREON APPLIES ONLY AT THE SPECIFIC BORING OR TRENCH LOCATION AND AT THE DATE INDICATED. IT IS NOT WARRANTED TO BE REPRESENTATIVE OF SUBSURFACE CONDITIONS AT OTHER LOCATIONS AND TIMES.

DEPTH IN FEET	SAMPLE NO.	LITHOLOGY	GROUNDWATER	SOIL CLASS (USCS)	BORING B 60		PENETRATION RESISTANCE (BLOWS/FT.)	DRY DENSITY (P.C.F.)	MOISTURE CONTENT (%)
					ELEV. (MSL.) <u>530</u>	DATE COMPLETED <u>4/11/95</u>			
					EQUIPMENT <u>E-120</u>				
MATERIAL DESCRIPTION									
40		[Hatched Box]		CL	CLAYSTONE; appearance of cuttings suggest intense fracturing				
42									
44									
46		[Cross-hatched Box]			-Estimated contact at 45 feet				
48			GRANITIC ROCK (ESTIMATED FROM CUTTINGS) Excavates to orange-brown, Silty, fine to coarse SAND						
50									
BORING TERMINATED AT 51 FEET									

Figure A-12 Log of Boring B 60, page 2 of 2

FRNC1

SAMPLE SYMBOLS	<input type="checkbox"/> ... SAMPLING UNSUCCESSFUL	<input type="checkbox"/> ... STANDARD PENETRATION TEST	<input type="checkbox"/> ... DRIVE SAMPLE (UNDISTURBED)
	<input checked="" type="checkbox"/> ... DISTURBED OR BAG SAMPLE	<input type="checkbox"/> ... CHUNK SAMPLE	<input type="checkbox"/> ... WATER TABLE OR SEEPAGE

NOTE: THE LOG OF SUBSURFACE CONDITIONS SHOWN HEREON APPLIES ONLY AT THE SPECIFIC BORING OR TRENCH LOCATION AND AT THE DATE INDICATED. IT IS NOT WARRANTED TO BE REPRESENTATIVE OF SUBSURFACE CONDITIONS AT OTHER LOCATIONS AND TIMES.











DEPTH IN FEET	SAMPLE NO.	LITHOLOGY	GROUNDWATER	SOIL CLASS (USCS)	BORING B 61		PENETRATION RESISTANCE (BLOWS/FT.)	DRY DENSITY (P.C.F.)	MOISTURE CONTENT (%)
					ELEV. (MSL.) <u>570</u>	DATE COMPLETED <u>4/11/95</u>			
					EQUIPMENT <u>E-120</u>				
MATERIAL DESCRIPTION									
0				CL/GC	TOPSOIL Loose, damp, grayish brown, fine Sandy CLAY with abundant gravel and cobble				
2				CL	Stiff, moist, orange-brown, fine to medium Sandy CLAY with scattered gravels				
4				GC	FRIARS FORMATION Very dense, damp, orange-brown, Silty / Clayey, fine to coarse Sandy GRAVEL/COBBLE CONGLOMERATE; Predominant Clast size to 3 to 5 inch with up to 12 inch diameter, difficult drilling				
6									
8					PRACTICAL REFUSAL AT 8 FEET				

Figure A-13 Log of Boring B 61, page 1 of 1

FRNC1

SAMPLE SYMBOLS	 ... SAMPLING UNSUCCESSFUL	 ... STANDARD PENETRATION TEST	 ... DRIVE SAMPLE (UNDISTURBED)
	 ... DISTURBED OR BAG SAMPLE	 ... CHUNK SAMPLE	 ... WATER TABLE OR SEEPAGE

NOTE: THE LOG OF SUBSURFACE CONDITIONS SHOWN HEREON APPLIES ONLY AT THE SPECIFIC BORING OR TRENCH LOCATION AND AT THE DATE INDICATED. IT IS NOT WARRANTED TO BE REPRESENTATIVE OF SUBSURFACE CONDITIONS AT OTHER LOCATIONS AND TIMES.

DEPTH IN FEET	SAMPLE NO.	LITHOLOGY	GROUNDWATER	BORING B 62		PENETRATION RESISTANCE (BLOWS/FT.)	DRY DENSITY (P.C.F.)	MOISTURE CONTENT (%)
				SOIL CLASS (USCS)	ELEV. (MSL.) 580 DATE COMPLETED 4/11/95			
EQUIPMENT E-120								
MATERIAL DESCRIPTION								
0				CL	COLLUVIUM Stiff, moist, medium brown, Silty CLAY; scattered cobbles			
2								
4				SM/SC	TERRACE DEPOSIT ? Dense, damp, green to orange-brown, Clayey, fine to medium SAND/fine to medium Sandy CLAY; scattered gravels fo granitic composition			
6	B62-1					1	84.9	34.7
8					FRIARS FORMATION Very stiff to hard, moist, light green with brown mottling, fine to medium Sandy CLAYSTONE; occasional clasts of highly weathered granitic rock up to 5-inch-diameter (rip ups?), zones of orange-mottled claystone			
10	B62-2			CL		1	84.3	35.8
12	B62-3							
14								
16	B62-4				-Becomes stiff to very stiff at 15 feet	1	81.6	40.4
18								
20	B62-5					2	87.6	35.6
22					-Becomes hard, fractured, and slightly blocky at 22 feet; slight seepage along fractures			
24					-Zones of reddish brown, cemented, fine to coarse sandy claystone below 22 feet			
26	B62-6				-Becomes hard to very hard, light green, and waxy at 25 feet; slight to moderate seepage	2	101.3	25.3
28								
30	B62-7					5	104.3	23.9
32								
34								
BORING TERMINATED AT 35 FEET								

Figure A-14 Log of Boring B 62, page 1 of 1

FRNC1

SAMPLE SYMBOLS	□ ... SAMPLING UNSUCCESSFUL	□ ... STANDARD PENETRATION TEST	■ ... DRIVE SAMPLE (UNDISTURBED)
	⊠ ... DISTURBED OR BAG SAMPLE	▣ ... CHUNK SAMPLE	≡ ... WATER TABLE OR SEEPAGE

NOTE: THE LOG OF SUBSURFACE CONDITIONS SHOWN HEREON APPLIES ONLY AT THE SPECIFIC BORING OR TRENCH LOCATION AND AT THE DATE INDICATED. IT IS NOT WARRANTED TO BE REPRESENTATIVE OF SUBSURFACE CONDITIONS AT OTHER LOCATIONS AND TIMES.

DEPTH IN FEET	SAMPLE NO.	LITHOLOGY	GROUNDWATER	SOIL CLASS (USCS)	BORING B 63		PENETRATION RESISTANCE (BLOWS/FT.)	DRY DENSITY (P.C.F.)	MOISTURE CONTENT (%)
					ELEV. (MSL.) <u>568</u>	DATE COMPLETED <u>4/11/95</u>			
					EQUIPMENT <u>E-120</u>				
MATERIAL DESCRIPTION									
0				CL	TOPSOIL Soft, very moist, reddish brown, Silty CLAY; some gravel fragments				
2									
4				SC/CL	LANDSLIDE DEBRIS (BASAL MUDFLOW) Medium dense, moist, reddish brown, Clayey, fine to medium SAND/fine to medium Sandy CLAY -Becomes gravelly/cobbly with fine to coarse sandy clay/clayey fine to coarse sand matrix at 4 feet	4	131.3	10.9	
6	B63-1								
8									
10	B63-2				-Sharp, undulatory contact, no discernible shearing at 10.4 feet	3	97.6	25.6	
12					GRANITIC ROCK Moderately to highly weathered, light green to grey-brown, coarse grained, strong GRANITIC ROCK; zones of weathered, green clay with relict feldspar grains from 10.4 to 11.4 feet -Becomes slightly to moderately weathered, grey, and very strong at 14 feet				
14									
16	B63-3					5/6"	137.7	6.3	
18									
20									
BORING TERMINATED AT 20 FEET									

Figure A-15 Log of Boring B 63, page 1 of 1

FRNC1

SAMPLE SYMBOLS	<input type="checkbox"/>	... SAMPLING UNSUCCESSFUL	<input type="checkbox"/>	... STANDARD PENETRATION TEST	<input checked="" type="checkbox"/>	... DRIVE SAMPLE (UNDISTURBED)
	<input checked="" type="checkbox"/>	... DISTURBED OR BAG SAMPLE	<input checked="" type="checkbox"/>	... CHUNK SAMPLE	<input type="checkbox"/>	... WATER TABLE OR SEEPAGE

NOTE: THE LOG OF SUBSURFACE CONDITIONS SHOWN HEREON APPLIES ONLY AT THE SPECIFIC BORING OR TRENCH LOCATION AND AT THE DATE INDICATED. IT IS NOT WARRANTED TO BE REPRESENTATIVE OF SUBSURFACE CONDITIONS AT OTHER LOCATIONS AND TIMES.

DEPTH IN FEET	SAMPLE NO.	LITHOLOGY	GROUNDWATER	SOIL CLASS (USCS)	BORING B 64			PENETRATION RESISTANCE (BLOWS/FT.)	DRY DENSITY (P.C.F.)	MOISTURE CONTENT (%)
					ELEV. (MSL.)	DATE COMPLETED	EQUIPMENT			
					ELEV. (MSL.) <u>595</u>	DATE COMPLETED <u>4/11/95</u>				
					EQUIPMENT <u>E-120</u>					
MATERIAL DESCRIPTION										
0					COLLUVIUM Soft, very moist, dark brown, Silty CLAY					
2				CL						
4					Stiff, moist, reddish brown, fine Sandy CLAY					
6	B64-1			CL						
8					Medium dense, damp to moist, reddish brown, Silty/Clayey, fine to coarse Sandy GRAVEL/COBBLE CONGLOMERATE; Poway clasts and angular clasts of granitic rock			3/5"	122.9	9.6
10				GC/CL/SC						
12					-Sharp, undulatory depositional contact at 12.5 to 13.8 feet					
14										
16	B64-2				FRIARS FORMATION Very stiff, moist, light green with orange mottling, Silty CLAYSTONE -Increase in orange-brown mottling at 15 feet -Grades to sandy claystone at 16 feet			2	95.2	29.0
18				CL						
20	B64-3				-Becomes hard, slightly fractured, blocky, and mottled with brown/maroon at 18 feet -Slight seepage along fractures at 20 feet			3	101.2	25.2
22										
24					Grades back and forth from Sandy CLAYSTONE to Clayey SANDSTONE with orange-brown-green mottling					
26	B64-4									
28					-Well developed, continuous fracture with moist green clay along plane from 27.3 to 30.3 feet; no remolding, 50.S86W -Discontinuous, horizontal fracture which is truncated by fracture above at 29.7 feet -Moderate seepage at 30 feet			2	96.1	28.6
30	B64-5									
32					-Moderate seepage at 30 feet			3	100.3	26.3
34										
BORING TERMINATED AT 35 FEET										

Figure A-16 Log of Boring B 64, page 1 of 1

FRNC1

SAMPLE SYMBOLS	<input type="checkbox"/> ... SAMPLING UNSUCCESSFUL	<input type="checkbox"/> ... STANDARD PENETRATION TEST	<input checked="" type="checkbox"/> ... DRIVE SAMPLE (UNDISTURBED)
	<input checked="" type="checkbox"/> ... DISTURBED OR BAG SAMPLE	<input checked="" type="checkbox"/> ... CHUNK SAMPLE	<input checked="" type="checkbox"/> ... WATER TABLE OR SEEPAGE

NOTE: THE LOG OF SUBSURFACE CONDITIONS SHOWN HEREON APPLIES ONLY AT THE SPECIFIC BORING OR TRENCH LOCATION AND AT THE DATE INDICATED. IT IS NOT WARRANTED TO BE REPRESENTATIVE OF SUBSURFACE CONDITIONS AT OTHER LOCATIONS AND TIMES.

DEPTH IN FEET	SAMPLE NO.	LITHOLOGY	GROUNDWATER	BORING B 65		PENETRATION RESISTANCE (BLOWS/FT.)	DRY DENSITY (P.C.F.)	MOISTURE CONTENT (%)
				ELEV. (MSL.) 610	DATE COMPLETED 4/12/95			
EQUIPMENT E-120								
MATERIAL DESCRIPTION								
0								
2				CH	COLLUVIUM Soft to stiff, very moist, dark brown, Silty CLAY -Becomes olive-brown with some gravel fragments at 4 feet -Becomes moist and stiff to very stiff at 6.5 feet	PUSH	89.1	31.4
4	B65-1							
6				CL	-Very stiff to hard, moist, orange-brown, fine Sandy CLAY			
8				GC	-Gradational contact at 11.5 feet Medium dense, damp, light orange-brown, Clayey, fine to medium Sandy GRAVEL/COBBLE CONGLOMERATE			
10								
12								
14								
16	B65-2			CL	-Sharp, undulatory, depositional contact at 15 feet FRIARS FORMATION Very stiff, moist, orange-brown to maroon with green mottling, fine Sandy CLAYSTONE -Becomes very stiff to hard at 17 feet	1	93.7	29.2
18								
20	B65-3			CL	-Hard, damp, reddish brown with light green mottling, fine to medium Sandy CLAYSTONE; slightly blocky	3	97.2	27.6
22								
24								
26								
28								
30					BORING TERMINATED AT 30 FEET			

Figure A-17 Log of Boring B 65, page 1 of 1

FRNC1

SAMPLE SYMBOLS	... SAMPLING UNSUCCESSFUL	... STANDARD PENETRATION TEST	... DRIVE SAMPLE (UNDISTURBED)
	... DISTURBED OR BAG SAMPLE	... CHUNK SAMPLE	... WATER TABLE OR SEEPAGE

NOTE: THE LOG OF SUBSURFACE CONDITIONS SHOWN HEREON APPLIES ONLY AT THE SPECIFIC BORING OR TRENCH LOCATION AND AT THE DATE INDICATED. IT IS NOT WARRANTED TO BE REPRESENTATIVE OF SUBSURFACE CONDITIONS AT OTHER LOCATIONS AND TIMES.

DEPTH IN FEET	SAMPLE NO.	LITHOLOGY	GROUNDWATER	BORING B 78		PENETRATION RESISTANCE (BLOWS/FT.)	DRY DENSITY (P.C.F.)	MOISTURE CONTENT (%)
				ELEV. (MSL.) <u>540</u>	DATE COMPLETED <u>7/13/95</u>			
				EQUIPMENT <u>E-120</u>				
MATERIAL DESCRIPTION								
0								
2			GC	LANDSLIDE DEBRIS Medium dense, damp, light brown, Clayey Sandy GRAVEL/COBBLE CONGLOMERATE; clasts size ranges from 2 inch to 24 inch				
4								
6								
8								
10								
12								
14								
16								
18								
20								
22								
24								
26								
28								
30								
32								
34								
36								
38								

Figure A-18 Log of Boring B 78, page 1 of 2

FRNC1

SAMPLE SYMBOLS	<input type="checkbox"/>	... SAMPLING UNSUCCESSFUL	<input type="checkbox"/>	... STANDARD PENETRATION TEST	<input type="checkbox"/>	... DRIVE SAMPLE (UNDISTURBED)
	<input checked="" type="checkbox"/>	... DISTURBED OR BAG SAMPLE	<input type="checkbox"/>	... CHUNK SAMPLE	<input type="checkbox"/>	... WATER TABLE OR SEEPAGE

NOTE: THE LOG OF SUBSURFACE CONDITIONS SHOWN HEREON APPLIES ONLY AT THE SPECIFIC BORING OR TRENCH LOCATION AND AT THE DATE INDICATED. IT IS NOT WARRANTED TO BE REPRESENTATIVE OF SUBSURFACE CONDITIONS AT OTHER LOCATIONS AND TIMES.

DEPTH IN FEET	SAMPLE NO.	LITHOLOGY	GROUNDWATER	SOIL CLASS (USCS)	BORING B 78		PENETRATION RESISTANCE (BLOWS/FT.)	DRY DENSITY (P.C.F.)	MOISTURE CONTENT (%)
					ELEV. (MSL.) <u>540</u>	DATE COMPLETED <u>7/13/95</u>			
					EQUIPMENT <u>E-120</u>				
40					MATERIAL DESCRIPTION				
42									
					BORING TERMINATED AT 43 FEET PRACTICAL REFUSAL AT 43 FEET; BORING LOGGED FROM SURFACE DUE TO BELLING AND CAVING				

Figure A-19 Log of Boring B 78, page 2 of 2

FRNC1

SAMPLE SYMBOLS	<input type="checkbox"/> ... SAMPLING UNSUCCESSFUL	<input type="checkbox"/> ... STANDARD PENETRATION TEST	<input checked="" type="checkbox"/> ... DRIVE SAMPLE (UNDISTURBED)
	<input checked="" type="checkbox"/> ... DISTURBED OR BAG SAMPLE	<input checked="" type="checkbox"/> ... CHUNK SAMPLE	<input checked="" type="checkbox"/> ... WATER TABLE OR SEEPAGE

NOTE: THE LOG OF SUBSURFACE CONDITIONS SHOWN HEREON APPLIES ONLY AT THE SPECIFIC BORING OR TRENCH LOCATION AND AT THE DATE INDICATED. IT IS NOT WARRANTED TO BE REPRESENTATIVE OF SUBSURFACE CONDITIONS AT OTHER LOCATIONS AND TIMES.

DEPTH IN FEET	SAMPLE NO.	LITHOLOGY	GROUNDWATER	BORING B 79		PENETRATION RESISTANCE (BLOWS/FT.)	DRY DENSITY (P.C.F.)	MOISTURE CONTENT (%)
				SOIL CLASS (USCS)	ELEV. (MSL.) <u>535</u> DATE COMPLETED <u>7/14/95</u>			
EQUIPMENT <u>E-120</u>								
MATERIAL DESCRIPTION								
0								
2					LANDSLIDE DEBRIS Medium dense, damp to moist, light brown, Clayey SAND/Sandy CLAY with cobbles			
4				SC/CL				
6					-Zone of soft, moist, green highly sheared clay from 11.6 to 13.8 feet (poorly developed slip surface); 30,N15E			
8								
10								
12	B79-1			CL	-Contact sharp, irregular at 11 feet Stiff to hard, damp to moist, olive green, Silty CLAYSTONE; highly weathered and brecciated, remolded at contact	2	101.1	24.6
14					-Zone of soft, moist, green highly sheared clay with several poorly developed slip surfaces from 11.5 to 13.5 feet			
16	B79-2			CL	-Shear at 13 feet, dipping 16 degrees due north Hard, moist, pink to olive green, Silty CLAYSTONE; highly fractured with manganese staining along randomly oriented fractures	1	99.6	24.9
18	B79-3				-Shear at 14.5 feet dipping 5 degrees due east			
20					-Shear at 17.5 feet, dipping 12 degrees due south			
22					-Shear at 18 feet dipping 30 degrees due west BASAL SLIP PLANE at 21.5 feet (20,S35W); well developed soft clay gouge			
24				CL	FRIARS FORMATION Hard, damp, green, Sandy CLAYSTONE; waxy texture, few granitic clasts			
26					-Shear in highly polished claystone at 26 feet; slickensides 38,N68E			
28					-Joint at 27 feet; N50W,80NE			
30					BORING TERMINATED AT 30 FEET			

Figure A-20 Log of Boring B 79, page 1 of 1

FRNC1

SAMPLE SYMBOLS	<input type="checkbox"/> ... SAMPLING UNSUCCESSFUL	<input type="checkbox"/> ... STANDARD PENETRATION TEST	<input checked="" type="checkbox"/> ... DRIVE SAMPLE (UNDISTURBED)
	<input checked="" type="checkbox"/> ... DISTURBED OR BAG SAMPLE	<input checked="" type="checkbox"/> ... CHUNK SAMPLE	<input checked="" type="checkbox"/> ... WATER TABLE OR SEEPAGE

NOTE: THE LOG OF SUBSURFACE CONDITIONS SHOWN HEREON APPLIES ONLY AT THE SPECIFIC BORING OR TRENCH LOCATION AND AT THE DATE INDICATED. IT IS NOT WARRANTED TO BE REPRESENTATIVE OF SUBSURFACE CONDITIONS AT OTHER LOCATIONS AND TIMES.

DEPTH IN FEET	SAMPLE NO.	LITHOLOGY	GROUNDWATER	SOIL CLASS (USCS)	BORING B 80		PENETRATION RESISTANCE (BLOWS/FT.)	DRY DENSITY (P.C.F.)	MOISTURE CONTENT (%)
					ELEV. (MSL.) <u>615</u>	DATE COMPLETED <u>7/14/95</u>			
					EQUIPMENT <u>E-120</u>				
MATERIAL DESCRIPTION									
0				SM/CL	TOPSOIL Loose, dry brown, Silty SAND/Sandy CLAY				
2					LANDSLIDE DEBRIS Medium dense, moist, brown, Clayey SAND with cobbles				
4									
6	B80-1			SC					
8									
10									
12					-Contact approximately horizontal				
14				CL	Firm, moist, grey-green to reddish-brown, Silty CLAYSTONE; highly fractured and sheared, caliche present along fractures				
16	B80-2				-Shear at 14 feet: 40, S30E -Shear at 15.5 feet: 24, S40W	2	102.4	23.8	
18					BASAL SLIP PLANE at 17.7 feet (3 to 5, S40W); 5 inch thick zone of sheared claystone				
20	B80-3			SC/CL	FRIARS FORMATION Dense, moist, green to reddish-brown, Sandstone/Sandy CLAYSTONE	8	110.3	19.5	
22					-Grades to very dense, moist, light brown, silty fine grained clayey sandstone at 21 feet				
24					Contact sharp with poorly developed BEDDING PLANE SHEAR; 12, N70W, 1/16 inch thick gouge				
26	B80-4			CL	Hard, moist, olive green CLAYSTONE; fractured	9	116.5	16.8	
28					-Shear at 25.5 feet: 45, S13E -Sharp contact and undulatory				
30	B80-5			CL	Hard, moist, olive green to reddish brown waxy CLAYSTONE; fractured				
32					-1 foot thick, very dense, cemented concretionary bed at 28 feet -Shear at 29 feet; 50, S30W	9	112.3	18.2	
34									
36				SM	Very dense, damp to moist, light brown, Silty SANDSTONE; some highly weathered granitic clasts, some caliche and iron staining, micaceous				
38					GRANITIC ROCK Moderately to highly weathered, yellow brown to brown, weak, GRANITIC ROCK				
BORING TERMINATED AT 38 FEET									

Figure A-21 Log of Boring B 80, page 1 of 1

FRNC1

SAMPLE SYMBOLS	<input type="checkbox"/>	... SAMPLING UNSUCCESSFUL	<input type="checkbox"/>	... STANDARD PENETRATION TEST	<input checked="" type="checkbox"/>	... DRIVE SAMPLE (UNDISTURBED)
	<input checked="" type="checkbox"/>	... DISTURBED OR BAG SAMPLE	<input checked="" type="checkbox"/>	... CHUNK SAMPLE	<input type="checkbox"/>	... WATER TABLE OR SEEPAGE

NOTE: THE LOG OF SUBSURFACE CONDITIONS SHOWN HEREON APPLIES ONLY AT THE SPECIFIC BORING OR TRENCH LOCATION AND AT THE DATE INDICATED. IT IS NOT WARRANTED TO BE REPRESENTATIVE OF SUBSURFACE CONDITIONS AT OTHER LOCATIONS AND TIMES.

DEPTH IN FEET	SAMPLE NO.	LITHOLOGY	GROUNDWATER	SOIL CLASS (USCS)	BORING B 81		PENETRATION RESISTANCE (BLOWS/FT.)	DRY DENSITY (P.C.F.)	MOISTURE CONTENT (%)
					ELEV. (MSL.) 620	DATE COMPLETED 7/17/95			
					EQUIPMENT E-120				
MATERIAL DESCRIPTION									
0					LANDSLIDE DEBRIS				
2					Loose to medium dense, damp, dark reddish-brown, Silty SAND with gravel and cobbles, some clay				
4	B81-1			SM					
6					-Seepage, caving at 6 feet; boring logged from the surface due to unsafe conditions				
8									
10	B81-2				Soft to firm, very moist, medium brown to olive green, Sandy CLAY with gravels and cobbles				
12									
14									
16				CL			3		
18					-No sample recovery at 15 feet				
20									
22									
24	B81-3				Soft to firm, moist, olive green, Silty CLAYSTONE; highly fractured and brecciated		2	102.7	22.8
26	B81-4			CL					35.2
28					-Shear zone at approximately at 25.5 feet; soft, light green, remolded clay				
30	B81-5				BASAL SLIP PLANE at approximately 30 feet; soft, wet, grey, remolded plastic clay			90.6	33.5
32	B81-6				GRANITIC ROCK		10		
34					Highly weathered, yellow brown to brown, coarse grained, moderately strong GRANITIC ROCK				
BORING TERMINATED AT 35 FEET									

Figure A-22 Log of Boring B 81, page 1 of 1

FRNC1

SAMPLE SYMBOLS	□ ... SAMPLING UNSUCCESSFUL	□ ... STANDARD PENETRATION TEST	■ ... DRIVE SAMPLE (UNDISTURBED)
	⊠ ... DISTURBED OR BAG SAMPLE	▣ ... CHUNK SAMPLE	≡ ... WATER TABLE OR SEEPAGE

NOTE: THE LOG OF SUBSURFACE CONDITIONS SHOWN HEREON APPLIES ONLY AT THE SPECIFIC BORING OR TRENCH LOCATION AND AT THE DATE INDICATED. IT IS NOT WARRANTED TO BE REPRESENTATIVE OF SUBSURFACE CONDITIONS AT OTHER LOCATIONS AND TIMES.

DEPTH IN FEET	SAMPLE NO.	LITHOLOGY	GROUNDWATER	SOIL CLASS (USCS)	BORING B 82		PENETRATION RESISTANCE (BLOWS/FT.)	DRY DENSITY (P.C.F.)	MOISTURE CONTENT (%)
					ELEV. (MSL.) 605	DATE COMPLETED 7/17/95			
					EQUIPMENT				
					E-120				
MATERIAL DESCRIPTION									
0				CL	TOPSOIL Firm, damp, brown, Sandy CLAY				
2				SM	LANDSLIDE DEBRIS Medium dense, damp, brown, Silty SAND with cobbles; zones of soft, moist, grey brown clay with caliche filled fractures				
6	B82-1			CL	Hard, damp, brown, Silty CLAYSTONE; highly fractured to brecciated		2	105.3	21.0
8	B82-2				-Becomes green-brown at 9 feet				
12	B82-3			CL	BASAL SLIP PLANE at 11.8 feet (generally horizontal); 2 inch thick, moist, grey, remolded plastic clay		3	104.9	21.6
14				CL	FRIARS FORMATION Hard, damp, green, Silty CLAYSTONE; waxy texture with concoidal fracturing				
18	B82-4				-Zone of highly weathered claystone approximately 2 feet thick at 17 feet; contains 3 inch thick zone of soft sheared clay with caliche infilling, no preferred orientation		4	110.4	20.3
22	B82-5				-Gradational contact				
24	B82-6			SM	Dense, moist, light grey, Silty, fine to medium, massively bedded SANDSTONE; occasional cobbles		6	118.6	16.1
26									
28									
30									
32									
BORING TERMINATED AT 33 FEET									

Figure A-23 Log of Boring B 82, page 1 of 1

FRNC1

SAMPLE SYMBOLS	<input type="checkbox"/>	... SAMPLING UNSUCCESSFUL	<input type="checkbox"/>	... STANDARD PENETRATION TEST	<input checked="" type="checkbox"/>	... DRIVE SAMPLE (UNDISTURBED)
	<input checked="" type="checkbox"/>	... DISTURBED OR BAG SAMPLE	<input type="checkbox"/>	... CHUNK SAMPLE	<input type="checkbox"/>	... WATER TABLE OR SEEPAGE

NOTE: THE LOG OF SUBSURFACE CONDITIONS SHOWN HEREON APPLIES ONLY AT THE SPECIFIC BORING OR TRENCH LOCATION AND AT THE DATE INDICATED. IT IS NOT WARRANTED TO BE REPRESENTATIVE OF SUBSURFACE CONDITIONS AT OTHER LOCATIONS AND TIMES.

DEPTH IN FEET	SAMPLE NO.	LITHOLOGY	GROUNDWATER	BORING B 83		PENETRATION RESISTANCE (BLOWS/FT.)	DRY DENSITY (P.C.F.)	MOISTURE CONTENT (%)
				SOIL CLASS (USCS)	ELEV. (MSL.) <u>602</u> DATE COMPLETED <u>7/18/95</u>			
EQUIPMENT <u>E-120</u>								
MATERIAL DESCRIPTION								
0					TOPSOIL/COLLUVIUM Loose to very firm, dry, grey brown, Sandy CLAY with cobbles			
2				CL				
4					-Grades to clayey sand and cobbles at 4 feet			
6					LANDSLIDE DEBRIS Medium dense, damp, grey brown, Silty CLAYSTONE; highly fractured with few 1/16 inch wide discontinuous open fractures			
8	B83-1			CL		1	102.5	23.4
10	B83-7				-Well developed shear surface with soft clay gouge at 9 feet: 20 to 35, N20E -Subparallel shear to the above surface at 10 feet: 20 to 35, N20E			
12					BASAL SLIP PLANE at 11.6 feet (approximately 2 degrees dip NE); 2-inch thick, moist, grey, remolded plastic clay, brecciated			
14	B83-2			CL		3	109.9	19.8
16					FRIARS FORMATION Hard, damp, grey-green, Silty CLAYSTONE; blocky and waxy texture, highly fractured, minor shear and thin clay gouge above contact, few high angle shears below contact			
18	B83-3			ML/CL		4	108.6	19.8
20					Firm to stiff, moist, grey-green to red-brown, Siltstone/Claystone; highly fissured with randomly oriented polished surfaces -Shear at 18.2 feet: 30, S20E -Joint at 20.1 feet: N20W, 80NE			
22								
24	B83-4				-Gradational contact	5	104.8	19.9
26				SM/CL	Dense, moist, light brown, Silty SANDSTONE/Sandy CLAYSTONE			
28	B83-5			CL	-Joints at 27 feet: N30E, 75NW, N80W, 75NE -Gradational contact			
30					Very hard, damp, light brown, Silty CLAYSTONE BEDDING PLANE SHEAR at 29.2 feet (2, N70E); 1/4 inch thick, moist, remolded plastic clay, well developed	8	106.8	20.8
32	B83-6				GRANITIC ROCK Moderately weathered, light brown, coarse, moderately strong GRANITIC ROCK			
BORING TERMINATED AT 33 FEET								

Figure A-24 Log of Boring B 83, page 1 of 1

FRNC1

SAMPLE SYMBOLS	<input type="checkbox"/>	... SAMPLING UNSUCCESSFUL	<input type="checkbox"/>	... STANDARD PENETRATION TEST	<input type="checkbox"/>	... DRIVE SAMPLE (UNDISTURBED)
	<input checked="" type="checkbox"/>	... DISTURBED OR BAG SAMPLE	<input type="checkbox"/>	... CHUNK SAMPLE	<input type="checkbox"/>	... WATER TABLE OR SEEPAGE

NOTE: THE LOG OF SUBSURFACE CONDITIONS SHOWN HEREON APPLIES ONLY AT THE SPECIFIC BORING OR TRENCH LOCATION AND AT THE DATE INDICATED. IT IS NOT WARRANTED TO BE REPRESENTATIVE OF SUBSURFACE CONDITIONS AT OTHER LOCATIONS AND TIMES.

BORING B 84					PENETRATION RESISTANCE (BLOMS/FT.)	DRY DENSITY (P.C.F.)	MOISTURE CONTENT (%)
DEPTH IN FEET	SAMPLE NO.	LITHOLOGY	GROUNDWATER	SOIL CLASS (USCS)			
ELEV. (MSL.) <u>600</u> DATE COMPLETED <u>7/18/95</u>							
EQUIPMENT <u>E-120</u>							
MATERIAL DESCRIPTION							
0							
2				CL			
TOPSOIL/COLLUVIUM Loose to very firm, damp to moist, dark brown, Sandy CLAY with cobbles							
4				CL			
LANDSLIDE DEBRIS Firm, moist, olive green to red brown, Silty CLAYSTONE; locally brecciated							
6	B84-1				1/2 /12"	100.7	24.1
6	B84-2						
BASAL SLIP PLANE at 6.8 feet (11,N75W); 18 inch thick, poorly remolded shear zone, well defined slip plane							
8							
FRIARS FORMATION Firm, moist, olive green to reddish brown, Silty CLAYSTONE; fractured with abundant calcium carbonate along fractures and in lenticular pods							
10							
12	B84-3			CL	4	104.0	20.4
14							
1 inch thick SHEAR ZONE in claystone at 14 feet: 18,N65E (apparent zone of microbreccia)							
16	B84-4				5	109.0	17.2
16							
-Highly fractured at 15 feet							
18							
-Fractured filled with calcium carbonate at 16 feet: 20,N73W							
18							
-Contact, irregular and locally steep							
20							
GRANITIC ROCK Moderately weathered, yellow brown, coarse, strong, GRANITIC ROCK							
BORING TERMINATED AT 20 FEET							

Figure A-25 Log of Boring B 84, page 1 of 1

FRNC1

SAMPLE SYMBOLS	<input type="checkbox"/> ... SAMPLING UNSUCCESSFUL	<input type="checkbox"/> ... STANDARD PENETRATION TEST	<input checked="" type="checkbox"/> ... DRIVE SAMPLE (UNDISTURBED)
	<input checked="" type="checkbox"/> ... DISTURBED OR BAG SAMPLE	<input checked="" type="checkbox"/> ... CHUNK SAMPLE	<input checked="" type="checkbox"/> ... WATER TABLE OR SEEPAGE

NOTE: THE LOG OF SUBSURFACE CONDITIONS SHOWN HEREON APPLIES ONLY AT THE SPECIFIC BORING OR TRENCH LOCATION AND AT THE DATE INDICATED. IT IS NOT WARRANTED TO BE REPRESENTATIVE OF SUBSURFACE CONDITIONS AT OTHER LOCATIONS AND TIMES.



DEPTH IN FEET	SAMPLE NO.	LITHOLOGY	GROUNDWATER	BORING B 85		PENETRATION RESISTANCE (BLOWS/FT.)	DRY DENSITY (P.C.F.)	MOISTURE CONTENT (%)					
				SOIL CLASS (USCS)	ELEV. (MSL.) <u>555</u> DATE COMPLETED <u>7/18/95</u> EQUIPMENT <u>E-120</u>								
MATERIAL DESCRIPTION													
0				SC-CL	TOPSOIL/COLLUVIUM Loose to medium dense, medium brown, Clayey SAND/Sandy CLAY with abundant gravel and cobble								
2													
4													
6													
8													
10							GM/GC	-Gradational contact, no shearing evident FRIARS FORMATION Dense, damp, light brown, Silty/Clayey, fine to medium Sandy COBBLE CONGLOMERATE; moderately to highly cemented					
12													
14													
REFUSAL AT 15 FEET													

Figure A-26 Log of Boring B 85, page 1 of 1

FRNC1

SAMPLE SYMBOLS	<input type="checkbox"/> ... SAMPLING UNSUCCESSFUL	<input type="checkbox"/> ... STANDARD PENETRATION TEST	<input type="checkbox"/> ... DRIVE SAMPLE (UNDISTURBED)
	<input checked="" type="checkbox"/> ... DISTURBED OR BAG SAMPLE	<input checked="" type="checkbox"/> ... CHUNK SAMPLE	<input checked="" type="checkbox"/> ... WATER TABLE OR SEEPAGE

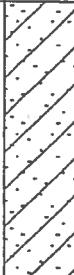
NOTE: THE LOG OF SUBSURFACE CONDITIONS SHOWN HEREON APPLIES ONLY AT THE SPECIFIC BORING OR TRENCH LOCATION AND AT THE DATE INDICATED. IT IS NOT WARRANTED TO BE REPRESENTATIVE OF SUBSURFACE CONDITIONS AT OTHER LOCATIONS AND TIMES.

DEPTH IN FEET	SAMPLE NO.	LITHOLOGY	GROUNDWATER	TRENCH T 87		PENETRATION RESISTANCE (BLOWS/FT.)	DRY DENSITY (P.C.F.)	MOISTURE CONTENT (%)
				SOIL CLASS (USCS)	ELEV. (MSL.) <u>462</u> DATE COMPLETED <u>4/6/95</u> EQUIPMENT <u>JD 555</u>			
MATERIAL DESCRIPTION								
0				SM	TOPSOIL Loose to medium dense, moist, dark reddish brown, Silty, fine to medium SAND with few 3 inch diameter cobbles			
2				GC	TERRACE DEPOSITS Medium dense to dense, moist, dark grayish brown, Clayey, fine to medium Sandy COBBLE CONGLOMERATE; predominant clast size 3 inches to 5 inches with maximum up to 8 inches; matrix supported; some orange oxide staining			
4				SC		Dense, damp, light grayish brown, Clayey, fine to medium SANDSTONE; decrease in orange oxide staining		
6								
BOTTOM OF TRENCH AT 7 FEET								

Figure A-27, Log of Trench T 87

FRNC1

SAMPLE SYMBOLS	<input type="checkbox"/> ... SAMPLING UNSUCCESSFUL	<input type="checkbox"/> ... STANDARD PENETRATION TEST	<input type="checkbox"/> ... DRIVE SAMPLE (UNDISTURBED)
	<input checked="" type="checkbox"/> ... DISTURBED OR BAG SAMPLE	<input type="checkbox"/> ... CHUNK SAMPLE	<input type="checkbox"/> ... WATER TABLE OR SEEPAGE

NOTE: THE LOG OF SUBSURFACE CONDITIONS SHOWN HEREON APPLIES ONLY AT THE SPECIFIC BORING OR TRENCH LOCATION AND AT THE DATE INDICATED. IT IS NOT WARRANTED TO BE REPRESENTATIVE OF SUBSURFACE CONDITIONS AT OTHER LOCATIONS AND TIMES.

PROJECT NO. 05254-52-02

DEPTH IN FEET	SAMPLE NO.	LITHOLOGY	GROUNDWATER	SOIL CLASS (USCS)	TRENCH T 88		PENETRATION RESISTANCE (BLOWS/FT.)	DRY DENSITY (P.C.F.)	MOISTURE CONTENT (%)
					ELEV. (MSL.) 462	DATE COMPLETED 4/6/95			
					EQUIPMENT JD 555				
MATERIAL DESCRIPTION									
0				SC/GC	ALLUVIUM Loose to medium dense, moist, brown, Clayey, fine to medium SAND with some coarse gravel; rootlets Soft, very moist to wet, dark brown, fine to medium Sandy CLAY with some coarse gravel -Slight to moderate seepage at 2 feet -Becomes dark orangish brown with 3 inch to 4 inch diameter cobbles at 7 feet; maximum clast size 6 inches -Becomes coarser grained with an increase in gravel percentage at 8 feet				
2			CL/GC						
4					SC/GC	TERRACE DEPOSITS Medium dense to dense, moist, orangish brown, Clayey, fine to medium SAND with coarse gravel and 4 inch to 6 inch diameter cobbles, maximum clast size 8 inches			
12					BOTTOM OF TRENCH AT 14 FEET TRENCH LOGGED FROM SURFACE				
14									

Figure A-28, Log of Trench T 88

FRNC1

SAMPLE SYMBOLS	... SAMPLING UNSUCCESSFUL	... STANDARD PENETRATION TEST	... DRIVE SAMPLE (UNDISTURBED)
	... DISTURBED OR BAG SAMPLE	... CHUNK SAMPLE	... WATER TABLE OR SEEPAGE

NOTE: THE LOG OF SUBSURFACE CONDITIONS SHOWN HEREON APPLIES ONLY AT THE SPECIFIC BORING OR TRENCH LOCATION AND AT THE DATE INDICATED. IT IS NOT WARRANTED TO BE REPRESENTATIVE OF SUBSURFACE CONDITIONS AT OTHER LOCATIONS AND TIMES.

DEPTH IN FEET	SAMPLE NO.	LITHOLOGY	GROUNDWATER	SOIL CLASS (USCS)	TRENCH T 89		PENETRATION RESISTANCE (BLOWS/FT.)	DRY DENSITY (P.C.F.)	MOISTURE CONTENT (%)
					ELEV. (MSL.) 472	DATE COMPLETED 4/6/95			
					MATERIAL DESCRIPTION				
0					ALLUVIUM Loose, wet, dark brown, Silty/Clayey, fine to medium SAND with some coarse gravel and 3 inch to 5 inch diameter cobbles, maximum clast size 8 inches -Heavy seepage and caving below 1 foot				
2									
4	T89-1			SC/GC					
6					Medium dense, saturated, brown, fine to coarse Sandy GRAVEL with 3 inch to 5 inch diameter cobble, trace of clay				
8				GP					
10					TERRACE DEPOSITS ?/FRIARS FORMATION ? Medium dense, moist, light orangish brown to yellowish brown, Clayey, fine to medium SAND with trace of coarse sand; few 3 inch diameter cobbles TRENCH TERMINATED AT 12 FEET DUE TO CAVING TRENCH LOGGED FROM SURFACE				
12				SC					

Figure A-29, Log of Trench T 89

FRNC1

SAMPLE SYMBOLS		... SAMPLING UNSUCCESSFUL		... STANDARD PENETRATION TEST		... DRIVE SAMPLE (UNDISTURBED)
		... DISTURBED OR BAG SAMPLE		... CHUNK SAMPLE		... WATER TABLE OR SEEPAGE

NOTE: THE LOG OF SUBSURFACE CONDITIONS SHOWN HEREON APPLIES ONLY AT THE SPECIFIC BORING OR TRENCH LOCATION AND AT THE DATE INDICATED. IT IS NOT WARRANTED TO BE REPRESENTATIVE OF SUBSURFACE CONDITIONS AT OTHER LOCATIONS AND TIMES.

PROJECT NO. 05254-52-02

DEPTH IN FEET	SAMPLE NO.	LITHOLOGY	GROUNDWATER	TRENCH T 90		PENETRATION RESISTANCE (BLOWS/FT.)	DRY DENSITY (P.C.F.)	MOISTURE CONTENT (%)
				SOIL CLASS (USCS)	ELEV. (MSL.) <u>485</u> DATE COMPLETED <u>4/6/95</u> EQUIPMENT <u>JD 555</u>			
MATERIAL DESCRIPTION								
0				SM/GM ALLUVIUM Loose, very moist, brown, Silty, fine to medium SAND with fine to coarse gravel and 3 inch to 5 inch diameter cobbles, maximum clast size 8 inches -Heavy seepage and caving below 2 feet				
2								
4								
6								
8								
10								
				SC/GC TERRACE DEPOSITS Dense, moist, yellowish brown, Clayey, fine to medium SAND with coarse gravel and 3 inch to 5 inch diameter cobbles TRENCH TERMINATED AT 11 FEET DUE TO CAVING TRENCH LOGGED FROM SURFACE				

Figure A-30, Log of Trench T 90

FRNC1

SAMPLE SYMBOLS	<input type="checkbox"/>	... SAMPLING UNSUCCESSFUL	<input type="checkbox"/>	... STANDARD PENETRATION TEST	<input type="checkbox"/>	... DRIVE SAMPLE (UNDISTURBED)
	<input checked="" type="checkbox"/>	... DISTURBED OR BAG SAMPLE	<input type="checkbox"/>	... CHUNK SAMPLE		... WATER TABLE OR SEEPAGE

NOTE: THE LOG OF SUBSURFACE CONDITIONS SHOWN HEREON APPLIES ONLY AT THE SPECIFIC BORING OR TRENCH LOCATION AND AT THE DATE INDICATED. IT IS NOT WARRANTED TO BE REPRESENTATIVE OF SUBSURFACE CONDITIONS AT OTHER LOCATIONS AND TIMES.











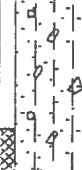

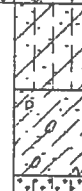
DEPTH IN FEET	SAMPLE NO.	LITHOLOGY	GROUNDWATER	SOIL CLASS (USCS)	TRENCH T 91		PENETRATION RESISTANCE (BLOWS/FT.)	DRY DENSITY (P.C.F.)	MOISTURE CONTENT (%)
					ELEV. (MSL.)	DATE COMPLETED			
					ELEV. (MSL.)	470	DATE COMPLETED	4/6/95	
					EQUIPMENT	JD 555			
MATERIAL DESCRIPTION									
0									
2	T91-1			SM/GM	ALLUVIUM Loose to medium dense, damp to moist, brown, Silty, fine to medium SAND with 3 inch to 4 inch diameter cobbles; occasional 12 inch to 14 inch boulder -Becomes moist at 2 feet -Slight to moderate seepage at 4 feet				
4									
6				SC/GC	Medium dense, wet, dark reddish brown, Silty, fine to medium SAND with trace of coarse sand and clay				
8									
10				SM	FRIARS FORMATION Dense, damp, light yellowish brown, Silty, fine to medium SANDSTONE with a trace of clay; slightly cemented				
BOTTOM OF TRENCH AT 10 FEET TRENCH LOGGED FROM SURFACE									

Figure A-31, Log of Trench T 91

FRNC1

SAMPLE SYMBOLS		... SAMPLING UNSUCCESSFUL		... STANDARD PENETRATION TEST		... DRIVE SAMPLE (UNDISTURBED)
		... DISTURBED OR BAG SAMPLE		... CHUNK SAMPLE		... WATER TABLE OR SEEPAGE

NOTE: THE LOG OF SUBSURFACE CONDITIONS SHOWN HEREON APPLIES ONLY AT THE SPECIFIC BORING OR TRENCH LOCATION AND AT THE DATE INDICATED. IT IS NOT WARRANTED TO BE REPRESENTATIVE OF SUBSURFACE CONDITIONS AT OTHER LOCATIONS AND TIMES.

PROJECT NO. 05254-52-02



DEPTH IN FEET	SAMPLE NO.	LITHOLOGY	GROUNDWATER	TRENCH T 92		PENETRATION RESISTANCE (BLOWS/FT.)	DRY DENSITY (P.C.F.)	MOISTURE CONTENT (%)
				SOIL CLASS (USCS)	ELEV. (MSL.) <u>540</u> DATE COMPLETED <u>4/6/95</u> EQUIPMENT <u>JD 555</u>			
MATERIAL DESCRIPTION								
0				SM/GM	TOPSOIL Loose to medium dense, moist, dark brown, Silty, fine to medium SAND with some coarse gravel			
2						GM	FRIARS FORMATION Very dense, damp, orangish brown to yellowish brown, Silty, fine to medium Sandy GRAVEL/COBBLE CONGLOMERATE; trace of clay; predominant clast size 3 inches to 4 inches; matrix supported; moderately to highly cemented -Clast size increases at 4 feet	
4								
6								
BOTTOM OF TRENCH AT 7 FEET								

Figure A-32, Log of Trench T 92

FRNC1

SAMPLE SYMBOLS	<input type="checkbox"/>	... SAMPLING UNSUCCESSFUL	<input type="checkbox"/>	... STANDARD PENETRATION TEST	<input type="checkbox"/>	... DRIVE SAMPLE (UNDISTURBED)
	<input checked="" type="checkbox"/>	... DISTURBED OR BAG SAMPLE	<input checked="" type="checkbox"/>	... CHUNK SAMPLE		... WATER TABLE OR SEEPAGE

NOTE: THE LOG OF SUBSURFACE CONDITIONS SHOWN HEREON APPLIES ONLY AT THE SPECIFIC BORING OR TRENCH LOCATION AND AT THE DATE INDICATED. IT IS NOT WARRANTED TO BE REPRESENTATIVE OF SUBSURFACE CONDITIONS AT OTHER LOCATIONS AND TIMES.

TRENCH T 93					PENETRATION RESISTANCE (BLOWS/FT.)	DRY DENSITY (P.C.F.)	MOISTURE CONTENT (%)
DEPTH IN FEET	SAMPLE NO.	LITHOLOGY	GROUNDWATER	SOIL CLASS (USCS)			
ELEV. (MSL.) <u>580</u> DATE COMPLETED <u>4/6/95</u>							
EQUIPMENT <u>JD 555</u>							
MATERIAL DESCRIPTION							
0				SM	ALLUVIUM Loose, moist, dark brown, Silty, fine to medium SAND with trace of coarse gravel Loose to medium dense, very moist to wet, dark reddish brown, Clayey, fine to medium SAND/fine to medium Sandy CLAY with few coarse gravel -Slight seepage at 2 feet Very stiff, moist, orangish brown, fine to medium Sandy CLAY with 3 inch to 4 inch diameter cobbles		
2				SC/CL			
4				GC			
6				GM			
FRIARS FORMATION							
Very dense, damp, orangish brown to grayish brown, Silty, fine to medium Sandy COBBLE CONGLOMERATE; trace of clay; predominant clast size 3 inches to 6 inches with clasts up to 12 inches; moderately to highly cemented							
BOTTOM OF TRENCH AT 7.5 FEET							

Figure A-33, Log of Trench T 93

FRNC1

SAMPLE SYMBOLS	... SAMPLING UNSUCCESSFUL	... STANDARD PENETRATION TEST	... DRIVE SAMPLE (UNDISTURBED)
	... DISTURBED OR BAG SAMPLE	... CHUNK SAMPLE	... WATER TABLE OR SEEPAGE

NOTE: THE LOG OF SUBSURFACE CONDITIONS SHOWN HEREON APPLIES ONLY AT THE SPECIFIC BORING OR TRENCH LOCATION AND AT THE DATE INDICATED. IT IS NOT WARRANTED TO BE REPRESENTATIVE OF SUBSURFACE CONDITIONS AT OTHER LOCATIONS AND TIMES.



DEPTH IN FEET	SAMPLE NO.	LITHOLOGY	GROUNDWATER	TRENCH T 94		PENETRATION RESISTANCE (BLOWS/FT.)	DRY DENSITY (P.C.F.)	MOISTURE CONTENT (%)
				SOIL CLASS (USCS)	ELEV. (MSL.) <u>618</u> DATE COMPLETED <u>4/6/95</u> EQUIPMENT <u>JD 555</u>			
MATERIAL DESCRIPTION								
0				SC/CL	TOPSOIL Loose to medium dense, very moist to wet, brown, Clayey, fine to medium SAND/fine to medium Sandy CLAY			
2				CL	WEATHERED FRIARS FORMATION Stiff to very stiff, moist, olive-green to olive-brown, fine to medium Sandy CLAY with few 3 inch diameter cobbles			
4				CL	FRIARS FORMATION Very stiff, damp, olive-green to olive-brown, Silty CLAYSTONE; fractured and blocky appearance with black and orange oxide staining along fractures			
6								
BOTTOM OF TRENCH AT 7 FEET								

Figure A-34, Log of Trench T 94

FRNC1

SAMPLE SYMBOLS	<input type="checkbox"/> ... SAMPLING UNSUCCESSFUL	<input type="checkbox"/> ... STANDARD PENETRATION TEST	<input type="checkbox"/> ... DRIVE SAMPLE (UNDISTURBED)
	<input checked="" type="checkbox"/> ... DISTURBED OR BAG SAMPLE	<input type="checkbox"/> ... CHUNK SAMPLE	<input type="checkbox"/> ... WATER TABLE OR SEEPAGE

NOTE: THE LOG OF SUBSURFACE CONDITIONS SHOWN HEREON APPLIES ONLY AT THE SPECIFIC BORING OR TRENCH LOCATION AND AT THE DATE INDICATED. IT IS NOT WARRANTED TO BE REPRESENTATIVE OF SUBSURFACE CONDITIONS AT OTHER LOCATIONS AND TIMES.



DEPTH IN FEET	SAMPLE NO.	LITHOLOGY	GROUNDWATER	TRENCH T 95		PENETRATION RESISTANCE (BLOWS/FT.)	DRY DENSITY (P.C.F.)	MOISTURE CONTENT (%)
				SOIL CLASS (USCS)	ELEV. (MSL.) <u>498</u> DATE COMPLETED <u>4/6/95</u> EQUIPMENT <u>JD 555</u>			
MATERIAL DESCRIPTION								
0				SM/SC	TOPSOIL Loose, damp to moist, dark brown, Silty/Clayey, fine to medium			
2				CL	SAND Stiff to very stiff, moist, dark reddish brown, fine to medium			
4					SANDY CLAY Sandy Clay; occasional 3 inch diameter cobble			
					GRANITIC ROCK Moderately weathered, gray mottled with reddish brown, strong, -Becomes slightly weathered, gray, and strong to very strong at 3 feet -Excavates to: silty, fine to coarse sand with trace of clay with approximately 25 percent 1-inch to 2-inch angular rock fragments			
BOTTOM OF TRENCH AT 5 FEET								

Figure A-35, Log of Trench T 95

FRNC1

SAMPLE SYMBOLS	<input type="checkbox"/> ... SAMPLING UNSUCCESSFUL	<input type="checkbox"/> ... STANDARD PENETRATION TEST	<input type="checkbox"/> ... DRIVE SAMPLE (UNDISTURBED)
	<input checked="" type="checkbox"/> ... DISTURBED OR BAG SAMPLE	<input type="checkbox"/> ... CHUNK SAMPLE	<input type="checkbox"/> ... WATER TABLE OR SEEPAGE

NOTE: THE LOG OF SUBSURFACE CONDITIONS SHOWN HEREON APPLIES ONLY AT THE SPECIFIC BORING OR TRENCH LOCATION AND AT THE DATE INDICATED. IT IS NOT WARRANTED TO BE REPRESENTATIVE OF SUBSURFACE CONDITIONS AT OTHER LOCATIONS AND TIMES.



DEPTH IN FEET	SAMPLE NO.	LITHOLOGY	GROUNDWATER	SOIL CLASS (USCS)	TRENCH T 96		PENETRATION RESISTANCE (BLOWS/FT.)	DRY DENSITY (P.C.F.)	MOISTURE CONTENT (%)
					ELEV. (MSL.) <u>516</u>	DATE COMPLETED <u>4/6/95</u>			
					EQUIPMENT <u>JD 555</u>				
MATERIAL DESCRIPTION									
0									
2				CL	ALLUVIUM Stiff, moist, dark reddish brown, fine to medium Sandy CLAY with few 3 inch diameter cobble				
4					GRANITIC ROCK Highly weathered, yellowish to orangish brown, weak, GRANITIC ROCK -Becomes moderately weathered, gray, and moderately strong at 7 feet -Excavates to: silty, fine to coarse sand with some 2 inch rock fragments				
8					BOTTOM OF TRENCH AT 8 FEET				

Figure A-36, Log of Trench T 96

FRNC1

SAMPLE SYMBOLS	<input type="checkbox"/> ... SAMPLING UNSUCCESSFUL	<input type="checkbox"/> ... STANDARD PENETRATION TEST	<input type="checkbox"/> ... DRIVE SAMPLE (UNDISTURBED)
	<input checked="" type="checkbox"/> ... DISTURBED OR BAG SAMPLE	<input checked="" type="checkbox"/> ... CHUNK SAMPLE	<input checked="" type="checkbox"/> ... WATER TABLE OR SEEPAGE

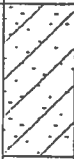
NOTE: THE LOG OF SUBSURFACE CONDITIONS SHOWN HEREON APPLIES ONLY AT THE SPECIFIC BORING OR TRENCH LOCATION AND AT THE DATE INDICATED. IT IS NOT WARRANTED TO BE REPRESENTATIVE OF SUBSURFACE CONDITIONS AT OTHER LOCATIONS AND TIMES.





DEPTH IN FEET	SAMPLE NO.	LITHOLOGY	GROUNDWATER	SOIL CLASS (USCS)	TRENCH T 97		PENETRATION RESISTANCE (BLOWS/FT.)	DRY DENSITY (P.C.F.)	MOISTURE CONTENT (%)
					ELEV. (MSL.) <u>552</u>	DATE COMPLETED <u>4/6/95</u>			
					EQUIPMENT <u>JD 555</u>				
MATERIAL DESCRIPTION									
0				SP/GP	ALLUVIUM Loose, very moist, dark brown, Gravelly, fine to coarse SAND with a trace of clay -Moderate seepage and slight caving below 1 foot				
2									
4									
6				SC/CL	FRIARS FORMATION Dense, damp to moist, olive-gray, Clayey, fine SANDSTONE/fine Sandy CLAYSTONE; moderately cemented				
8									
10									
12		BOTTOM OF TRENCH AT 13 FEET TRENCH LOGGED FROM SURFACE							

Figure A-37, Log of Trench T 97

FRNC1

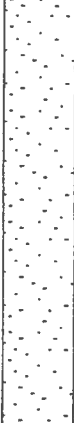
SAMPLE SYMBOLS	<input type="checkbox"/> ... SAMPLING UNSUCCESSFUL	<input type="checkbox"/> ... STANDARD PENETRATION TEST	<input type="checkbox"/> ... DRIVE SAMPLE (UNDISTURBED)
	<input checked="" type="checkbox"/> ... DISTURBED OR BAG SAMPLE	<input type="checkbox"/> ... CHUNK SAMPLE	 ... WATER TABLE OR SEEPAGE

NOTE: THE LOG OF SUBSURFACE CONDITIONS SHOWN HEREON APPLIES ONLY AT THE SPECIFIC BORING OR TRENCH LOCATION AND AT THE DATE INDICATED. IT IS NOT WARRANTED TO BE REPRESENTATIVE OF SUBSURFACE CONDITIONS AT OTHER LOCATIONS AND TIMES.

DEPTH IN FEET	SAMPLE NO.	LITHOLOGY	GROUNDWATER	SOIL CLASS (USCS)	TRENCH T 98		PENETRATION RESISTANCE (BLOWS/FT.)	DRY DENSITY (P.C.F.)	MOISTURE CONTENT (%)
					ELEV. (MSL.) 585	DATE COMPLETED 4/6/95			
					EQUIPMENT				
					JD 555				
MATERIAL DESCRIPTION									
0				SC/GC	ALLUVIUM				
2					Loose to medium dense, moist to very moist, dark brown, Clayey, fine to medium SAND with coarse gravel -Slight seepage from 1 foot to 2 feet				
4				GM	FRIARS FORMATION				
					Very dense, damp, light yellowish brown, Silty, fine to medium Sandy COBBLE CONGLOMERATE; predominant clast size 3 inch to 4 inch with clasts up to 10 inch; clast supported; moderately cemented				
					BOTTOM OF TRENCH AT 5 FEET				

Figure A-38, Log of Trench T 98

FRNC1

SAMPLE SYMBOLS		... SAMPLING UNSUCCESSFUL		... STANDARD PENETRATION TEST		... DRIVE SAMPLE (UNDISTURBED)
		... DISTURBED OR BAG SAMPLE		... CHUNK SAMPLE		... WATER TABLE OR SEEPAGE

NOTE: THE LOG OF SUBSURFACE CONDITIONS SHOWN HEREON APPLIES ONLY AT THE SPECIFIC BORING OR TRENCH LOCATION AND AT THE DATE INDICATED. IT IS NOT WARRANTED TO BE REPRESENTATIVE OF SUBSURFACE CONDITIONS AT OTHER LOCATIONS AND TIMES.



DEPTH IN FEET	SAMPLE NO.	LITHOLOGY	GROUNDWATER	SOIL CLASS (USCS)	TRENCH T 99		PENETRATION RESISTANCE (BLOWS/FT.)	DRY DENSITY (P.C.F.)	MOISTURE CONTENT (%)
					ELEV. (MSL.) 628	DATE COMPLETED 4/6/95			
					EQUIPMENT JD 555				
MATERIAL DESCRIPTION									
0									
2				CL	ALLUVIUM Soft to stiff, moist, dark brown, fine to medium Sandy CLAY with few 3 inch diameter cobbles				
4				SC/GC					
6				SM	FRIARS FORMATION Medium dense to dense, damp to moist, yellowish brown, Clayey, fine to medium SANDSTONE with cobble				
					Dense to very dense, damp, yellowish brown, Silty, fine to medium SANDSTONE; slightly cemented				
					BOTTOM OF TRENCH AT 7 FEET				

Figure A-39, Log of Trench T 99

FRNC1

SAMPLE SYMBOLS	 ... SAMPLING UNSUCCESSFUL	 ... STANDARD PENETRATION TEST	 ... DRIVE SAMPLE (UNDISTURBED)
	 ... DISTURBED OR BAG SAMPLE	 ... CHUNK SAMPLE	 ... WATER TABLE OR SEEPAGE

NOTE: THE LOG OF SUBSURFACE CONDITIONS SHOWN HEREON APPLIES ONLY AT THE SPECIFIC BORING OR TRENCH LOCATION AND AT THE DATE INDICATED. IT IS NOT WARRANTED TO BE REPRESENTATIVE OF SUBSURFACE CONDITIONS AT OTHER LOCATIONS AND TIMES.

DEPTH IN FEET	SAMPLE NO.	LITHOLOGY	GROUNDWATER	SOIL CLASS (USCS)	TRENCH T100		PENETRATION RESISTANCE (BLOWS/FT.)	DRY DENSITY (P.C.F.)	MOISTURE CONTENT (%)
					ELEV. (MSL.) <u>810</u>	DATE COMPLETED <u>4/10/95</u>			
					EQUIPMENT <u>JD 555</u>				
MATERIAL DESCRIPTION									
0				SM/GM	TOPSOIL Loose to medium dense, damp to moist, brown, Silty, fine to medium SAND with 3 inch to 5 inch diameter cobble and a trace of clay				
2				SM					
4				SM/GM	STADIUM CONGLOMERATE Dense, damp, orangish brown, Silty, fine to medium SANDSTONE; slightly cemented				
6				SC	Dense to very dense, damp, orangish brown, Silty, fine to medium sandy COBBLE CONGLOMERATE; trace of clay; predominant clast size 3 inch with maximum up to 8 inch Dense to very dense, damp, grayish brown to orangish brown, Clayey, fine to medium SAND				
					BOTTOM OF TRENCH AT 6 FEET				

Figure A-40, Log of Trench T100

FRNC1

SAMPLE SYMBOLS	<input type="checkbox"/> ... SAMPLING UNSUCCESSFUL	<input checked="" type="checkbox"/> ... STANDARD PENETRATION TEST	<input checked="" type="checkbox"/> ... DRIVE SAMPLE (UNDISTURBED)
	<input checked="" type="checkbox"/> ... DISTURBED OR BAG SAMPLE	<input checked="" type="checkbox"/> ... CHUNK SAMPLE	<input checked="" type="checkbox"/> ... WATER TABLE OR SEEPAGE

NOTE: THE LOG OF SUBSURFACE CONDITIONS SHOWN HEREON APPLIES ONLY AT THE SPECIFIC BORING OR TRENCH LOCATION AND AT THE DATE INDICATED. IT IS NOT WARRANTED TO BE REPRESENTATIVE OF SUBSURFACE CONDITIONS AT OTHER LOCATIONS AND TIMES.

DEPTH IN FEET	SAMPLE NO.	LITHOLOGY	GROUNDWATER	TRENCH T101		PENETRATION RESISTANCE (BLOWS/FT.)	DRY DENSITY (P.C.F.)	MOISTURE CONTENT (%)	
				ELEV. (MSL.) <u>635</u>	DATE COMPLETED <u>4/10/95</u>				
				SOIL CLASS (USCS)	EQUIPMENT <u>JD 555</u>				
MATERIAL DESCRIPTION									
0		[Diagonal Hatching]		SC/GC	ALLUVIUM Loose to medium dense, moist, dark brown, Clayey, fine to medium SAND/fine to medium Sandy CLAY with some coarse gravels and 3 inch diameter cobbles				
2									
4		[Diagonal Hatching]		CL/ML	LANDSLIDE DEBRIS Soft to stiff, moist, olive-brown, Silty CLAY/Clayey SILT; variegated and punky appearance; olive-green siltstone/claystone fragments in a clay matrix; approximately 25 percent calcium carbonate -Lense of hard, olive-brown claystone from 11 to 12 feet				
6									
8									
10									
12									
14									
BOTTOM OF TRENCH AT 15 FEET TRENCH LOGGED FROM SURFACE BELOW 9 FEET									

Figure A-41, Log of Trench T101

FRNC1

SAMPLE SYMBOLS	<input type="checkbox"/>	... SAMPLING UNSUCCESSFUL	<input type="checkbox"/>	... STANDARD PENETRATION TEST	<input type="checkbox"/>	... DRIVE SAMPLE (UNDISTURBED)
	<input checked="" type="checkbox"/>	... DISTURBED OR BAG SAMPLE	<input type="checkbox"/>	... CHUNK SAMPLE	<input type="checkbox"/>	... WATER TABLE OR SEEPAGE

NOTE: THE LOG OF SUBSURFACE CONDITIONS SHOWN HEREON APPLIES ONLY AT THE SPECIFIC BORING OR TRENCH LOCATION AND AT THE DATE INDICATED. IT IS NOT WARRANTED TO BE REPRESENTATIVE OF SUBSURFACE CONDITIONS AT OTHER LOCATIONS AND TIMES.

PROJECT NO. 05254-52-02

DEPTH IN FEET	SAMPLE NO.	LITHOLOGY	GROUNDWATER	SOIL CLASS (USCS)	TRENCH T102		PENETRATION RESISTANCE (BLOWS/FT.)	DRY DENSITY (P.C.F.)	MOISTURE CONTENT (%)
					ELEV. (MSL.) 750	DATE COMPLETED 4/10/95			
					EQUIPMENT JD 555				
MATERIAL DESCRIPTION									
0				SM/SC	TOPSOIL Loose, moist, dark brown, Silty/Clayey, fine to medium SAND				
2				CL	Stiff, moist, dark orangish brown, fine to medium Sandy CLAY with few coarse gravels to small cobbles				
4				GC	STADIUM CONGLOMERATE Dense, damp, orangish brown, Clayey, fine to medium Sandy COBBLE CONGLOMERATE; predominant clast size 3 inch to 4 inch; slightly cemented; clast supported -Lense of clayey, fine to medium sandstone from 4 to 5.5 feet -Becomes very dense, moderately cemented at 5.5 feet				
6					BOTTOM OF TRENCH AT 6 FEET				

Figure A-42, Log of Trench T102

FRNC1

SAMPLE SYMBOLS		... SAMPLING UNSUCCESSFUL		... STANDARD PENETRATION TEST		... DRIVE SAMPLE (UNDISTURBED)
		... DISTURBED OR BAG SAMPLE		... CHUNK SAMPLE		... WATER TABLE OR SEEPAGE

NOTE: THE LOG OF SUBSURFACE CONDITIONS SHOWN HEREON APPLIES ONLY AT THE SPECIFIC BORING OR TRENCH LOCATION AND AT THE DATE INDICATED. IT IS NOT WARRANTED TO BE REPRESENTATIVE OF SUBSURFACE CONDITIONS AT OTHER LOCATIONS AND TIMES.

DEPTH IN FEET	SAMPLE NO.	LITHOLOGY	GROUNDWATER	TRENCH T103		PENETRATION RESISTANCE (BLOWS/FT.)	DRY DENSITY (P.C.F.)	MOISTURE CONTENT (%)
				ELEV. (MSL.) <u>585</u>	DATE COMPLETED <u>4/10/95</u>			
					EQUIPMENT <u>JD 555</u>			
MATERIAL DESCRIPTION								
0				CL	<p>COLLUVIUM (GRABEN) Stiff, moist, dark brown, fine to medium Sandy CLAY with few 3 inch to 6 inch diameter cobbles</p> <p>-Cobble content increases at 6 feet</p> <p>-Lense of olive-green, silty clay/clayey silt with cobble from 7 to 8 feet</p> <p>-Becomes dark brown, fine to medium sandy clay at 8 feet</p>			
2								
4								
6								
8								
10								
12				CL	<p>LANDSLIDE DEBRIS Stiff, moist, olive-brown mottled with orange, fine to medium Sandy CLAY; punky appearance; -Green, angular claystone fragments suspended in soft clay matrix at 12 feet; -14 inch boulder at 12 feet</p>			
14								
BOTTOM OF TRENCH AT 15 FEET								

Figure A-43, Log of Trench T103

FRNC1

SAMPLE SYMBOLS	... SAMPLING UNSUCCESSFUL	... STANDARD PENETRATION TEST	... DRIVE SAMPLE (UNDISTURBED)
	... DISTURBED OR BAG SAMPLE	... CHUNK SAMPLE	... WATER TABLE OR SEEPAGE

NOTE: THE LOG OF SUBSURFACE CONDITIONS SHOWN HEREON APPLIES ONLY AT THE SPECIFIC BORING OR TRENCH LOCATION AND AT THE DATE INDICATED. IT IS NOT WARRANTED TO BE REPRESENTATIVE OF SUBSURFACE CONDITIONS AT OTHER LOCATIONS AND TIMES.

PROJECT NO. 05254-52-02

DEPTH IN FEET	SAMPLE NO.	LITHOLOGY	GROUNDWATER	TRENCH T104		PENETRATION RESISTANCE (BLOWS/FT.)	DRY DENSITY (P.C.F.)	MOISTURE CONTENT (%)			
				ELEV. (MSL.) <u>600</u>	DATE COMPLETED <u>4/10/95</u>						
				EQUIPMENT <u>JD 555</u>							
MATERIAL DESCRIPTION											
0				CL/SC/ GC	COLLUVIUM (GRABEN) Soft/loose, moist, orangish brown to yellowish brown, fine to medium Sandy CLAY/Clayey, fine to medium SAND; abundant cobbles/gravels and mixtures of silty, fine to medium sand and clayey silt						
2											
4											
6											
8											
10											
12											
BOTTOM OF TRENCH AT 12 FEET											

Figure A-44, Log of Trench T104

FRNC1

SAMPLE SYMBOLS	<input type="checkbox"/> ... SAMPLING UNSUCCESSFUL	<input type="checkbox"/> ... STANDARD PENETRATION TEST	<input type="checkbox"/> ... DRIVE SAMPLE (UNDISTURBED)
	<input checked="" type="checkbox"/> ... DISTURBED OR BAG SAMPLE	<input type="checkbox"/> ... CHUNK SAMPLE	<input type="checkbox"/> ... WATER TABLE OR SEEPAGE

NOTE: THE LOG OF SUBSURFACE CONDITIONS SHOWN HEREON APPLIES ONLY AT THE SPECIFIC BORING OR TRENCH LOCATION AND AT THE DATE INDICATED. IT IS NOT WARRANTED TO BE REPRESENTATIVE OF SUBSURFACE CONDITIONS AT OTHER LOCATIONS AND TIMES.

PROJECT NO. 05254-52-02

DEPTH IN FEET	SAMPLE NO.	LITHOLOGY	GROUNDWATER	SOIL CLASS (USCS)	TRENCH T105		PENETRATION RESISTANCE (BLOWS/FT.)	DRY DENSITY (P.C.F.)	MOISTURE CONTENT (%)	
					ELEV. (MSL.) <u>585</u>	DATE COMPLETED <u>4/10/95</u>				
					EQUIPMENT <u>JD 555</u>					
MATERIAL DESCRIPTION										
0				CL/GC	COLLUVIUM (GRABEN) Soft to medium stiff, moist, dark brown, fine to medium Sandy CLAY with coarse gravel and small cobble					
2										
4					ML	Medium dense, moist, olive-brown, Clayey SILT				
6				SC	LANDSLIDE DEBRIS (BLOCK ?) Dense to very dense, damp, olive-brown to reddish brown, Clayey, fine SANDSTONE					
8										
10						-Becomes light brown, silty, fine sandstone at 10 feet				
12						-3 inch to 4 inch diameter cobbles at 13 feet				
14					BOTTOM OF TRENCH AT 14 FEET TRENCH LOGGED FROM SURFACE BELOW 7 FEET					

Figure A-45, Log of Trench T105

FRNC1

SAMPLE SYMBOLS	<input type="checkbox"/> ... SAMPLING UNSUCCESSFUL	<input type="checkbox"/> ... STANDARD PENETRATION TEST	<input checked="" type="checkbox"/> ... DRIVE SAMPLE (UNDISTURBED)
	<input checked="" type="checkbox"/> ... DISTURBED OR BAG SAMPLE	<input checked="" type="checkbox"/> ... CHUNK SAMPLE	<input checked="" type="checkbox"/> ... WATER TABLE OR SEEPAGE

NOTE: THE LOG OF SUBSURFACE CONDITIONS SHOWN HEREON APPLIES ONLY AT THE SPECIFIC BORING OR TRENCH LOCATION AND AT THE DATE INDICATED. IT IS NOT WARRANTED TO BE REPRESENTATIVE OF SUBSURFACE CONDITIONS AT OTHER LOCATIONS AND TIMES.

PROJECT NO. 05254-52-02

DEPTH IN FEET	SAMPLE NO.	LITHOLOGY	GROUNDWATER	TRENCH T106		PENETRATION RESISTANCE (BLOWS/FT.)	DRY DENSITY (P.C.F.)	MOISTURE CONTENT (%)
				SOIL CLASS (USCS)	ELEV. (MSL.) <u>612</u> DATE COMPLETED <u>4/10/95</u> EQUIPMENT <u>JD 555</u>			
MATERIAL DESCRIPTION								
0				CL/GC	TOPSOIL Stiff, moist, dark brown, fine to medium Sandy CLAY with some 3 inch to 6 inch diameter cobble			
2					GC	FRIARS FORMATION Dense, moist, orangish brown, Clayey, fine to medium Sandy COBBLE CONGLOMERATE; predominant clast size 5 inch to 6 inch with clasts up to 10 inch; slightly cemented; matrix supported -Becomes light brown, silty, fine to medium sandy gravel/cobble conglomerate at 5.5 feet; decrease in clast size and increase in cementation		
4								
6								
8								
BOTTOM OF TRENCH AT 8 FEET								

Figure A-46, Log of Trench T106

FRNC1

SAMPLE SYMBOLS	<input type="checkbox"/>	... SAMPLING UNSUCCESSFUL	<input type="checkbox"/>	... STANDARD PENETRATION TEST	<input type="checkbox"/>	... DRIVE SAMPLE (UNDISTURBED)
	<input checked="" type="checkbox"/>	... DISTURBED OR BAG SAMPLE	<input type="checkbox"/>	... CHUNK SAMPLE	<input type="checkbox"/>	... WATER TABLE OR SEEPAGE

NOTE: THE LOG OF SUBSURFACE CONDITIONS SHOWN HEREON APPLIES ONLY AT THE SPECIFIC BORING OR TRENCH LOCATION AND AT THE DATE INDICATED. IT IS NOT WARRANTED TO BE REPRESENTATIVE OF SUBSURFACE CONDITIONS AT OTHER LOCATIONS AND TIMES.





DEPTH IN FEET	SAMPLE NO.	LITHOLOGY	GROUNDWATER	SOIL CLASS (USCS)	TRENCH T107		PENETRATION RESISTANCE (BLOWS/FT.)	DRY DENSITY (P.C.F.)	MOISTURE CONTENT (%)
					ELEV. (MSL.) 620	DATE COMPLETED 4/10/95			
					EQUIPMENT JD 555				
MATERIAL DESCRIPTION									
0				CL/GC	TOPSOIL Soft to stiff, moist, dark brown, fine to medium Sandy CLAY with 3 inch to 4 inch diameter cobbles -Becomes stiff and grayish brown at 1.5 feet				
2				GM/GC	FRIARS FORMATION Dense, damp, yellowish brown to grayish brown, fine to medium Sandy GRAVEL/COBBLE CONGLOMERATE with Silty/Clayey MATRX; predominant clast size 3 inches to 4 inches with clasts up to 6 inches; moderately cemented; matrix supported				
4				SM	-Dense, damp, light brown, silty, fine to medium sandstone; few 4-inch to 6-inch cobble; moderately cemented				
6					BOTTOM OF TRENCH AT 7.5 FEET				

Figure A-47, Log of Trench T107

FRNC1

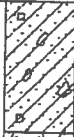
SAMPLE SYMBOLS	 ... SAMPLING UNSUCCESSFUL	 ... STANDARD PENETRATION TEST	 ... DRIVE SAMPLE (UNDISTURBED)
	 ... DISTURBED OR BAG SAMPLE	 ... CHUNK SAMPLE	 ... WATER TABLE OR SEEPAGE

NOTE: THE LOG OF SUBSURFACE CONDITIONS SHOWN HEREON APPLIES ONLY AT THE SPECIFIC BORING OR TRENCH LOCATION AND AT THE DATE INDICATED. IT IS NOT WARRANTED TO BE REPRESENTATIVE OF SUBSURFACE CONDITIONS AT OTHER LOCATIONS AND TIMES.

DEPTH IN FEET	SAMPLE NO.	LITHOLOGY	GROUNDWATER	TRENCH T108		PENETRATION RESISTANCE (BLOWS/FT.)	DRY DENSITY (P.C.F.)	MOISTURE CONTENT (%)
				SOIL CLASS (USCS)	ELEV. (MSL.) <u>582</u> DATE COMPLETED <u>4/10/95</u> EQUIPMENT <u>JD 555</u>			
MATERIAL DESCRIPTION								
0				SM	TOPSOIL Loose, damp to moist, dark brown, Silty, fine to medium SAND with few 3 inch to 4 inch diameter cobbles			
2				GC	FRIARS FORMATION Dense, damp to moist, orangish brown, Clayey, fine to medium Sandy COBBLE CONGLOMERATE with zones of clay within the matrix; predominant clast size 3 inches to 4 inches; moderately cemented -Matrix becomes silty, fine to medium sand at 5 feet -Decrease in cobble content at 5 feet			
4								
6								
BOTTOM OF TRENCH AT 7 FEET								

Figure A-48, Log of Trench T108

FRNC1

SAMPLE SYMBOLS	<input type="checkbox"/>	... SAMPLING UNSUCCESSFUL	<input type="checkbox"/>	... STANDARD PENETRATION TEST	<input type="checkbox"/>	... DRIVE SAMPLE (UNDISTURBED)
	<input checked="" type="checkbox"/>	... DISTURBED OR BAG SAMPLE	<input type="checkbox"/>	... CHUNK SAMPLE		... WATER TABLE OR SEEPAGE

NOTE: THE LOG OF SUBSURFACE CONDITIONS SHOWN HEREON APPLIES ONLY AT THE SPECIFIC BORING OR TRENCH LOCATION AND AT THE DATE INDICATED. IT IS NOT WARRANTED TO BE REPRESENTATIVE OF SUBSURFACE CONDITIONS AT OTHER LOCATIONS AND TIMES.









DEPTH IN FEET	SAMPLE NO.	LITHOLOGY	GROUNDWATER	SOIL CLASS (USCS)	TRENCH T109		PENETRATION RESISTANCE (BLOWS/FT.)	DRY DENSITY (P.C.F.)	MOISTURE CONTENT (%)
					ELEV. (MSL.) 565	DATE COMPLETED 4/10/95			
					EQUIPMENT				
					JD 555				
MATERIAL DESCRIPTION									
0									
2				SC/GC	COLLUVIUM (GRABEN) Medium dense, moist, dark brown, Clayey, fine to medium SAND with some coarse gravel and small cobble; occasional cobble up to 8 inches in diameter -Slight seepage at 2 feet -Increase in density at 2.5 feet				
4				SC	LANDSLIDE DEBRIS (BLOCK ?) Very dense, damp, olive-gray to olive-brown mottled with orange, Clayey, fine to medium SANDSTONE; slightly cemented -Becomes clayey, fine to medium sandy gravel/cobble conglomerate at 6 feet; moderately cemented				
6									
8									
BOTTOM OF TRENCH AT 8 FEET									

Figure A-49, Log of Trench T109

FRNC1

SAMPLE SYMBOLS	 ... SAMPLING UNSUCCESSFUL	 ... STANDARD PENETRATION TEST	 ... DRIVE SAMPLE (UNDISTURBED)
	 ... DISTURBED OR BAG SAMPLE	 ... CHUNK SAMPLE	 ... WATER TABLE OR SEEPAGE

NOTE: THE LOG OF SUBSURFACE CONDITIONS SHOWN HEREON APPLIES ONLY AT THE SPECIFIC BORING OR TRENCH LOCATION AND AT THE DATE INDICATED. IT IS NOT WARRANTED TO BE REPRESENTATIVE OF SUBSURFACE CONDITIONS AT OTHER LOCATIONS AND TIMES.

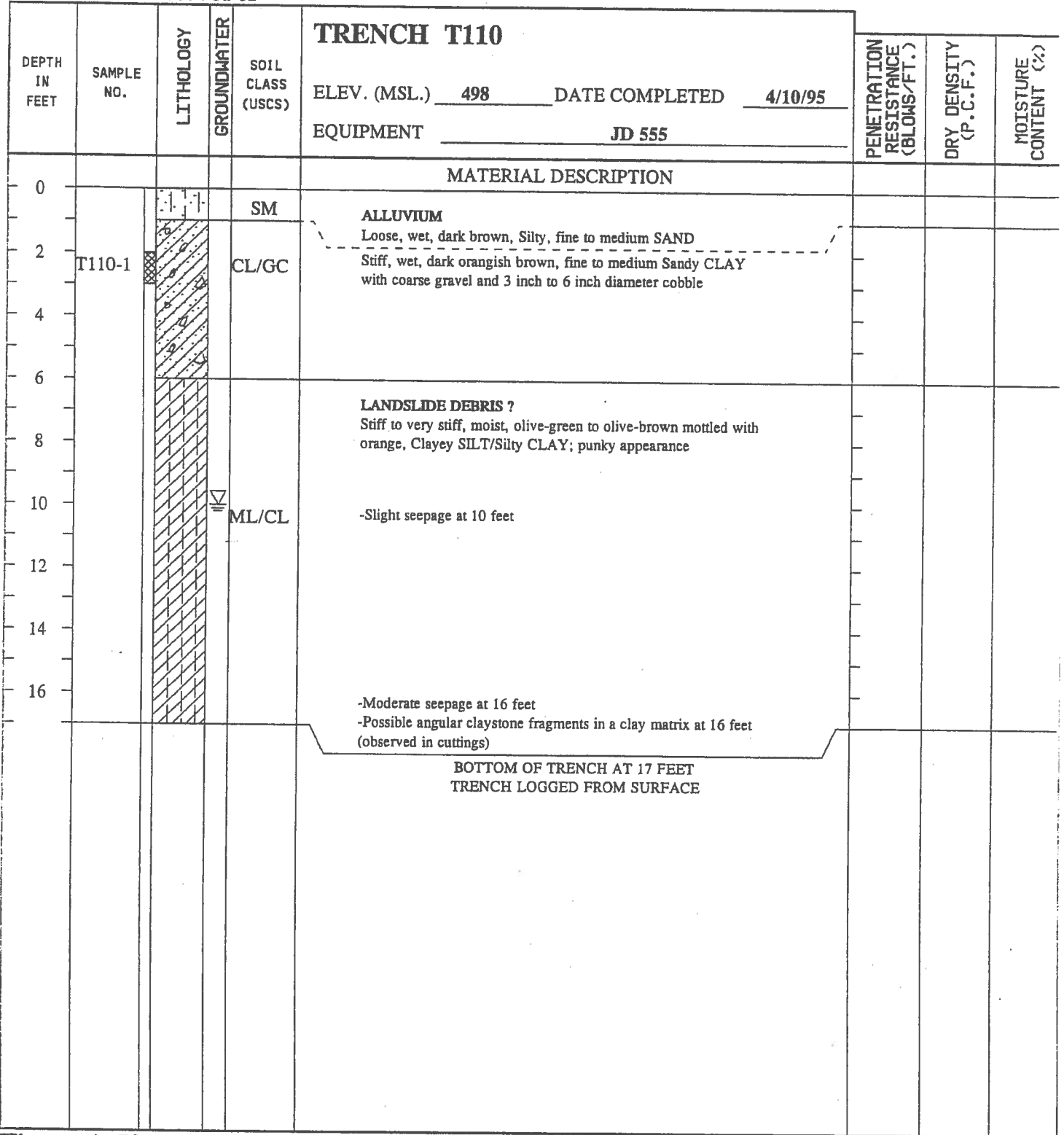

Figure A-50, Log of Trench T110

FRNC1

SAMPLE SYMBOLS	... SAMPLING UNSUCCESSFUL	... STANDARD PENETRATION TEST	... DRIVE SAMPLE (UNDISTURBED)
	... DISTURBED OR BAG SAMPLE	... CHUNK SAMPLE	... WATER TABLE OR SEEPAGE

NOTE: THE LOG OF SUBSURFACE CONDITIONS SHOWN HEREON APPLIES ONLY AT THE SPECIFIC BORING OR TRENCH LOCATION AND AT THE DATE INDICATED. IT IS NOT WARRANTED TO BE REPRESENTATIVE OF SUBSURFACE CONDITIONS AT OTHER LOCATIONS AND TIMES.

DEPTH IN FEET	SAMPLE NO.	LITHOLOGY	GROUNDWATER	SOIL CLASS (USCS)	TRENCH T111		PENETRATION RESISTANCE (BLOWS/FT.)	DRY DENSITY (P.C.F.)	MOISTURE CONTENT (%)
					ELEV. (MSL.) 480	DATE COMPLETED 4/11/95			
					EQUIPMENT JD 555				
MATERIAL DESCRIPTION									
0									
2	T112-1			SC/GC	ALLUVIUM Loose, moist, dark brown, Clayey, fine to medium SAND with coarse gravel and 4 inch to 6 inch diameter cobble; occasional 12 inch boulders -Matrix becomes wet, fine to medium, sandy clay at 3 feet -Moderate seepage from 3 to 4 feet				
4	T112-2			SM/SC					
6					GRANITIC ROCK Highly weathered, orangish brown, strong GRANITIC ROCK -Excavates to: Silty fine to medium SAND				
BOTTOM OF TRENCH AT 7 FEET TRENCH LOGGED FROM SURFACE									

Figure A-51, Log of Trench T111

FRNC1

SAMPLE SYMBOLS		... SAMPLING UNSUCCESSFUL		... STANDARD PENETRATION TEST		... DRIVE SAMPLE (UNDISTURBED)
		... DISTURBED OR BAG SAMPLE		... CHUNK SAMPLE		... WATER TABLE OR SEEPAGE

NOTE: THE LOG OF SUBSURFACE CONDITIONS SHOWN HEREON APPLIES ONLY AT THE SPECIFIC BORING OR TRENCH LOCATION AND AT THE DATE INDICATED. IT IS NOT WARRANTED TO BE REPRESENTATIVE OF SUBSURFACE CONDITIONS AT OTHER LOCATIONS AND TIMES.

PROJECT NO. 05254-52-02

DEPTH IN FEET	SAMPLE NO.	LITHOLOGY	GROUNDWATER	SOIL CLASS (USCS)	TRENCH T112		PENETRATION RESISTANCE (BLOWS/FT.)	DRY DENSITY (P.C.F.)	MOISTURE CONTENT (%)
					ELEV. (MSL.) 512	DATE COMPLETED 4/11/95			
					EQUIPMENT JD 555				
MATERIAL DESCRIPTION									
0		[Hatched Lithology Column]		CL	TOPSOIL Stiff, moist, dark brown, Silty CLAY				
2				ML	WEATHERED FRIARS FORMATION Soft to stiff, moist, olive-brown, Clayey SILT -Moderately weathered from 3 to 7 feet -Slight seepage at 5 feet				
4				CL	Stiff, moist, olive-green to olive-brown, Silty CLAYSTONE -Becomes moist to wet and olive-green at 7 feet				
6									
8									
10									
12				CL	FRIARS FORMATION Very stiff, damp to moist, olive-green, fine to medium Sandy CLAYSTONE -Density increases at 12 feet				
					BOTTOM OF TRENCH AT 13 FEET				

Figure A-52, Log of Trench T112

FRNC1

SAMPLE SYMBOLS	□ ... SAMPLING UNSUCCESSFUL	▣ ... STANDARD PENETRATION TEST	■ ... DRIVE SAMPLE (UNDISTURBED)
	⊠ ... DISTURBED OR BAG SAMPLE	▤ ... CHUNK SAMPLE	▽ ... WATER TABLE OR SEEPAGE

NOTE: THE LOG OF SUBSURFACE CONDITIONS SHOWN HEREON APPLIES ONLY AT THE SPECIFIC BORING OR TRENCH LOCATION AND AT THE DATE INDICATED. IT IS NOT WARRANTED TO BE REPRESENTATIVE OF SUBSURFACE CONDITIONS AT OTHER LOCATIONS AND TIMES.

DEPTH IN FEET	SAMPLE NO.	LITHOLOGY	GROUNDWATER	SOIL CLASS (USCS)	TRENCH T113		PENETRATION RESISTANCE (BLOWS/FT.)	DRY DENSITY (P.C.F.)	MOISTURE CONTENT (%)
					ELEV. (MSL.) 530	DATE COMPLETED 4/11/95			
					EQUIPMENT JD 555				
MATERIAL DESCRIPTION									
0				CL	TOPSOIL Soft, moist, dark brown, Silty CLAY				
2				ML	WEATHERED FRIARS FORMATION Soft, to stiff, moist, olive-brown, Clayey SILT -Moderately to highly weathered from 0.5 to 7 feet				
4				CL	Stiff, moist, olive-brown to olive-green, Silty CLAY -Approximately 50 percent calcium carbonate replacement from 3 to 5 feet -Becomes very stiff at 5 feet with approximately 10 to 20 percent calcium carbonate replacement -Slight to moderate seepage at 7 feet				
6									
8									
10									
12				CL	FRIARS FORMATION ? Stiff to very stiff, damp to moist, olive-green, Silty CLAYSTONE				
14									
					BOTTOM OF TRENCH AT 15 FEET TRENCH LOGGED FROM SURFACE BELOW 7 FEET				

Figure A-53, Log of Trench T113

FRNC1

SAMPLE SYMBOLS	<input type="checkbox"/> ... SAMPLING UNSUCCESSFUL	<input type="checkbox"/> ... STANDARD PENETRATION TEST	<input type="checkbox"/> ... DRIVE SAMPLE (UNDISTURBED)
	<input checked="" type="checkbox"/> ... DISTURBED OR BAG SAMPLE	<input type="checkbox"/> ... CHUNK SAMPLE	<input type="checkbox"/> ... WATER TABLE OR SEEPAGE

NOTE: THE LOG OF SUBSURFACE CONDITIONS SHOWN HEREON APPLIES ONLY AT THE SPECIFIC BORING OR TRENCH LOCATION AND AT THE DATE INDICATED. IT IS NOT WARRANTED TO BE REPRESENTATIVE OF SUBSURFACE CONDITIONS AT OTHER LOCATIONS AND TIMES.

DEPTH IN FEET	SAMPLE NO.	LITHOLOGY	GROUNDWATER	TRENCH T114		PENETRATION RESISTANCE (BLOWS/FT.)	DRY DENSITY (P.C.F.)	MOISTURE CONTENT (%)
				SOIL CLASS (USCS)	ELEV. (MSL.) <u>610</u> DATE COMPLETED <u>4/11/95</u> EQUIPMENT <u>JD 555</u>			
MATERIAL DESCRIPTION								
0								
2				SM/GM	ALLUVIUM Loose, very moist, dark brown, Silty, fine to medium SAND with 3 inch to 6 inch diameter cobbles and a trace of coarse sand; maximum clast size up to 12 inches -Moderate to heavy seepage at 3 feet			
4								
6				ML	-Boulders up to 18 inches in diameter at 6 feet			
8				SC	WEATHERED FRIARS FORMATION ? Soft, moist, olive-green to olive-brown, Silty CLAY/Clayey SILT FRIARS FORMATION Dense, damp, olive-green, Clayey, fine to medium SANDSTONE -Becomes very dense at 8 feet			
BOTTOM OF TRENCH AT 9 FEET								

Figure A-54, Log of Trench T114

FRNC1

SAMPLE SYMBOLS	□ ... SAMPLING UNSUCCESSFUL	▣ ... STANDARD PENETRATION TEST	■ ... DRIVE SAMPLE (UNDISTURBED)
	▨ ... DISTURBED OR BAG SAMPLE	▩ ... CHUNK SAMPLE	▽ ... WATER TABLE OR SEEPAGE

NOTE: THE LOG OF SUBSURFACE CONDITIONS SHOWN HEREON APPLIES ONLY AT THE SPECIFIC BORING OR TRENCH LOCATION AND AT THE DATE INDICATED. IT IS NOT WARRANTED TO BE REPRESENTATIVE OF SUBSURFACE CONDITIONS AT OTHER LOCATIONS AND TIMES.







DEPTH IN FEET	SAMPLE NO.	LITHOLOGY	GROUNDWATER	SOIL CLASS (USCS)	TRENCH T115		PENETRATION RESISTANCE (BLOWS/FT.)	DRY DENSITY (P.C.F.)	MOISTURE CONTENT (%)
					ELEV. (MSL.) <u>570</u>	DATE COMPLETED <u>4/11/95</u>			
					EQUIPMENT <u>JD 555</u>				
MATERIAL DESCRIPTION									
0									
2				CL	COLLUVIUM Stiff, moist, dark reddish brown, fine to medium Sandy CLAY -Density increases at 3 feet				
4				CL	Stiff to very stiff, moist, reddish brown, fine to coarse Sandy CLAY -Very strong, gray, 2-inch granitic rock fragments from 6 feet				
6									
8					GRANITIC ROCK Moderately to highly weathered, light orangish brown, moderately strong GRANITIC ROCK -Excavates to: Silty, fine to medium SAND with trace of clay				
10									
12									
BOTTOM OF TRENCH AT 13 FEET									

Figure A-55, Log of Trench T115

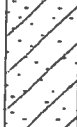
FRNC1

SAMPLE SYMBOLS	 ... SAMPLING UNSUCCESSFUL	 ... STANDARD PENETRATION TEST	 ... DRIVE SAMPLE (UNDISTURBED)
	 ... DISTURBED OR BAG SAMPLE	 ... CHUNK SAMPLE	 ... WATER TABLE OR SEEPAGE

NOTE: THE LOG OF SUBSURFACE CONDITIONS SHOWN HEREON APPLIES ONLY AT THE SPECIFIC BORING OR TRENCH LOCATION AND AT THE DATE INDICATED. IT IS NOT WARRANTED TO BE REPRESENTATIVE OF SUBSURFACE CONDITIONS AT OTHER LOCATIONS AND TIMES.

DEPTH IN FEET	SAMPLE NO.	LITHOLOGY	GROUNDWATER	SOIL CLASS (USCS)	TRENCH T116		PENETRATION RESISTANCE (BLOWS/FT.)	DRY DENSITY (P.C.F.)	MOISTURE CONTENT (%)
					ELEV. (MSL.) <u>565</u>	DATE COMPLETED <u>4/11/95</u>			
					EQUIPMENT <u>JD 555</u>				
MATERIAL DESCRIPTION									
0				SM	TOPSOIL Loose, damp, brown, Silty, fine to medium SAND; rootlets to 2 feet				
2					GRANITIC ROCK Completely weathered, dark reddish brown, weak, GRANITIC ROCK				
4					-Becomes moderately weathered, light orangish brown to grayish brown and strong at 6 feet -Slight seepage at 7 feet				
6									
8									
BOTTOM OF TRENCH AT 9 FEET									

Figure A-56, Log of Trench T116

FRNC1

SAMPLE SYMBOLS	<input type="checkbox"/>	... SAMPLING UNSUCCESSFUL	<input type="checkbox"/>	... STANDARD PENETRATION TEST	<input type="checkbox"/>	... DRIVE SAMPLE (UNDISTURBED)
	<input checked="" type="checkbox"/>	... DISTURBED OR BAG SAMPLE	<input type="checkbox"/>	... CHUNK SAMPLE		... WATER TABLE OR SEEPAGE

NOTE: THE LOG OF SUBSURFACE CONDITIONS SHOWN HEREON APPLIES ONLY AT THE SPECIFIC BORING OR TRENCH LOCATION AND AT THE DATE INDICATED. IT IS NOT WARRANTED TO BE REPRESENTATIVE OF SUBSURFACE CONDITIONS AT OTHER LOCATIONS AND TIMES.







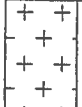

DEPTH IN FEET	SAMPLE NO.	LITHOLOGY	GROUNDWATER	SOIL CLASS (USCS)	TRENCH T117		PENETRATION RESISTANCE (BLOWS/FT.)	DRY DENSITY (P.C.F.)	MOISTURE CONTENT (%)
					ELEV. (MSL.) <u>540</u>	DATE COMPLETED <u>4/11/95</u>			
					EQUIPMENT <u>JD 555</u>				
MATERIAL DESCRIPTION									
0				SM	TOPSOIL				
2				SM/SC	Loose, moist, dark brown, Silty, fine to medium SAND Medium dense, very moist to wet, Silty to Clayey, fine to coarse SAND				
4					GRANITIC ROCK				
6					Moderately weathered, light olive-brown, weak to moderately strong GRANITIC ROCK -Excavates to: Silty, fine to medium SAND with a trace of clay				
BOTTOM OF TRENCH AT 6 FEET									

Figure A-57, Log of Trench T117

FRNC1

SAMPLE SYMBOLS	 ... SAMPLING UNSUCCESSFUL	 ... STANDARD PENETRATION TEST	 ... DRIVE SAMPLE (UNDISTURBED)
	 ... DISTURBED OR BAG SAMPLE	 ... CHUNK SAMPLE	 ... WATER TABLE OR SEEPAGE

NOTE: THE LOG OF SUBSURFACE CONDITIONS SHOWN HEREON APPLIES ONLY AT THE SPECIFIC BORING OR TRENCH LOCATION AND AT THE DATE INDICATED. IT IS NOT WARRANTED TO BE REPRESENTATIVE OF SUBSURFACE CONDITIONS AT OTHER LOCATIONS AND TIMES.

DEPTH IN FEET	SAMPLE NO.	LITHOLOGY	GROUNDWATER	SOIL CLASS (USCS)	TRENCH T118		PENETRATION RESISTANCE (BLOWS/FT.)	DRY DENSITY (P.C.F.)	MOISTURE CONTENT (%)
					ELEV. (MSL.) 535	DATE COMPLETED 4/11/95			
					EQUIPMENT JD 555				
MATERIAL DESCRIPTION									
0				CL	TOPSOIL Stiff, moist, dark orangish brown, fine to medium Sandy CLAY -Top 1 foot moderately weathered				
2					GRANITIC ROCK Slightly weathered, brownish gray, strong, GRANITIC ROCK -Excavates to: Silty, fine to coarse SAND				
BOTTOM OF TRENCH AT 3 FEET									

Figure A-58, Log of Trench T118

FRNC1

SAMPLE SYMBOLS		... SAMPLING UNSUCCESSFUL		... STANDARD PENETRATION TEST		... DRIVE SAMPLE (UNDISTURBED)
		... DISTURBED OR BAG SAMPLE		... CHUNK SAMPLE		... WATER TABLE OR SEEPAGE

NOTE: THE LOG OF SUBSURFACE CONDITIONS SHOWN HEREON APPLIES ONLY AT THE SPECIFIC BORING OR TRENCH LOCATION AND AT THE DATE INDICATED. IT IS NOT WARRANTED TO BE REPRESENTATIVE OF SUBSURFACE CONDITIONS AT OTHER LOCATIONS AND TIMES.



DEPTH IN FEET	SAMPLE NO.	LITHOLOGY	GROUNDWATER	SOIL CLASS (USCS)	TRENCH T119		PENETRATION RESISTANCE (BLOWS/FT.)	DRY DENSITY (P.C.F.)	MOISTURE CONTENT (%)
					ELEV. (MSL.) 515	DATE COMPLETED 4/11/95			
					EQUIPMENT				
					JD 555				
MATERIAL DESCRIPTION									
0				SM	TOPSOIL				
2				CL	Loose, moist, dark brown, Silty, fine to medium SAND with trace of clay and few coarse gravel				
4				GC	Medium stiff, moist, dark brown, Silty CLAY with trace of fine to medium sand and a few small cobbles				
6					FRIARS FORMATION				
					Dense to very dense, damp, yellowish brown, Clayey, fine to medium Sandy COBBLE CONGLOMERATE; predominant clast size 4 inches to 6 inches; slightly cemented; clast supported				
					-Slightly weathered from 2.5 to 3.5 feet				
BOTTOM OF TRENCH AT 7 FEET									

Figure A-59, Log of Trench T119

FRNC1

SAMPLE SYMBOLS	<input type="checkbox"/>	... SAMPLING UNSUCCESSFUL	<input type="checkbox"/>	... STANDARD PENETRATION TEST	<input checked="" type="checkbox"/>	... DRIVE SAMPLE (UNDISTURBED)
	<input checked="" type="checkbox"/>	... DISTURBED OR BAG SAMPLE	<input checked="" type="checkbox"/>	... CHUNK SAMPLE		... WATER TABLE OR SEEPAGE

NOTE: THE LOG OF SUBSURFACE CONDITIONS SHOWN HEREON APPLIES ONLY AT THE SPECIFIC BORING OR TRENCH LOCATION AND AT THE DATE INDICATED. IT IS NOT WARRANTED TO BE REPRESENTATIVE OF SUBSURFACE CONDITIONS AT OTHER LOCATIONS AND TIMES.



DEPTH IN FEET	SAMPLE NO.	LITHOLOGY	GROUNDWATER	TRENCH T120		PENETRATION RESISTANCE (BLOWS/FT.)	DRY DENSITY (P.C.F.)	MOISTURE CONTENT (%)
				ELEV. (MSL.) <u>578</u>	DATE COMPLETED <u>4/11/95</u>			
				SOIL CLASS (USCS)	EQUIPMENT <u>JD 555</u>			
MATERIAL DESCRIPTION								
0				SM/SC	TOPSOIL Loose, moist, dark brown, Silty, fine to medium SAND -Becomes soft, clayey, fine to medium sand at 1 foot			
2								
4				GRANITIC ROCK Highly weathered, grayish brown, weak, GRANITIC ROCK -Excavates to: Silty, fine to coarse SAND BOTTOM OF TRENCH AT 4 FEET				

Figure A-60, Log of Trench T120

FRNC1

SAMPLE SYMBOLS	<input type="checkbox"/> ... SAMPLING UNSUCCESSFUL	<input type="checkbox"/> ... STANDARD PENETRATION TEST	<input type="checkbox"/> ... DRIVE SAMPLE (UNDISTURBED)
	<input checked="" type="checkbox"/> ... DISTURBED OR BAG SAMPLE	<input checked="" type="checkbox"/> ... CHUNK SAMPLE	<input type="checkbox"/> ... WATER TABLE OR SEEPAGE

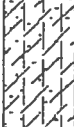
NOTE: THE LOG OF SUBSURFACE CONDITIONS SHOWN HEREON APPLIES ONLY AT THE SPECIFIC BORING OR TRENCH LOCATION AND AT THE DATE INDICATED. IT IS NOT WARRANTED TO BE REPRESENTATIVE OF SUBSURFACE CONDITIONS AT OTHER LOCATIONS AND TIMES.

DEPTH IN FEET	SAMPLE NO.	LITHOLOGY	GROUNDWATER	SOIL CLASS (USCS)	TRENCH T121		PENETRATION RESISTANCE (BLOWS/FT.)	DRY DENSITY (P.C.F.)	MOISTURE CONTENT (%)
					ELEV. (MSL.) <u>530</u>	DATE COMPLETED <u>4/12/95</u>			
					EQUIPMENT <u>JD 555</u>				
MATERIAL DESCRIPTION									
0									
2				SM	TOPSOIL Loose, very moist to wet, dark brown, Silty, fine to medium SAND				
4					GRANITIC ROCK Moderately weathered, orangish brown, weak to moderately weak, GRANITIC ROCK				
6					BOTTOM OF TRENCH AT 6 FEET				

Figure A-61, Log of Trench T121

FRNC1

SAMPLE SYMBOLS	<input type="checkbox"/>	... SAMPLING UNSUCCESSFUL	<input type="checkbox"/>	... STANDARD PENETRATION TEST	<input type="checkbox"/>	... DRIVE SAMPLE (UNDISTURBED)
	<input checked="" type="checkbox"/>	... DISTURBED OR BAG SAMPLE	<input type="checkbox"/>	... CHUNK SAMPLE	<input type="checkbox"/>	... WATER TABLE OR SEEPAGE

NOTE: THE LOG OF SUBSURFACE CONDITIONS SHOWN HEREON APPLIES ONLY AT THE SPECIFIC BORING OR TRENCH LOCATION AND AT THE DATE INDICATED. IT IS NOT WARRANTED TO BE REPRESENTATIVE OF SUBSURFACE CONDITIONS AT OTHER LOCATIONS AND TIMES.

DEPTH IN FEET	SAMPLE NO.	LITHOLOGY	GROUNDWATER	TRENCH T122		PENETRATION RESISTANCE (BLOWS/FT.)	DRY DENSITY (P.C.F.)	MOISTURE CONTENT (%)
				ELEV. (MSL.) <u>545</u>	DATE COMPLETED <u>4/12/95</u>			
				EQUIPMENT <u>JD 555</u>				
MATERIAL DESCRIPTION								
0		▨		CH/CL	TOPSOIL Stiff, moist, dark reddish brown, Silty CLAY with trace of fine to medium sand			
2		+			GRANITIC ROCK Slightly to moderately weathered, orangish brown to grayish brown, moderately strong, GRANITIC ROCK -Excavates to: Silty, fine to medium SAND with trace clay; 2 inch to 8 inch fragments			
					BOTTOM OF TRENCH AT 3.5 FEET			

Figure A-62, Log of Trench T122

FRNC1

SAMPLE SYMBOLS	□ ... SAMPLING UNSUCCESSFUL	▣ ... STANDARD PENETRATION TEST	■ ... DRIVE SAMPLE (UNDISTURBED)
	▩ ... DISTURBED OR BAG SAMPLE	▤ ... CHUNK SAMPLE	▼ ... WATER TABLE OR SEEPAGE

NOTE: THE LOG OF SUBSURFACE CONDITIONS SHOWN HEREON APPLIES ONLY AT THE SPECIFIC BORING OR TRENCH LOCATION AND AT THE DATE INDICATED. IT IS NOT WARRANTED TO BE REPRESENTATIVE OF SUBSURFACE CONDITIONS AT OTHER LOCATIONS AND TIMES.

DEPTH IN FEET	SAMPLE NO.	LITHOLOGY	GROUNDWATER	SOIL CLASS (USCS)	TRENCH T123		PENETRATION RESISTANCE (BLOWS/FT.)	DRY DENSITY (P.C.F.)	MOISTURE CONTENT (%)
					ELEV. (MSL.) 540	DATE COMPLETED 4/12/95			
					EQUIPMENT				
					JD 555				
MATERIAL DESCRIPTION									
0									
2				SM/GM	ALLUVIUM Loose, wet, dark brown, Silty, fine to coarse SAND with gravel and 3 inch to 4 inch diameter cobble -Heavy seepage from 1 foot to 2 feet				
4					GRANITIC ROCK Highly weathered, dark orangish brown, weak, GRANITIC ROCK -Becomes moderately weathered, orangish brown to gray, moderately strong at 3 feet				
					BOTTOM OF TRENCH AT 4 FEET TRENCH LOGGED FROM SURFACE				

Figure A-63, Log of Trench T123

FRNC1

SAMPLE SYMBOLS	<input type="checkbox"/>	... SAMPLING UNSUCCESSFUL	<input type="checkbox"/>	... STANDARD PENETRATION TEST	<input type="checkbox"/>	... DRIVE SAMPLE (UNDISTURBED)
	<input checked="" type="checkbox"/>	... DISTURBED OR BAG SAMPLE	<input type="checkbox"/>	... CHUNK SAMPLE	<input type="checkbox"/>	... WATER TABLE OR SEEPAGE

NOTE: THE LOG OF SUBSURFACE CONDITIONS SHOWN HEREON APPLIES ONLY AT THE SPECIFIC BORING OR TRENCH LOCATION AND AT THE DATE INDICATED. IT IS NOT WARRANTED TO BE REPRESENTATIVE OF SUBSURFACE CONDITIONS AT OTHER LOCATIONS AND TIMES.

DEPTH IN FEET	SAMPLE NO.	LITHOLOGY	GROUNDWATER	TRENCH T124		PENETRATION RESISTANCE (BLOWS/FT.)	DRY DENSITY (P.C.F.)	MOISTURE CONTENT (%)
				SOIL CLASS (USCS)	ELEV. (MSL.) <u>592</u> DATE COMPLETED <u>4/12/95</u> EQUIPMENT <u>JD 555</u>			
MATERIAL DESCRIPTION								
0				SM	TOPSOIL Loose, moist, dark reddish brown, Silty, fine to medium SAND			
2								
4					GRANITIC ROCK Highly weathered, light orangish brown, weak, GRANITIC ROCK; zones of differential weathering with highly weathered matrix surrounding granitic boulder; granitic boulder is fresh, orangish brown to orangish gray, and very strong BOTTOM OF TRENCH AT 4 FEET			

Figure A-64, Log of Trench T124

FRNC1

SAMPLE SYMBOLS	<input type="checkbox"/> ... SAMPLING UNSUCCESSFUL	<input type="checkbox"/> ... STANDARD PENETRATION TEST	<input type="checkbox"/> ... DRIVE SAMPLE (UNDISTURBED)
	<input checked="" type="checkbox"/> ... DISTURBED OR BAG SAMPLE	<input type="checkbox"/> ... CHUNK SAMPLE	<input type="checkbox"/> ... WATER TABLE OR SEEPAGE

NOTE: THE LOG OF SUBSURFACE CONDITIONS SHOWN HEREON APPLIES ONLY AT THE SPECIFIC BORING OR TRENCH LOCATION AND AT THE DATE INDICATED. IT IS NOT WARRANTED TO BE REPRESENTATIVE OF SUBSURFACE CONDITIONS AT OTHER LOCATIONS AND TIMES.

DEPTH IN FEET	SAMPLE NO.	LITHOLOGY	GROUNDWATER	TRENCH T125		PENETRATION RESISTANCE (BLOWS/FT.)	DRY DENSITY (P.C.F.)	MOISTURE CONTENT (%)
				ELEV. (MSL.) 590	DATE COMPLETED 4/12/95			
				EQUIPMENT JD 555				
MATERIAL DESCRIPTION								
0				SM/GM	ALLUVIUM Loose, wet, dark brown, Silty, fine to medium SAND with gravel and 3 inch to 6 inch diameter cobbles; trace of clay and coarse sand; maximum clast size up to 10 inches -Heavy seepage at 2 feet -Heavy caving below 2 feet			
2								
4								
6					GRANITIC ROCK Highly weathered, yellowish gray, weak, GRANITIC ROCK -Becomes moderately weathered, orangish brown, and moderately strong at 9 feet			
8								
10								
BOTTOM OF TRENCH AT 11 FEET TRENCH LOGGED FROM SURFACE								

Figure A-65, Log of Trench T125

FRNC1

SAMPLE SYMBOLS	<input type="checkbox"/> ... SAMPLING UNSUCCESSFUL	<input type="checkbox"/> ... STANDARD PENETRATION TEST	<input type="checkbox"/> ... DRIVE SAMPLE (UNDISTURBED)
	<input checked="" type="checkbox"/> ... DISTURBED OR BAG SAMPLE	<input type="checkbox"/> ... CHUNK SAMPLE	... WATER TABLE OR SEEPAGE

NOTE: THE LOG OF SUBSURFACE CONDITIONS SHOWN HEREON APPLIES ONLY AT THE SPECIFIC BORING OR TRENCH LOCATION AND AT THE DATE INDICATED. IT IS NOT WARRANTED TO BE REPRESENTATIVE OF SUBSURFACE CONDITIONS AT OTHER LOCATIONS AND TIMES.

DEPTH IN FEET	SAMPLE NO.	LITHOLOGY	GROUNDWATER	SOIL CLASS (USCS)	TRENCH T126		PENETRATION RESISTANCE (BLOWS/FT.)	DRY DENSITY (P.C.F.)	MOISTURE CONTENT (%)
					ELEV. (MSL.) <u>635</u>	DATE COMPLETED <u>4/12/95</u>			
					EQUIPMENT <u>JD 555</u>				
MATERIAL DESCRIPTION									
0				SM/GM	ALLUVIUM Loose, damp, brown, Silty, fine to medium SAND with 3 inch to 5 inch diameter cobbles -Subangular granitic rock fragments from 1 foot to 2 feet				
2									
4									
					GRANITIC ROCK Moderately weathered, orangish brown to yellowish brown, moderately strong, GRANITIC ROCK -Excavates to: Silty, fine to medium SAND BOTTOM OF TRENCH AT 5.5 FEET				

Figure A-66, Log of Trench T126

FRNC1

SAMPLE SYMBOLS	<input type="checkbox"/> ... SAMPLING UNSUCCESSFUL	<input type="checkbox"/> ... STANDARD PENETRATION TEST	<input checked="" type="checkbox"/> ... DRIVE SAMPLE (UNDISTURBED)
	<input checked="" type="checkbox"/> ... DISTURBED OR BAG SAMPLE	<input checked="" type="checkbox"/> ... CHUNK SAMPLE	<input checked="" type="checkbox"/> ... WATER TABLE OR SEEPAGE

NOTE: THE LOG OF SUBSURFACE CONDITIONS SHOWN HEREON APPLIES ONLY AT THE SPECIFIC BORING OR TRENCH LOCATION AND AT THE DATE INDICATED. IT IS NOT WARRANTED TO BE REPRESENTATIVE OF SUBSURFACE CONDITIONS AT OTHER LOCATIONS AND TIMES.

DEPTH IN FEET	SAMPLE NO.	LITHOLOGY	GROUNDWATER	TRENCH T127		PENETRATION RESISTANCE (BLOWS/FT.)	DRY DENSITY (P.C.F.)	MOISTURE CONTENT (%)
				ELEV. (MSL.) <u>605</u>	DATE COMPLETED <u>4/12/95</u>			
				SOIL CLASS (USCS)	EQUIPMENT <u>JD 555</u>			
MATERIAL DESCRIPTION								
0								
2				SM	TOPSOIL Loose, moist, dark reddish brown, Silty, fine to medium SAND with trace of clay			
4					GRANITIC ROCK Slightly to moderately weathered, orangish brown to gray, moderately strong, GRANITIC ROCK -Highly weathered from 3 to 4 feet -Excavates to Silty, fine to medium SAND with 1-inch to 2-inch subangular fragments BOTTOM OF TRENCH AT 4.5 FEET			

Figure A-67, Log of Trench T127

FRNC1

SAMPLE SYMBOLS	<input type="checkbox"/> ... SAMPLING UNSUCCESSFUL	<input type="checkbox"/> ... STANDARD PENETRATION TEST	<input checked="" type="checkbox"/> ... DRIVE SAMPLE (UNDISTURBED)
	<input checked="" type="checkbox"/> ... DISTURBED OR BAG SAMPLE	<input checked="" type="checkbox"/> ... CHUNK SAMPLE	<input checked="" type="checkbox"/> ... WATER TABLE OR SEEPAGE

NOTE: THE LOG OF SUBSURFACE CONDITIONS SHOWN HEREON APPLIES ONLY AT THE SPECIFIC BORING OR TRENCH LOCATION AND AT THE DATE INDICATED. IT IS NOT WARRANTED TO BE REPRESENTATIVE OF SUBSURFACE CONDITIONS AT OTHER LOCATIONS AND TIMES.







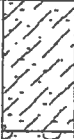

DEPTH IN FEET	SAMPLE NO.	LITHOLOGY	GROUNDWATER	TRENCH T128		PENETRATION RESISTANCE (BLOWS/FT.)	DRY DENSITY (P.C.F.)	MOISTURE CONTENT (%)
				SOIL CLASS (USCS)	ELEV. (MSL.) <u>535</u> DATE COMPLETED <u>4/12/95</u> EQUIPMENT <u>JD 555</u>			
MATERIAL DESCRIPTION								
0								
2				SC	TOPSOIL Loose, moist, dark reddish brown, Clayey, fine to medium SAND			
4				SC/GC	ALLUVIUM Medium dense, damp to moist, orangish brown, Clayey, fine to medium SAND with abundant cobble; granitic rock fragments			
6					GRANITIC ROCK Moderately weathered, orangish brown, weak to moderately strong, GRANITIC ROCK -Excavates to: Silty, fine to coarse SAND			
					BOTTOM OF TRENCH AT 6 FEET			

Figure A-68, Log of Trench T128

FRNC1

SAMPLE SYMBOLS		... SAMPLING UNSUCCESSFUL		... STANDARD PENETRATION TEST		... DRIVE SAMPLE (UNDISTURBED)
		... DISTURBED OR BAG SAMPLE		... CHUNK SAMPLE		... WATER TABLE OR SEEPAGE

NOTE: THE LOG OF SUBSURFACE CONDITIONS SHOWN HEREON APPLIES ONLY AT THE SPECIFIC BORING OR TRENCH LOCATION AND AT THE DATE INDICATED. IT IS NOT WARRANTED TO BE REPRESENTATIVE OF SUBSURFACE CONDITIONS AT OTHER LOCATIONS AND TIMES.

DEPTH IN FEET	SAMPLE NO.	LITHOLOGY	GROUNDWATER	TRENCH T129		PENETRATION RESISTANCE (BLOWS/FT.)	DRY DENSITY (P.C.F.)	MOISTURE CONTENT (%)	
				SOIL CLASS (USCS)	ELEV. (MSL.) <u>565</u> DATE COMPLETED <u>4/12/95</u> EQUIPMENT <u>JD 555</u>				
MATERIAL DESCRIPTION									
0				CL	COLLUVIUM (GRABEN) Stiff, moist, dark brown, fine to medium Sandy CLAY with few 3 inch to 5 inch diameter cobbles				
2					CL/GC	Very stiff to hard, damp to moist, yellowish brown to olive-brown, fine to medium Sandy CLAY with gravel and 3 inch to 4 inch diameter cobbles; maximum clast size up to 12 inches			
4									
6									
8									
10									
12				CL	LANDSLIDE DEBRIS Soft, moist, olive-gray, Silty CLAY with some fine sand; punky and disturbed appearance				
BOTTOM OF TRENCH AT 12.5 FEET									

Figure A-69, Log of Trench T129

FRNC1

SAMPLE SYMBOLS	<input type="checkbox"/> ... SAMPLING UNSUCCESSFUL	<input type="checkbox"/> ... STANDARD PENETRATION TEST	<input type="checkbox"/> ... DRIVE SAMPLE (UNDISTURBED)
	<input checked="" type="checkbox"/> ... DISTURBED OR BAG SAMPLE	<input type="checkbox"/> ... CHUNK SAMPLE	<input type="checkbox"/> ... WATER TABLE OR SEEPAGE

NOTE: THE LOG OF SUBSURFACE CONDITIONS SHOWN HEREON APPLIES ONLY AT THE SPECIFIC BORING OR TRENCH LOCATION AND AT THE DATE INDICATED. IT IS NOT WARRANTED TO BE REPRESENTATIVE OF SUBSURFACE CONDITIONS AT OTHER LOCATIONS AND TIMES.

PROJECT NO. 05254-52-02

DEPTH IN FEET	SAMPLE NO.	LITHOLOGY	GROUNDWATER	SOIL CLASS (USCS)	TRENCH T130		PENETRATION RESISTANCE (BLOWS/FT.)	DRY DENSITY (P.C.F.)	MOISTURE CONTENT (%)
					ELEV. (MSL.)	DATE COMPLETED			
					ELEV. (MSL.)	570	DATE COMPLETED	4/12/95	
					EQUIPMENT	JD 555			
MATERIAL DESCRIPTION									
0				SM	COLLUVIUM (GRABEN) Loose, moist, dark brown, Silty, fine to medium SAND with trace of clay Stiff, moist, dark brown, fine to medium Sandy CLAY with few gravel and 3 inch diameter cobbles -Increase in cobble size and percent from 4 to 6 feet -Becomes orangish brown to grayish brown at 5 feet				
2				CL/GC					
4									
6									
8									
BOTTOM OF TRENCH AT 9 FEET									

Figure A-70, Log of Trench T130

FRNC1

SAMPLE SYMBOLS	<input type="checkbox"/>	... SAMPLING UNSUCCESSFUL	<input type="checkbox"/>	... STANDARD PENETRATION TEST	<input type="checkbox"/>	... DRIVE SAMPLE (UNDISTURBED)
	<input checked="" type="checkbox"/>	... DISTURBED OR BAG SAMPLE	<input checked="" type="checkbox"/>	... CHUNK SAMPLE	<input type="checkbox"/>	... WATER TABLE OR SEEPAGE

NOTE: THE LOG OF SUBSURFACE CONDITIONS SHOWN HEREON APPLIES ONLY AT THE SPECIFIC BORING OR TRENCH LOCATION AND AT THE DATE INDICATED. IT IS NOT WARRANTED TO BE REPRESENTATIVE OF SUBSURFACE CONDITIONS AT OTHER LOCATIONS AND TIMES.



Elev. 470' (MSL)

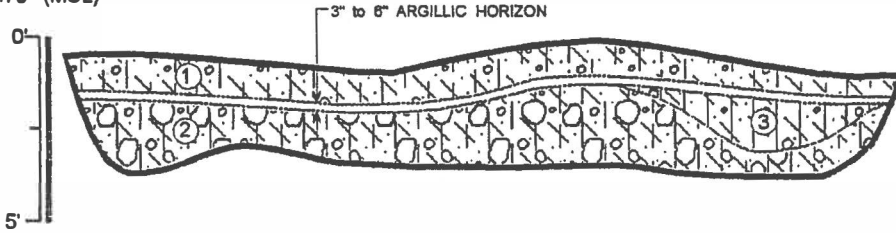

- ①.....TOPSOIL
Medium dense, damp, dark brown, Silty fine to medium SAND with few coarse gravel (SM)
- ②.....FRIARS FORMATION
Very dense, damp, orangish brown, Silty / Clayey fine to medium Sandy COBBLE CONGLOMERATE (GM / GC); moderately to highly cemented
- ③.....WEATHERED FRIARS FORMATION
Soft, moist, olive green, Clayey SILTSTONE with trace of fine to medium sand and few gravel (ML); undulatory contact between weathered siltstone and conglomerate



GEOCON
INCORPORATED



GEO TECHNICAL CONSULTANTS
6960 FLANDERS DRIVE - SAN DIEGO, CALIFORNIA 92121-2974
PHONE 619 558-6900 - FAX 619 558-6159

KPA / RSS

DSK / E0000

TRENCH T-131

FANITA RANCH
SANTEE, CALIFORNIA

DATE

PROJECT NO. 05254 - 52 - 02 | FIG. A-71

DEPTH IN FEET	SAMPLE NO.	LITHOLOGY	GROUNDWATER	TRENCH T155		PENETRATION RESISTANCE (BLOWS/FT.)	DRY DENSITY (P.C.F.)	MOISTURE CONTENT (%)
				SOIL CLASS (USCS)	ELEV. (MSL.) <u>615</u> DATE COMPLETED <u>5/11/95</u> EQUIPMENT <u>JD 555</u>			
MATERIAL DESCRIPTION								
0				GM/GC	TERRACE DEPOSIT Dense to very dense, damp, light orangish brown, Silty/Clayey, fine to medium Sandy GRAVEL/COBBLE CONGLOMERATE with abundant clasts of angular granitic rock			
2								
4								
6				ML	FRIARS FORMATION Dense, damp, olive-brown, fine Sandy SILTSTONE with a trace of clay BOTTOM OF TRENCH AT 7 FEET			

Figure A-72, Log of Trench T155

FRNC1

SAMPLE SYMBOLS	<input type="checkbox"/> ... SAMPLING UNSUCCESSFUL	<input type="checkbox"/> ... STANDARD PENETRATION TEST	<input type="checkbox"/> ... DRIVE SAMPLE (UNDISTURBED)
	<input checked="" type="checkbox"/> ... DISTURBED OR BAG SAMPLE	<input checked="" type="checkbox"/> ... CHUNK SAMPLE	<input type="checkbox"/> ... WATER TABLE OR SEEPAGE

NOTE: THE LOG OF SUBSURFACE CONDITIONS SHOWN HEREON APPLIES ONLY AT THE SPECIFIC BORING OR TRENCH LOCATION AND AT THE DATE INDICATED. IT IS NOT WARRANTED TO BE REPRESENTATIVE OF SUBSURFACE CONDITIONS AT OTHER LOCATIONS AND TIMES.

PROJECT NO. 05254-52-02

DEPTH IN FEET	SAMPLE NO.	LITHOLOGY	GROUNDWATER	TRENCH T156		PENETRATION RESISTANCE (BLOWS/FT.)	DRY DENSITY (P.C.F.)	MOISTURE CONTENT (%)
				SOIL CLASS (USCS)	ELEV. (MSL.) 1008 DATE COMPLETED 5/12/95			
					EQUIPMENT			
					JD 555			
MATERIAL DESCRIPTION								
0				CL	TOPSOIL Soft to stiff, damp to moist, dark reddish brown, fine to medium Sandy CLAY			
2		+			GRANITIC ROCK (GABBRO) Moderately weathered, orangish brown to grayish brown, moderately strong to strong, GRANITIC ROCK -Excavates to: Silty, fine to medium SAND, trace of clay			
4		+			-Becomes slightly weathered, dark gray and very strong at 3 feet -Excavates to: Silty, fine to medium SAND with 4 inch to 5 inch, angular fragments below 3 feet			
					BOTTOM OF TRENCH AT 5 FEET			

Figure A-1, Log of Trench T156

FRNC1

SAMPLE SYMBOLS	<input type="checkbox"/>	... SAMPLING UNSUCCESSFUL	<input type="checkbox"/>	... STANDARD PENETRATION TEST	<input type="checkbox"/>	... DRIVE SAMPLE (UNDISTURBED)
	<input checked="" type="checkbox"/>	... DISTURBED OR BAG SAMPLE	<input type="checkbox"/>	... CHUNK SAMPLE	<input type="checkbox"/>	... WATER TABLE OR SEEPAGE

NOTE: THE LOG OF SUBSURFACE CONDITIONS SHOWN HEREON APPLIES ONLY AT THE SPECIFIC BORING OR TRENCH LOCATION AND AT THE DATE INDICATED. IT IS NOT WARRANTED TO BE REPRESENTATIVE OF SUBSURFACE CONDITIONS AT OTHER LOCATIONS AND TIMES.

PROJECT NO. 05254-52-02

DEPTH IN FEET	SAMPLE NO.	LITHOLOGY	GROUNDWATER	TRENCH T157		PENETRATION RESISTANCE (BLOWS/FT.)	DRY DENSITY (P.C.F.)	MOISTURE CONTENT (%)
				SOIL CLASS (USCS)	ELEV. (MSL.) <u>1037</u> DATE COMPLETED <u>5/12/95</u> EQUIPMENT <u>JD 555</u>			
MATERIAL DESCRIPTION								
0				CL/GC	TOPSOIL Soft to stiff, damp to moist, dark brown to dark orangish brown, fine to medium Sandy CLAY with 3-inch to 6-inch cobbles			
2		+ +			GRANITIC ROCK (GABBRO) Moderately weathered, orangish brown to grayish brown, moderately strong to strong, GRANITIC ROCK -Excavates to: Silty, fine to medium SAND -Becomes slightly weathered, yellowish gray and very strong at 5 feet			
4		+ +						
6		+ +						
		+ +						
		+ +						
		+ +						
BOTTOM OF TRENCH AT 7.5 FEET								

Figure A-2, Log of Trench T157

FRNC1

SAMPLE SYMBOLS	<input type="checkbox"/> ... SAMPLING UNSUCCESSFUL	<input type="checkbox"/> ... STANDARD PENETRATION TEST	<input checked="" type="checkbox"/> ... DRIVE SAMPLE (UNDISTURBED)
	<input checked="" type="checkbox"/> ... DISTURBED OR BAG SAMPLE	<input checked="" type="checkbox"/> ... CHUNK SAMPLE	<input checked="" type="checkbox"/> ... WATER TABLE OR SEEPAGE

NOTE: THE LOG OF SUBSURFACE CONDITIONS SHOWN HEREON APPLIES ONLY AT THE SPECIFIC BORING OR TRENCH LOCATION AND AT THE DATE INDICATED. IT IS NOT WARRANTED TO BE REPRESENTATIVE OF SUBSURFACE CONDITIONS AT OTHER LOCATIONS AND TIMES.

PROJECT NO. 05254-52-02





DEPTH IN FEET	SAMPLE NO.	LITHOLOGY	GROUNDWATER	TRENCH T158		PENETRATION RESISTANCE (BLOWS/FT.)	DRY DENSITY (P.C.F.)	MOISTURE CONTENT (%)
				ELEV. (MSL.) <u>1055</u>	DATE COMPLETED <u>5/12/95</u>			
				SOIL CLASS (USCS)	EQUIPMENT <u>JD 555</u>			
MATERIAL DESCRIPTION								
0				SM/SC	TOPSOIL Loose, damp, medium brown, Silty/Clayey, fine to medium SAND with gravel and 3 inch to 8 inch diameter cobbles			
2				GM	STADIUM CONGLOMERATE Very dense, damp, orangish brown, Silty, fine to medium Sandy GRAVEL/COBBLE CONGLOMERATE ; highly cemented matrix, maximum clast size 8 inches			
BOTTOM OF TRENCH AT 3 FEET								

Figure A-3, Log of Trench T158

FRNC1

SAMPLE SYMBOLS	<input type="checkbox"/>	... SAMPLING UNSUCCESSFUL	<input type="checkbox"/>	... STANDARD PENETRATION TEST	<input type="checkbox"/>	... DRIVE SAMPLE (UNDISTURBED)
		... DISTURBED OR BAG SAMPLE		... CHUNK SAMPLE		... WATER TABLE OR SEEPAGE

NOTE: THE LOG OF SUBSURFACE CONDITIONS SHOWN HEREON APPLIES ONLY AT THE SPECIFIC BORING OR TRENCH LOCATION AND AT THE DATE INDICATED. IT IS NOT WARRANTED TO BE REPRESENTATIVE OF SUBSURFACE CONDITIONS AT OTHER LOCATIONS AND TIMES.

PROJECT NO. 05254-52-02

DEPTH IN FEET	SAMPLE NO.	LITHOLOGY	GROUNDWATER	SOIL CLASS (USCS)	TRENCH T159			PENETRATION RESISTANCE (BLOWS/FT.)	DRY DENSITY (P.C.F.)	MOISTURE CONTENT (%)	
					ELEV. (MSL.)	DATE COMPLETED	EQUIPMENT				
					ELEV. (MSL.)	1190	DATE COMPLETED	5/12/95			
					EQUIPMENT		JD 555				
MATERIAL DESCRIPTION											
0				SM/GM	TOPSOIL Loose to medium dense, damp, orangish brown, Silty, fine to medium SAND with gravel and few, 3 inch to 5 inch diameter cobbles; trace of clay						
2				GM	STADIUM CONGLOMERATE Very dense, damp, orangish brown to yellowish brown, Silty/Clayey, fine to medium Sandy GRAVEL/COBBLE CONGLOMERATE; predominant clast size 3 inches to 8 inches; highly to completely cemented matrix						
4					BOTTOM OF TRENCH AT 4.5 FEET						

Figure A-4, Log of Trench T159

FRNC1

SAMPLE SYMBOLS	<input type="checkbox"/>	... SAMPLING UNSUCCESSFUL	<input type="checkbox"/>	... STANDARD PENETRATION TEST	<input checked="" type="checkbox"/>	... DRIVE SAMPLE (UNDISTURBED)
	<input checked="" type="checkbox"/>	... DISTURBED OR BAG SAMPLE	<input checked="" type="checkbox"/>	... CHUNK SAMPLE	<input checked="" type="checkbox"/>	... WATER TABLE OR SEEPAGE

NOTE: THE LOG OF SUBSURFACE CONDITIONS SHOWN HEREON APPLIES ONLY AT THE SPECIFIC BORING OR TRENCH LOCATION AND AT THE DATE INDICATED. IT IS NOT WARRANTED TO BE REPRESENTATIVE OF SUBSURFACE CONDITIONS AT OTHER LOCATIONS AND TIMES.

PROJECT NO. 05254-52-02



DEPTH IN FEET	SAMPLE NO.	LITHOLOGY	GROUNDWATER	TRENCH T160		PENETRATION RESISTANCE (BLOWS/FT.)	DRY DENSITY (P.C.F.)	MOISTURE CONTENT (%)
				SOIL CLASS (USCS)	ELEV. (MSL.) <u>1183</u> DATE COMPLETED <u>5/12/95</u> EQUIPMENT <u>JD 555</u>			
MATERIAL DESCRIPTION								
0				SM/GM	TOPSOIL Loose, damp, medium brown, Silty, fine to medium SAND with gravel and 3 inch to 5 inch diameter cobbles			
2				GM	STADIUM CONGLOMERATE Very dense, damp, orangish brown to yellowish brown, fine to medium Sandy GRAVEL/COBBLE CONGLOMERATE; moderately to highly cemented			
4					BOTTOM OF TRENCH AT 4 FEET			

Figure A-5, Log of Trench T160

FRNC1

SAMPLE SYMBOLS	<input type="checkbox"/> ... SAMPLING UNSUCCESSFUL	<input type="checkbox"/> ... STANDARD PENETRATION TEST	<input checked="" type="checkbox"/> ... DRIVE SAMPLE (UNDISTURBED)
	<input checked="" type="checkbox"/> ... DISTURBED OR BAG SAMPLE	<input checked="" type="checkbox"/> ... CHUNK SAMPLE	 ... WATER TABLE OR SEEPAGE

NOTE: THE LOG OF SUBSURFACE CONDITIONS SHOWN HEREON APPLIES ONLY AT THE SPECIFIC BORING OR TRENCH LOCATION AND AT THE DATE INDICATED. IT IS NOT WARRANTED TO BE REPRESENTATIVE OF SUBSURFACE CONDITIONS AT OTHER LOCATIONS AND TIMES.

PROJECT NO. 05254-52-02



DEPTH IN FEET	SAMPLE NO.	LITHOLOGY	GROUNDWATER	SOIL CLASS (USCS)	TRENCH T161			PENETRATION RESISTANCE (BLOWS/FT.)	DRY DENSITY (P.C.F.)	MOISTURE CONTENT (%)
					ELEV. (MSL.) <u>936</u>	DATE COMPLETED <u>5/12/95</u>	EQUIPMENT <u>JD 555</u>			
MATERIAL DESCRIPTION										
0				SC/GC	ALLUVIUM Loose, wet, dark brown, Clayey, fine to medium SAND with gravel and cobble -Slight to moderate seepage at 3 feet					
2					GRANITIC ROCK (GABBRO) Moderately to highly weathered, orangish brown, moderately strong, GRANITIC ROCK					
4					BOTTOM OF TRENCH AT 4.5 FEET					

Figure A-6, Log of Trench T161

FRNC1

SAMPLE SYMBOLS	<input type="checkbox"/> ... SAMPLING UNSUCCESSFUL	<input type="checkbox"/> ... STANDARD PENETRATION TEST	<input checked="" type="checkbox"/> ... DRIVE SAMPLE (UNDISTURBED)
	<input checked="" type="checkbox"/> ... DISTURBED OR BAG SAMPLE	<input checked="" type="checkbox"/> ... CHUNK SAMPLE	 ... WATER TABLE OR SEEPAGE

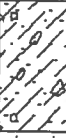
NOTE: THE LOG OF SUBSURFACE CONDITIONS SHOWN HEREON APPLIES ONLY AT THE SPECIFIC BORING OR TRENCH LOCATION AND AT THE DATE INDICATED. IT IS NOT WARRANTED TO BE REPRESENTATIVE OF SUBSURFACE CONDITIONS AT OTHER LOCATIONS AND TIMES.

PROJECT NO. 05254-52-02

DEPTH IN FEET	SAMPLE NO.	LITHOLOGY	GROUNDWATER	TRENCH T162		PENETRATION RESISTANCE (BLOWS/FT.)	DRY DENSITY (P.C.F.)	MOISTURE CONTENT (%)
				SOIL CLASS (USCS)	ELEV. (MSL.) <u>877</u> DATE COMPLETED <u>5/12/95</u> EQUIPMENT <u>JD 555</u>			
MATERIAL DESCRIPTION								
0				GM	ALLUVIUM Loose, moist, dark brown, Silty, fine to medium SAND with a trace of clay and abundant 3 inch to 12 inch diameter cobble; scattered boulders			
2				CL/GC	Stiff, very moist, orangish brown, fine to medium Sandy CLAY with 3 inch to 4 inch diameter cobble and granitic rock fragments			
4					GRANITIC ROCK (GABBRO) Moderately weathered, orangish brown to gray, strong, GRANITIC ROCK -Becomes slightly weathered and very strong at 6 feet			
6					BOTTOM OF TRENCH AT 7 FEET			

Figure A-7, Log of Trench T162

FRNC1

SAMPLE SYMBOLS	<input type="checkbox"/>	... SAMPLING UNSUCCESSFUL	<input type="checkbox"/>	... STANDARD PENETRATION TEST	<input checked="" type="checkbox"/>	... DRIVE SAMPLE (UNDISTURBED)
	<input checked="" type="checkbox"/>	... DISTURBED OR BAG SAMPLE	<input checked="" type="checkbox"/>	... CHUNK SAMPLE	<input checked="" type="checkbox"/>	... WATER TABLE OR SEEPAGE

NOTE: THE LOG OF SUBSURFACE CONDITIONS SHOWN HEREON APPLIES ONLY AT THE SPECIFIC BORING OR TRENCH LOCATION AND AT THE DATE INDICATED. IT IS NOT WARRANTED TO BE REPRESENTATIVE OF SUBSURFACE CONDITIONS AT OTHER LOCATIONS AND TIMES.

PROJECT NO. 05254-52-02

DEPTH IN FEET	SAMPLE NO.	LITHOLOGY	GROUNDWATER	TRENCH T163		PENETRATION RESISTANCE (BLOWS/FT.)	DRY DENSITY (P.C.F.)	MOISTURE CONTENT (%)
				ELEV. (MSL.) <u>1062</u>	DATE COMPLETED <u>5/12/95</u>			
					EQUIPMENT <u>JD 555</u>			
MATERIAL DESCRIPTION								
0				GC	COLLUVIUM Soft to stiff, moist, dark brown, fine to medium Sandy CLAY, with abundant gravel and 3 inch to 6 inch diameter cobbles			
2								
4					GRANITIC ROCK (GABBRO) Slightly weathered, gray, very strong GRANITIC ROCK BOTTOM OF TRENCH AT 5 FEET			

Figure A-8, Log of Trench T163

FRNC1

SAMPLE SYMBOLS	<input type="checkbox"/>	... SAMPLING UNSUCCESSFUL	<input type="checkbox"/>	... STANDARD PENETRATION TEST	<input type="checkbox"/>	... DRIVE SAMPLE (UNDISTURBED)
		... DISTURBED OR BAG SAMPLE		... CHUNK SAMPLE		... WATER TABLE OR SEEPAGE

NOTE: THE LOG OF SUBSURFACE CONDITIONS SHOWN HEREON APPLIES ONLY AT THE SPECIFIC BORING OR TRENCH LOCATION AND AT THE DATE INDICATED. IT IS NOT WARRANTED TO BE REPRESENTATIVE OF SUBSURFACE CONDITIONS AT OTHER LOCATIONS AND TIMES.

PROJECT NO. 05254-52-02

DEPTH IN FEET	SAMPLE NO.	LITHOLOGY	GROUNDWATER	TRENCH T164		PENETRATION RESISTANCE (BLOWS/FT.)	DRY DENSITY (P.C.F.)	MOISTURE CONTENT (%)	
				ELEV. (MSL.) <u>1095</u>	DATE COMPLETED <u>5/12/95</u>				
				SOIL CLASS (USCS)	EQUIPMENT <u>JD 555</u>				
MATERIAL DESCRIPTION									
0				CL/GC	TOPSOIL Soft, moist, dark brown, fine to medium Sandy CLAY, with abundant gravel and cobble				
2			+ +			GRANITIC ROCK (GABBRO) Moderately to highly weathered, greenish gray, weak to moderately strong, GRANITIC ROCK			
4			+ +			BOTTOM OF TRENCH AT 4 FEET			

Figure A-9, Log of Trench T164

FRNC1

SAMPLE SYMBOLS	<input type="checkbox"/>	... SAMPLING UNSUCCESSFUL	<input type="checkbox"/>	... STANDARD PENETRATION TEST	<input type="checkbox"/>	... DRIVE SAMPLE (UNDISTURBED)
	<input checked="" type="checkbox"/>	... DISTURBED OR BAG SAMPLE	<input type="checkbox"/>	... CHUNK SAMPLE	<input type="checkbox"/>	... WATER TABLE OR SEEPAGE

NOTE: THE LOG OF SUBSURFACE CONDITIONS SHOWN HEREON APPLIES ONLY AT THE SPECIFIC BORING OR TRENCH LOCATION AND AT THE DATE INDICATED. IT IS NOT WARRANTED TO BE REPRESENTATIVE OF SUBSURFACE CONDITIONS AT OTHER LOCATIONS AND TIMES.

PROJECT NO. 05254-52-02



DEPTH IN FEET	SAMPLE NO.	LITHOLOGY	GROUNDWATER	TRENCH T165		PENETRATION RESISTANCE (BLOWS/FT.)	DRY DENSITY (P.C.F.)	MOISTURE CONTENT (%)
				ELEV. (MSL.) 1102	DATE COMPLETED 5/12/95			
					EQUIPMENT JD 555			
MATERIAL DESCRIPTION								
0				SM/GM	TOPSOIL Loose to medium dense, damp, medium brown, Silty, fine to medium SAND with abundant gravel and small cobble			
2					STADIUM CONGLOMERATE Very dense, damp, orangish brown to grayish brown, Sandy GRAVEL/COBBLE CONGLOMERATE; maximum clast size 8 inches, highly to completely cemented			
					BOTTOM OF TRENCH AT 3 FEET			

Figure A-10, Log of Trench T165

FRNC1

SAMPLE SYMBOLS	<input type="checkbox"/>	... SAMPLING UNSUCCESSFUL	<input type="checkbox"/>	... STANDARD PENETRATION TEST	<input type="checkbox"/>	... DRIVE SAMPLE (UNDISTURBED)
	<input checked="" type="checkbox"/>	... DISTURBED OR BAG SAMPLE	<input type="checkbox"/>	... CHUNK SAMPLE		... WATER TABLE OR SEEPAGE

NOTE: THE LOG OF SUBSURFACE CONDITIONS SHOWN HEREON APPLIES ONLY AT THE SPECIFIC BORING OR TRENCH LOCATION AND AT THE DATE INDICATED. IT IS NOT WARRANTED TO BE REPRESENTATIVE OF SUBSURFACE CONDITIONS AT OTHER LOCATIONS AND TIMES.

PROJECT NO. 05254-52-02



DEPTH IN FEET	SAMPLE NO.	LITHOLOGY	GROUNDWATER	TRENCH T166		PENETRATION RESISTANCE (BLOWS/FT.)	DRY DENSITY (P.C.F.)	MOISTURE CONTENT (%)
				SOIL CLASS (USCS)	ELEV. (MSL.) <u>1082</u> DATE COMPLETED <u>5/12/95</u> EQUIPMENT <u>JD 555</u>			
MATERIAL DESCRIPTION								
0				CL/GC	TOPSOIL Soft to stiff, moist, orangish brown, fine to medium Sandy CLAY with GRAVEL and 3-inch to 4-inch COBBLES			
2				GC	STADIUM CONGLOMERATE Very dense, damp, orangish brown to grayish brown, Clayey, fine to medium Sandy GRAVEL/COBBLE CONGLOMERATE; maximum clast size 8 inches; highly cemented			
					GRANITIC ROCK (GABBRO) Moderately weathered, greenish gray, weak to moderately strong, GRANITIC ROCK			
BOTTOM OF TRENCH AT 3.5 FEET								

Figure A-11, Log of Trench T166

FRNC1

SAMPLE SYMBOLS	<input type="checkbox"/> ... SAMPLING UNSUCCESSFUL	<input type="checkbox"/> ... STANDARD PENETRATION TEST	<input checked="" type="checkbox"/> ... DRIVE SAMPLE (UNDISTURBED)
	 ... DISTURBED OR BAG SAMPLE	 ... CHUNK SAMPLE	 ... WATER TABLE OR SEEPAGE

NOTE: THE LOG OF SUBSURFACE CONDITIONS SHOWN HEREON APPLIES ONLY AT THE SPECIFIC BORING OR TRENCH LOCATION AND AT THE DATE INDICATED. IT IS NOT WARRANTED TO BE REPRESENTATIVE OF SUBSURFACE CONDITIONS AT OTHER LOCATIONS AND TIMES.

PROJECT NO. 05254-52-02

DEPTH IN FEET	SAMPLE NO.	LITHOLOGY	GROUNDWATER	SOIL CLASS (USCS)	TRENCH T167			PENETRATION RESISTANCE (BLOWS/FT.)	DRY DENSITY (P.C.F.)	MOISTURE CONTENT (%)	
					ELEV. (MSL.)	DATE COMPLETED	EQUIPMENT				
					ELEV. (MSL.)	730	DATE COMPLETED	5/12/95			
					EQUIPMENT		JD 555				
0					MATERIAL DESCRIPTION						
2		B P A		GC	ALLUVIUM Loose to medium dense, very moist, dark brown, Clayey, fine to medium SAND, with abundant cobble up to 12 inches diameter and boulders						
4		B P A									
6		+ + + +			GRANITIC ROCK (GABBRO) Moderately weathered, orangish brown, weak to moderately strong, GRANITIC ROCK -Excavates to: Silty, fine to coarse SAND						
					BOTTOM OF TRENCH AT 7 FEET						

Figure A-12, Log of Trench T167

FRNC1

SAMPLE SYMBOLS	<input type="checkbox"/>	... SAMPLING UNSUCCESSFUL	<input type="checkbox"/>	... STANDARD PENETRATION TEST	<input type="checkbox"/>	... DRIVE SAMPLE (UNDISTURBED)
	<input checked="" type="checkbox"/>	... DISTURBED OR BAG SAMPLE	<input type="checkbox"/>	... CHUNK SAMPLE	<input type="checkbox"/>	... WATER TABLE OR SEEPAGE

NOTE: THE LOG OF SUBSURFACE CONDITIONS SHOWN HEREON APPLIES ONLY AT THE SPECIFIC BORING OR TRENCH LOCATION AND AT THE DATE INDICATED. IT IS NOT WARRANTED TO BE REPRESENTATIVE OF SUBSURFACE CONDITIONS AT OTHER LOCATIONS AND TIMES.

DEPTH IN FEET	SAMPLE NO.	LITHOLOGY	GROUNDWATER	TRENCH T168		PENETRATION RESISTANCE (BLOWS/FT.)	DRY DENSITY (P.C.F.)	MOISTURE CONTENT (%)
				ELEV. (MSL.) <u>680</u>	DATE COMPLETED <u>5/12/95</u>			
				EQUIPMENT <u>JD 555</u>				
MATERIAL DESCRIPTION								
0				SM/GM	ALLUVIUM			
2					Loose, moist, medium brown, Silty, fine to medium SAND with gravel and cobbles up to 12 inches in diameter; few 1.5 to 2 foot boulders			
4								
6					GRANITIC ROCK			
					Moderately weathered, orangish brown to grayish brown, moderately strong, GRANITIC ROCK			
					-Excavates to: Silty, fine to coarse SAND			
					BOTTOM OF TRENCH AT 7 FEET			

Figure A-73, Log of Trench T168

FRNC1

SAMPLE SYMBOLS	<input type="checkbox"/> ... SAMPLING UNSUCCESSFUL	<input type="checkbox"/> ... STANDARD PENETRATION TEST	<input checked="" type="checkbox"/> ... DRIVE SAMPLE (UNDISTURBED)
	<input checked="" type="checkbox"/> ... DISTURBED OR BAG SAMPLE	<input checked="" type="checkbox"/> ... CHUNK SAMPLE	... WATER TABLE OR SEEPAGE

NOTE: THE LOG OF SUBSURFACE CONDITIONS SHOWN HEREON APPLIES ONLY AT THE SPECIFIC BORING OR TRENCH LOCATION AND AT THE DATE INDICATED. IT IS NOT WARRANTED TO BE REPRESENTATIVE OF SUBSURFACE CONDITIONS AT OTHER LOCATIONS AND TIMES.

PROJECT NO. 05254-52-02

DEPTH IN FEET	SAMPLE NO.	LITHOLOGY	GROUNDWATER	SOIL CLASS (USCS)	TRENCH T169		PENETRATION RESISTANCE (BLOWS/FT.)	DRY DENSITY (P.C.F.)	MOISTURE CONTENT (%)	
					ELEV. (MSL.) <u>680</u>	DATE COMPLETED <u>5/12/95</u>				
					EQUIPMENT <u>JD 555</u>					
					MATERIAL DESCRIPTION					
0				SM/GM	ALLUVIUM Loose, moist, reddish brown, Silty, fine to medium SAND with gravel and 3 inch to 6 inch in diameter cobbles -Becomes fine to medium sandy clay with gravel and cobbles at 1 foot GRANITIC ROCK Moderately weathered, greenish gray, moderately strong, GRANITIC ROCK BOTTOM OF TRENCH AT 4.5 FEET					
2										
4										

Figure A-74, Log of Trench T169

FRNC1

SAMPLE SYMBOLS	<input type="checkbox"/>	... SAMPLING UNSUCCESSFUL	<input type="checkbox"/>	... STANDARD PENETRATION TEST	<input checked="" type="checkbox"/>	... DRIVE SAMPLE (UNDISTURBED)
	<input checked="" type="checkbox"/>	... DISTURBED OR BAG SAMPLE	<input checked="" type="checkbox"/>	... CHUNK SAMPLE		... WATER TABLE OR SEEPAGE

NOTE: THE LOG OF SUBSURFACE CONDITIONS SHOWN HEREON APPLIES ONLY AT THE SPECIFIC BORING OR TRENCH LOCATION AND AT THE DATE INDICATED. IT IS NOT WARRANTED TO BE REPRESENTATIVE OF SUBSURFACE CONDITIONS AT OTHER LOCATIONS AND TIMES.

PROJECT NO. 05254-52-02

DEPTH IN FEET	SAMPLE NO.	LITHOLOGY	GROUNDWATER	SOIL CLASS (USCS)	TRENCH T170		PENETRATION RESISTANCE (BLOWS/FT.)	DRY DENSITY (P.C.F.)	MOISTURE CONTENT (%)
					ELEV. (MSL.) 635	DATE COMPLETED 5/12/95			
					EQUIPMENT JD 555				
MATERIAL DESCRIPTION									
0				CL/GC	ALLUVIUM Loose, moist, dark reddish brown, fine to medium Sandy CLAY with gravel and cobbles; few angular granitic rock fragments				
2									
4									
6									
8					GRANITIC ROCK Moderately to highly weathered, orangish brown, moderately weak to moderately strong, GRANITIC ROCK				
10									
12									
BOTTOM OF TRENCH AT 12 FEET									

Figure A-75, Log of Trench T170

FRNC1

SAMPLE SYMBOLS	... SAMPLING UNSUCCESSFUL	... STANDARD PENETRATION TEST	... DRIVE SAMPLE (UNDISTURBED)
	... DISTURBED OR BAG SAMPLE	... CHUNK SAMPLE	... WATER TABLE OR SEEPAGE

NOTE: THE LOG OF SUBSURFACE CONDITIONS SHOWN HEREON APPLIES ONLY AT THE SPECIFIC BORING OR TRENCH LOCATION AND AT THE DATE INDICATED. IT IS NOT WARRANTED TO BE REPRESENTATIVE OF SUBSURFACE CONDITIONS AT OTHER LOCATIONS AND TIMES.

DEPTH IN FEET	SAMPLE NO.	LITHOLOGY	GROUNDWATER	TRENCH T171		PENETRATION RESISTANCE (BLOWS/FT.)	DRY DENSITY (P.C.F.)	MOISTURE CONTENT (%)	
				SOIL CLASS (USCS)	ELEV. (MSL.) <u>500</u> DATE COMPLETED <u>7/13/95</u> EQUIPMENT <u>JD 555</u>				
MATERIAL DESCRIPTION									
0				SM/SC/GC	COLLUVIUM Loose, damp, medium brown, Silty/Clayey, fine to medium SAND with gravel and cobbles up to 4 inches in diameter				
2					CL/GC	Firm, moist, medium brown to dark brown, fine to medium Sandy CLAY with gravel and cobble; Predominant clasts size 4 inches with occasional 8 inches			
4				ML	WEATHERED FRIARS FORMATION Soft to firm, moist, olive green to olive brown, Clayey SILT				
6					ML/CL	FRIARS FORMATION Dense, damp to moist, olive green to olive brown, Clayey SILTSTONE to Silty CLAYSTONE -Increased in density at 10 feet -Black oxide staining from 10 to 12 feet			
8									
10									
12					BOTTOM OF TRENCH AT 12 FEET				

Figure A-76, Log of Trench T171

FRNC1

SAMPLE SYMBOLS	<input type="checkbox"/> ... SAMPLING UNSUCCESSFUL	<input type="checkbox"/> ... STANDARD PENETRATION TEST	<input type="checkbox"/> ... DRIVE SAMPLE (UNDISTURBED)
	<input checked="" type="checkbox"/> ... DISTURBED OR BAG SAMPLE	<input checked="" type="checkbox"/> ... CHUNK SAMPLE	<input type="checkbox"/> ... WATER TABLE OR SEEPAGE

NOTE: THE LOG OF SUBSURFACE CONDITIONS SHOWN HEREON APPLIES ONLY AT THE SPECIFIC BORING OR TRENCH LOCATION AND AT THE DATE INDICATED. IT IS NOT WARRANTED TO BE REPRESENTATIVE OF SUBSURFACE CONDITIONS AT OTHER LOCATIONS AND TIMES.

PROJECT NO. 05254-52-02

DEPTH IN FEET	SAMPLE NO.	LITHOLOGY	GROUNDWATER	SOIL CLASS (USCS)	TRENCH T172		PENETRATION RESISTANCE (BLOWS/FT.)	DRY DENSITY (P.C.F.)	MOISTURE CONTENT (%)
					ELEV. (MSL.) 530	DATE COMPLETED 7/13/95			
					EQUIPMENT JD 555				
MATERIAL DESCRIPTION									
0				SC/GC	TOPSOIL Loose, dry to damp, medium brown, Silty to Clayey, fine to medium SAND with gravel and cobbles up to 8 inches in diameter				
2				GM/GC	LANDSLIDE DEBRIS ? (BLOCK) Dense, damp to moist, yellowish gray to yellowish brown, Silty/Clayey, fine to medium Sandy GRAVEL/COBBLE CONGLOMERATE; Zones of slight to moderate cementation, cobble clasts up to 2 feet in diameter				
4									
6									
8									
10									
12					BOTTOM OF TRENCH AT 12 FEET				

Figure A-77, Log of Trench T172

FRNC1

SAMPLE SYMBOLS	<input type="checkbox"/>	... SAMPLING UNSUCCESSFUL	<input type="checkbox"/>	... STANDARD PENETRATION TEST	<input type="checkbox"/>	... DRIVE SAMPLE (UNDISTURBED)
		... DISTURBED OR BAG SAMPLE		... CHUNK SAMPLE		... WATER TABLE OR SEEPAGE

NOTE: THE LOG OF SUBSURFACE CONDITIONS SHOWN HEREON APPLIES ONLY AT THE SPECIFIC BORING OR TRENCH LOCATION AND AT THE DATE INDICATED. IT IS NOT WARRANTED TO BE REPRESENTATIVE OF SUBSURFACE CONDITIONS AT OTHER LOCATIONS AND TIMES.

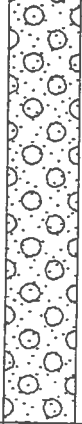

DEPTH IN FEET	SAMPLE NO.	LITHOLOGY	GROUNDWATER	SOIL CLASS (USCS)	TRENCH T173		PENETRATION RESISTANCE (BLOWS/FT.)	DRY DENSITY (P.C.F.)	MOISTURE CONTENT (%)
					ELEV. (MSL.) <u>515</u>	DATE COMPLETED <u>7/13/95</u>			
					EQUIPMENT <u>JD 555</u>				
MATERIAL DESCRIPTION									
0				SM/SC	TOPSOIL Loose, dry to damp, medium brown, Silty to Clayey, fine to medium SAND with gravel and cobbles up to 12 inches in diameter; abundant rootlets				
2				GM/GC	LANDSLIDE DEBRIS (BLOCKY)? Dense, damp to moist, yellowish gray to yellowish brown, Silty to Clayey, fine to medium Sandy GRAVEL/COBBLE CONGLOMERATE				
4				SM/SC	Dense, damp to moist, light brownish gray, Silty to Clayey, fine to medium SANDSTONE -1 foot thick gravel/cobble lense from 7.5 to 8 feet				
6									
8									
10									
12				GC	Dense, damp, yellowish gray to yellowish brown, Clayey, fine to medium Sandy GRAVEL/COBBLE CONGLOMERATE; Boulders up to 15 inches in diameter, slightly cemented				
14									
BOTTOM OF TRENCH AT 12 FEET									

Figure A-78, Log of Trench T173

FRNC1

SAMPLE SYMBOLS		... SAMPLING UNSUCCESSFUL		... STANDARD PENETRATION TEST		... DRIVE SAMPLE (UNDISTURBED)
		... DISTURBED OR BAG SAMPLE		... CHUNK SAMPLE		... WATER TABLE OR SEEPAGE

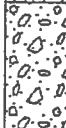
NOTE: THE LOG OF SUBSURFACE CONDITIONS SHOWN HEREON APPLIES ONLY AT THE SPECIFIC BORING OR TRENCH LOCATION AND AT THE DATE INDICATED. IT IS NOT WARRANTED TO BE REPRESENTATIVE OF SUBSURFACE CONDITIONS AT OTHER LOCATIONS AND TIMES.



DEPTH IN FEET	SAMPLE NO.	LITHOLOGY	GROUNDWATER	SOIL CLASS (USCS)	TRENCH T174		PENETRATION RESISTANCE (BLOWS/FT.)	DRY DENSITY (P.C.F.)	MOISTURE CONTENT (%)
					ELEV. (MSL.) 535	DATE COMPLETED 7/13/95			
					EQUIPMENT				
					JD 555				
MATERIAL DESCRIPTION									
0				SM/SC	TOPSOIL Loose, dry to damp, medium brown, Silty to Clayey, fine to medium SAND with gravel and cobbles up to 12 inches in diameter; abundant rootlets				
2				GM/GC	LANDSLIDE DEBRIS Dense, damp to moist, yellowish gray to yellowish brown, Silty to Clayey, fine to medium Sandy GRAVEL/COBBLE CONGLOMERATE; boulders up to 15 inches in diameter, zones of slight to moderate cementation				
4									
6									
8									
10									
BOTTOM OF TRENCH AT 15 FEET									

Figure A-79, Log of Trench T174

FRNC1

SAMPLE SYMBOLS	<input type="checkbox"/>	... SAMPLING UNSUCCESSFUL	<input type="checkbox"/>	... STANDARD PENETRATION TEST	<input type="checkbox"/>	... DRIVE SAMPLE (UNDISTURBED)
	<input checked="" type="checkbox"/>	... DISTURBED OR BAG SAMPLE	<input type="checkbox"/>	... CHUNK SAMPLE		... WATER TABLE OR SEEPAGE

NOTE: THE LOG OF SUBSURFACE CONDITIONS SHOWN HEREON APPLIES ONLY AT THE SPECIFIC BORING OR TRENCH LOCATION AND AT THE DATE INDICATED. IT IS NOT WARRANTED TO BE REPRESENTATIVE OF SUBSURFACE CONDITIONS AT OTHER LOCATIONS AND TIMES.

DEPTH IN FEET	SAMPLE NO.	LITHOLOGY	GROUNDWATER	TRENCH T175		PENETRATION RESISTANCE (BLOWS/FT.)	DRY DENSITY (P.C.F.)	MOISTURE CONTENT (%)
				ELEV. (MSL.) <u>500</u>	DATE COMPLETED <u>7/13/95</u>			
				EQUIPMENT <u>JD 555</u>				
MATERIAL DESCRIPTION								
0				<p>ALLUVIUM Loose, moist, dark brown, Silty to Clayey, fine to medium SAND with gravel and cobbles up to 8 inches in diameter</p> <p>-Slight seepage from 5 to 6 feet</p> <p>FRIARS FORMATION Medium dense, moist, olive green to olive brown, Clayey SILTSTONE/Silty CLAYSTONE; slightly weathered to 7 feet -Becomes olive brown at 7 feet -Gravel and cobbles at 9 feet</p> <p>BOTTOM OF TRENCH AT 11 FEET TRENCH LOGGED FROM SURFACE BELOW 8 FEET</p>				
2			SM/SC/ GM/GC					
4			ML/CL					
6								
8								
10								

Figure A-80, Log of Trench T175

FRNC1

SAMPLE SYMBOLS	<input type="checkbox"/>	... SAMPLING UNSUCCESSFUL	<input type="checkbox"/>	... STANDARD PENETRATION TEST	<input type="checkbox"/>	... DRIVE SAMPLE (UNDISTURBED)
	<input checked="" type="checkbox"/>	... DISTURBED OR BAG SAMPLE	<input type="checkbox"/>	... CHUNK SAMPLE		... WATER TABLE OR SEEPAGE

NOTE: THE LOG OF SUBSURFACE CONDITIONS SHOWN HEREON APPLIES ONLY AT THE SPECIFIC BORING OR TRENCH LOCATION AND AT THE DATE INDICATED. IT IS NOT WARRANTED TO BE REPRESENTATIVE OF SUBSURFACE CONDITIONS AT OTHER LOCATIONS AND TIMES.

PROJECT NO. 05254-52-02



DEPTH IN FEET	SAMPLE NO.	LITHOLOGY	GROUNDWATER	TRENCH T176		PENETRATION RESISTANCE (BLOWS/FT.)	DRY DENSITY (P.C.F.)	MOISTURE CONTENT (%)
				SOIL CLASS (USCS)	ELEV. (MSL.) <u>555</u> DATE COMPLETED <u>7/13/95</u> EQUIPMENT <u>JD 555</u>			
MATERIAL DESCRIPTION								
0				SM/SC	TOPSOIL Loose, dry to damp, medium brown, Silty to Clayey, fine to medium SAND with gravel and cobbles			
2						GC	FRIARS FORMATION Dense to very dense, damp, orangish brown, Clayey, fine to medium Sandy GRAVEL/COBBLE CONGLOMERATE; Boulders up to 18 inches in diameter, slightly to moderately cemented	
4								
6								
8		BOTTOM OF TRENCH AT 8 FEET						

Figure A-81, Log of Trench T176

FRNC1

SAMPLE SYMBOLS	<input type="checkbox"/>	... SAMPLING UNSUCCESSFUL	<input type="checkbox"/>	... STANDARD PENETRATION TEST	<input type="checkbox"/>	... DRIVE SAMPLE (UNDISTURBED)
	<input checked="" type="checkbox"/>	... DISTURBED OR BAG SAMPLE	<input checked="" type="checkbox"/>	... CHUNK SAMPLE		... WATER TABLE OR SEEPAGE

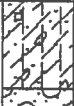
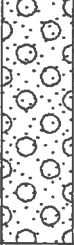
NOTE: THE LOG OF SUBSURFACE CONDITIONS SHOWN HEREON APPLIES ONLY AT THE SPECIFIC BORING OR TRENCH LOCATION AND AT THE DATE INDICATED. IT IS NOT WARRANTED TO BE REPRESENTATIVE OF SUBSURFACE CONDITIONS AT OTHER LOCATIONS AND TIMES.

PROJECT NO. 05254-52-02



DEPTH IN FEET	SAMPLE NO.	LITHOLOGY	GROUNDWATER	SOIL CLASS (USCS)	TRENCH T177		PENETRATION RESISTANCE (BLOWS/FT.)	DRY DENSITY (P.C.F.)	MOISTURE CONTENT (%)
					ELEV. (MSL.) <u>535</u>	DATE COMPLETED <u>7/13/95</u>			
					EQUIPMENT <u>JD 555</u>				
MATERIAL DESCRIPTION									
0									
2				SC/GC	TOPSOIL Stiff, damp to moist, dark brown, Silty CLAY with some fine to medium SAND, trace of coarse sand				
4					GRANITIC ROCK Slightly weathered, orangish gray, strong, GRANITIC ROCK -Excavates to: Silty, fine to coarse SAND				
BOTTOM OF TRENCH AT 4.5 FEET									

Figure A-82, Log of Trench T177

FRNC1

SAMPLE SYMBOLS	<input type="checkbox"/>	... SAMPLING UNSUCCESSFUL	<input type="checkbox"/>	... STANDARD PENETRATION TEST	<input type="checkbox"/>	... DRIVE SAMPLE (UNDISTURBED)
	<input checked="" type="checkbox"/>	... DISTURBED OR BAG SAMPLE	<input type="checkbox"/>	... CHUNK SAMPLE		... WATER TABLE OR SEEPAGE

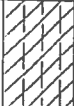
NOTE: THE LOG OF SUBSURFACE CONDITIONS SHOWN HEREON APPLIES ONLY AT THE SPECIFIC BORING OR TRENCH LOCATION AND AT THE DATE INDICATED. IT IS NOT WARRANTED TO BE REPRESENTATIVE OF SUBSURFACE CONDITIONS AT OTHER LOCATIONS AND TIMES.

DEPTH IN FEET	SAMPLE NO.	LITHOLOGY	GROUNDWATER	TRENCH T178		PENETRATION RESISTANCE (BLOWS/FT.)	DRY DENSITY (P.C.F.)	MOISTURE CONTENT (%)
				ELEV. (MSL.) 510	DATE COMPLETED 7/13/95			
EQUIPMENT JD 555								
MATERIAL DESCRIPTION								
0					ALLUVIUM Loose, damp to moist, dark brown, Silty to Clayey, fine to medium SAND with gravel and cobbles up to 8 inches in diameter -Becomes moist and sandier at 2 feet			
2				SM/SC/ GM/GC				
4	T178-1							
4	T178-2							
6								
8								
10					GRANITIC ROCK Moderately to highly weathered, yellowish gray, weak, GRANITIC ROCK -Becomes slightly weathered and strong at 11 feet -Excavates to: Silty, fine to medium SAND			
12					BOTTOM OF TRENCH AT 12 FEET			

Figure A-83, Log of Trench T178

FRNC1

SAMPLE SYMBOLS		... SAMPLING UNSUCCESSFUL		... STANDARD PENETRATION TEST		... DRIVE SAMPLE (UNDISTURBED)
		... DISTURBED OR BAG SAMPLE		... CHUNK SAMPLE		... WATER TABLE OR SEEPAGE

NOTE: THE LOG OF SUBSURFACE CONDITIONS SHOWN HEREON APPLIES ONLY AT THE SPECIFIC BORING OR TRENCH LOCATION AND AT THE DATE INDICATED. IT IS NOT WARRANTED TO BE REPRESENTATIVE OF SUBSURFACE CONDITIONS AT OTHER LOCATIONS AND TIMES.

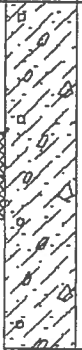
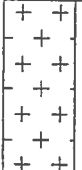
DEPTH IN FEET	SAMPLE NO.	LITHOLOGY	GROUNDWATER	SOIL CLASS (USCS)	TRENCH T179		PENETRATION RESISTANCE (BLOWS/FT.)	DRY DENSITY (P.C.F.)	MOISTURE CONTENT (%)
					ELEV. (MSL.)	DATE COMPLETED			
					ELEV. (MSL.)	585	DATE COMPLETED	7/13/95	
					EQUIPMENT	JD 555			
MATERIAL DESCRIPTION									
0				SM/SC	TOPSOIL Loose, dry to damp, medium brown, Silty to Clayey, fine to medium SAND with few gravel				
2									
4	T179-1			CL	COLLUVIUM/LANDSLIDE DEBRIS Soft, moist, olive brown, Silty CLAY with trace of fine to medium sand; punky appearance				
6					-Becomes firm, siltstone/claystone with black and orange oxide staining at 5.5 feet				
8	T179-2				-Becomes medium brown to dark brown with caliche stringers from 6.5 to 8 feet				
10				SC	Dense, damp, dark olive green to dark olive brown, Clayey, fine to medium SANDSTONE; blocky with disturbed appearance				
12	T179-3			SM/SC	FRIARS FORMATION Dense to very dense, damp, light grayish brown, Silty to Clayey, fine to medium SANDSTONE				
BOTTOM OF TRENCH AT 12 FEET									

Figure A-84, Log of Trench T179

FRNC1

SAMPLE SYMBOLS	□ ... SAMPLING UNSUCCESSFUL	■ ... STANDARD PENETRATION TEST	■ ... DRIVE SAMPLE (UNDISTURBED)
	⊗ ... DISTURBED OR BAG SAMPLE	▣ ... CHUNK SAMPLE	▽ ... WATER TABLE OR SEEPAGE

NOTE: THE LOG OF SUBSURFACE CONDITIONS SHOWN HEREON APPLIES ONLY AT THE SPECIFIC BORING OR TRENCH LOCATION AND AT THE DATE INDICATED. IT IS NOT WARRANTED TO BE REPRESENTATIVE OF SUBSURFACE CONDITIONS AT OTHER LOCATIONS AND TIMES.

DEPTH IN FEET	SAMPLE NO.	LITHOLOGY	GROUNDWATER	SOIL CLASS (USCS)	TRENCH T180		PENETRATION RESISTANCE (BLOWS/FT.)	DRY DENSITY (P.C.F.)	MOISTURE CONTENT (%)
					ELEV. (MSL.) <u>565</u>	DATE COMPLETED <u>7/13/95</u>			
					EQUIPMENT <u>JD 555</u>				
MATERIAL DESCRIPTION									
0				SM/SC	TOPSOIL Loose, dry to damp, medium brown, Silty to Clayey, fine to medium SAND with gravel and cobble				
2				GM/GC	COLLUVIUM/LANDSLIDE DEBRIS Medium dense, damp to moist, yellowish gray to orangish brown, Silty to Clayey, fine to medium Sandy GRAVEL/COBBLE CONGLOMERATE; no cementation, appears disturbed, digs easy				
4									
6	T180-1								
8									
10									
12	T180-2			SM	FRIARS FORMATION Dense, damp to moist, grayish brown, Silty, fine to medium SANDSTONE; occasional cobble				
					BOTTOM OF TRENCH AT 13 FEET				

Figure A-85, Log of Trench T180

FRNC1

SAMPLE SYMBOLS	... SAMPLING UNSUCCESSFUL	... STANDARD PENETRATION TEST	... DRIVE SAMPLE (UNDISTURBED)
	... DISTURBED OR BAG SAMPLE	... CHUNK SAMPLE	... WATER TABLE OR SEEPAGE

NOTE: THE LOG OF SUBSURFACE CONDITIONS SHOWN HEREON APPLIES ONLY AT THE SPECIFIC BORING OR TRENCH LOCATION AND AT THE DATE INDICATED. IT IS NOT WARRANTED TO BE REPRESENTATIVE OF SUBSURFACE CONDITIONS AT OTHER LOCATIONS AND TIMES.

DEPTH IN FEET	SAMPLE NO.	LITHOLOGY	GROUNDWATER	SOIL CLASS (USCS)	TRENCH T181		PENETRATION RESISTANCE (BLOWS/FT.)	DRY DENSITY (P.C.F.)	MOISTURE CONTENT (%)
					ELEV. (MSL.)	DATE COMPLETED			
					ELEV. (MSL.)	568	DATE COMPLETED	7/13/95	
					EQUIPMENT	JD 555			
MATERIAL DESCRIPTION									
0				CL	COLLUVIUM Firm, damp to moist, dark brown, fine to medium Sandy CLAY with few cobbles				
2			-Becomes orangish brown at 3 feet						
4				SM/SC	FRIARS FORMATION Dense, damp, light grayish brown, Silty to Clayey, fine to medium SANDSTONE; slightly cemented				
6		-Few cobbles from 7 to 8 feet							
8					BOTTOM OF TRENCH AT 9 FEET				

Figure A-86, Log of Trench T181

FRNC1

SAMPLE SYMBOLS	<input type="checkbox"/>	... SAMPLING UNSUCCESSFUL	<input type="checkbox"/>	... STANDARD PENETRATION TEST	<input type="checkbox"/>	... DRIVE SAMPLE (UNDISTURBED)
	<input checked="" type="checkbox"/>	... DISTURBED OR BAG SAMPLE	<input checked="" type="checkbox"/>	... CHUNK SAMPLE		... WATER TABLE OR SEEPAGE

NOTE: THE LOG OF SUBSURFACE CONDITIONS SHOWN HEREON APPLIES ONLY AT THE SPECIFIC BORING OR TRENCH LOCATION AND AT THE DATE INDICATED. IT IS NOT WARRANTED TO BE REPRESENTATIVE OF SUBSURFACE CONDITIONS AT OTHER LOCATIONS AND TIMES.



DEPTH IN FEET	SAMPLE NO.	LITHOLOGY	GROUNDWATER	TRENCH T182		PENETRATION RESISTANCE (BLOWS/FT.)	DRY DENSITY (P.C.F.)	MOISTURE CONTENT (%)
				ELEV. (MSL.) <u>565</u>	DATE COMPLETED <u>7/13/95</u>			
				SOIL CLASS (USCS)	EQUIPMENT <u>JD 555</u>			
MATERIAL DESCRIPTION								
0				CL	TOPSOIL Firm, damp to moist, dark brown, fine to medium Sandy CLAY, occasional gravel			
2					GRANITIC ROCK Slightly weathered, orangish gray, strong, GRANITIC ROCK -Excavates to: Silty, fine to coarse SAND			
4								
BOTTOM OF TRENCH AT 5.5 FEET								

Figure A-87, Log of Trench T182

FRNC1

SAMPLE SYMBOLS	<input type="checkbox"/> ... SAMPLING UNSUCCESSFUL	<input type="checkbox"/> ... STANDARD PENETRATION TEST	<input checked="" type="checkbox"/> ... DRIVE SAMPLE (UNDISTURBED)
	<input checked="" type="checkbox"/> ... DISTURBED OR BAG SAMPLE	<input checked="" type="checkbox"/> ... CHUNK SAMPLE	 ... WATER TABLE OR SEEPAGE

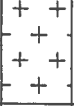
NOTE: THE LOG OF SUBSURFACE CONDITIONS SHOWN HEREON APPLIES ONLY AT THE SPECIFIC BORING OR TRENCH LOCATION AND AT THE DATE INDICATED. IT IS NOT WARRANTED TO BE REPRESENTATIVE OF SUBSURFACE CONDITIONS AT OTHER LOCATIONS AND TIMES.

PROJECT NO. 05254-52-02







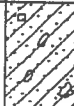
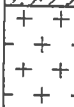

DEPTH IN FEET	SAMPLE NO.	LITHOLOGY	GROUNDWATER	SOIL CLASS (USCS)	TRENCH T183		PENETRATION RESISTANCE (BLOWS/FT.)	DRY DENSITY (P.C.F.)	MOISTURE CONTENT (%)
					ELEV. (MSL.) <u>585</u>	DATE COMPLETED <u>7/14/95</u>			
					EQUIPMENT <u>JD 555</u>				
MATERIAL DESCRIPTION									
0				CL	TOPSOIL Soft to firm, damp to moist, dark brown, fine to medium Sandy CLAY with few gravel				
2					GRANITIC ROCK Slightly to moderately weathered, dark orangish gray, strong, GRANITIC ROCK -Excavates to: Silty, fine to coarse SAND				
4									
6									
BOTTOM OF TRENCH AT 6.5 FEET									

Figure A-88, Log of Trench T183

FRNC1

SAMPLE SYMBOLS		... SAMPLING UNSUCCESSFUL		... STANDARD PENETRATION TEST		... DRIVE SAMPLE (UNDISTURBED)
		... DISTURBED OR BAG SAMPLE		... CHUNK SAMPLE		... WATER TABLE OR SEEPAGE

NOTE: THE LOG OF SUBSURFACE CONDITIONS SHOWN HEREON APPLIES ONLY AT THE SPECIFIC BORING OR TRENCH LOCATION AND AT THE DATE INDICATED. IT IS NOT WARRANTED TO BE REPRESENTATIVE OF SUBSURFACE CONDITIONS AT OTHER LOCATIONS AND TIMES.



DEPTH IN FEET	SAMPLE NO.	LITHOLOGY	GROUNDWATER	TRENCH T184		PENETRATION RESISTANCE (BLOWS/FT.)	DRY DENSITY (P.C.F.)	MOISTURE CONTENT (%)
				ELEV. (MSL.) <u>580</u>	DATE COMPLETED <u>7/14/95</u>			
				SOIL CLASS (USCS)	EQUIPMENT <u>JD 555</u>			
MATERIAL DESCRIPTION								
0				CL/GC	ALLUVIUM Soft to firm, damp to moist, dark brown to dark reddish brown, fine to medium Sandy CLAY with gravel and cobbles up to 6 inches in diameter			
2								
4					GRANITIC ROCK Slightly weathered, dark orange to black, strong, GRANITIC ROCK -Excavates to: Silty, fine to coarse SAND with 2 inch to 5 inch fragments			
6					BOTTOM OF TRENCH AT 6 FEET			

Figure A-89, Log of Trench T184

FRNC1

SAMPLE SYMBOLS	<input type="checkbox"/> ... SAMPLING UNSUCCESSFUL	<input type="checkbox"/> ... STANDARD PENETRATION TEST	<input type="checkbox"/> ... DRIVE SAMPLE (UNDISTURBED)
	<input checked="" type="checkbox"/> ... DISTURBED OR BAG SAMPLE	<input type="checkbox"/> ... CHUNK SAMPLE	 ... WATER TABLE OR SEEPAGE

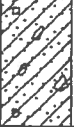
NOTE: THE LOG OF SUBSURFACE CONDITIONS SHOWN HEREON APPLIES ONLY AT THE SPECIFIC BORING OR TRENCH LOCATION AND AT THE DATE INDICATED. IT IS NOT WARRANTED TO BE REPRESENTATIVE OF SUBSURFACE CONDITIONS AT OTHER LOCATIONS AND TIMES.

PROJECT NO. 05254-52-02

DEPTH IN FEET	SAMPLE NO.	LITHOLOGY	GROUNDWATER	SOIL CLASS (USCS)	TRENCH T185		PENETRATION RESISTANCE (BLOWS/FT.)	DRY DENSITY (P.C.F.)	MOISTURE CONTENT (%)
					ELEV. (MSL.)	DATE COMPLETED			
					ELEV. (MSL.)	590	DATE COMPLETED	7/14/95	
					EQUIPMENT	JD 555			
MATERIAL DESCRIPTION									
0				SM/SC GM/GC	ALLUVIUM Loose, damp to moist, medium brown, Silty to Clayey, fine to medium SAND with gravel and cobbles up to 5 inches in diameter -Slight to moderate seepage and moderate caving at 2 feet -Increase in gravel and cobbles at 2 feet				
2				ML/CL	WEATHERED FRIARS FORMATION Soft, moist to wet, olive green to olive brown, Clayey SILT to Silty CLAY				
4				SC	FRIARS FORMATION Dense, damp, olive brown, Clayey, fine to medium SANDSTONE				
6									
8									
10									
12					BOTTOM OF TRENCH AT 12 FEET TRENCH LOGGED FROM SURFACE				

Figure A-90, Log of Trench T185

FRNC1

SAMPLE SYMBOLS	<input type="checkbox"/>	... SAMPLING UNSUCCESSFUL	<input type="checkbox"/>	... STANDARD PENETRATION TEST	<input type="checkbox"/>	... DRIVE SAMPLE (UNDISTURBED)
	<input checked="" type="checkbox"/>	... DISTURBED OR BAG SAMPLE	<input checked="" type="checkbox"/>	... CHUNK SAMPLE		... WATER TABLE OR SEEPAGE

NOTE: THE LOG OF SUBSURFACE CONDITIONS SHOWN HEREON APPLIES ONLY AT THE SPECIFIC BORING OR TRENCH LOCATION AND AT THE DATE INDICATED. IT IS NOT WARRANTED TO BE REPRESENTATIVE OF SUBSURFACE CONDITIONS AT OTHER LOCATIONS AND TIMES.

DEPTH IN FEET	SAMPLE NO.	LITHOLOGY	GROUNDWATER	SOTL CLASS (USCS)	TRENCH T186		PENETRATION RESISTANCE (BLOWS/FT.)	DRY DENSITY (P.C.F.)	MOISTURE CONTENT (%)
					ELEV. (MSL.) <u>608</u>	DATE COMPLETED <u>7/14/95</u>			
					EQUIPMENT <u>JD 555</u>				
MATERIAL DESCRIPTION									
0				SM	COLLUVIUM Loose, damp, medium brown, Silty, fine to medium SAND				
2				CL/GC	Firm, moist, medium brown to to orangish brown, fine to medium Sandy CLAY with gravel and cobble				
4									
6									
8				CL	WEATHERED FRIARS FORMATION Stiff, moist, orangish brown, fine to medium Sandy CLAYSTONE; moderately weathered				
10									
12				SC	FRIARS FORMATION Dense, damp to moist, orangish brown to brownish gray, Clayey, fine to medium SANDSTONE -Cobbles from from 11 to 12 feet				
					BOTTOM OF TRENCH AT 12 FEET				

Figure A-91, Log of Trench T186

FRNC1

SAMPLE SYMBOLS	<input type="checkbox"/>	... SAMPLING UNSUCCESSFUL	<input type="checkbox"/>	... STANDARD PENETRATION TEST	<input type="checkbox"/>	... DRIVE SAMPLE (UNDISTURBED)
	<input checked="" type="checkbox"/>	... DISTURBED OR BAG SAMPLE	<input checked="" type="checkbox"/>	... CHUNK SAMPLE	<input type="checkbox"/>	... WATER TABLE OR SEEPAGE

NOTE: THE LOG OF SUBSURFACE CONDITIONS SHOWN HEREON APPLIES ONLY AT THE SPECIFIC BORING OR TRENCH LOCATION AND AT THE DATE INDICATED. IT IS NOT WARRANTED TO BE REPRESENTATIVE OF SUBSURFACE CONDITIONS AT OTHER LOCATIONS AND TIMES.

DEPTH IN FEET	SAMPLE NO.	LITHOLOGY	GROUNDWATER	SOIL CLASS (USCS)	TRENCH T187		PENETRATION RESISTANCE (BLOWS/FT.)	DRY DENSITY (P.C.F.)	MOISTURE CONTENT (%)
					ELEV. (MSL.) <u>580</u>	DATE COMPLETED <u>7/14/95</u>			
					EQUIPMENT <u>JD 555</u>				
MATERIAL DESCRIPTION									
0				CL/GC	TOPSOIL Soft to firm, moist, dark brown, fine to medium Sandy CLAY with gravel and cobbles up to 5 inches in diameter				
2				CL	LANDSLIDE DEBRIS Soft, moist, olive brown to gray, Silty CLAY with fine to medium sand and gravel/cobbles; punky appearance				
4				ML/CL	Soft, moist, reddish brown, Clayey SILT to Silty CLAY, few gravel and cobbles (Paleosol ?)				
6					Soft, moist, reddish brown, Clayey SILT to Silty CLAY, few gravel and cobbles (Paleosol ?)				
8					GRANITIC ROCK Slightly weathered, dark orange to black, strong, GRANITIC ROCK -Excavates to: Silty, fine to coarse SAND with 1 inch to 5 inch fragments				
10					BOTTOM OF TRENCH AT 10 FEET				

Figure A-92, Log of Trench T187

FRNC1

SAMPLE SYMBOLS		... SAMPLING UNSUCCESSFUL		... STANDARD PENETRATION TEST		... DRIVE SAMPLE (UNDISTURBED)
		... DISTURBED OR BAG SAMPLE		... CHUNK SAMPLE		... WATER TABLE OR SEEPAGE

NOTE: THE LOG OF SUBSURFACE CONDITIONS SHOWN HEREON APPLIES ONLY AT THE SPECIFIC BORING OR TRENCH LOCATION AND AT THE DATE INDICATED. IT IS NOT WARRANTED TO BE REPRESENTATIVE OF SUBSURFACE CONDITIONS AT OTHER LOCATIONS AND TIMES.

DEPTH IN FEET	SAMPLE NO.	LITHOLOGY	GROUNDWATER	SOIL CLASS (USCS)	TRENCH T188		PENETRATION RESISTANCE (BLOWS/FT.)	DRY DENSITY (P.C.F.)	MOISTURE CONTENT (%)
					ELEV. (MSL.)	DATE COMPLETED			
					ELEV. (MSL.)	555	DATE COMPLETED	7/14/95	
					EQUIPMENT	JD 555			
MATERIAL DESCRIPTION									
0									
2	T188-1	[Diagonal Hatching]		CL/GC	ALLUVIUM Soft to firm, moist, dark orangish brown, fine to medium Sandy CLAY with gravel and cobbles up to 5 inches in diameter -Becomes firm to stiff and medium brown to grayish brown with fewer gravel and cobbles from 3 to 5 feet				
4									
6	T188-2								
8									
10		[Cross Hatching]			GRANITIC ROCK Slightly to moderately weathered, dark orange to black, moderately strong, GRANITIC ROCK -Excavates to: Silty, fine to coarse SAND with 1 inch fragments BOTTOM OF TRENCH AT 10 FEET				

Figure A-93, Log of Trench T188

FRNC1

SAMPLE SYMBOLS	<input type="checkbox"/> ... SAMPLING UNSUCCESSFUL	<input type="checkbox"/> ... STANDARD PENETRATION TEST	<input type="checkbox"/> ... DRIVE SAMPLE (UNDISTURBED)
	<input checked="" type="checkbox"/> ... DISTURBED OR BAG SAMPLE	<input type="checkbox"/> ... CHUNK SAMPLE	<input type="checkbox"/> ... WATER TABLE OR SEEPAGE

NOTE: THE LOG OF SUBSURFACE CONDITIONS SHOWN HEREON APPLIES ONLY AT THE SPECIFIC BORING OR TRENCH LOCATION AND AT THE DATE INDICATED. IT IS NOT WARRANTED TO BE REPRESENTATIVE OF SUBSURFACE CONDITIONS AT OTHER LOCATIONS AND TIMES.

PROJECT NO. 05254-52-02

DEPTH IN FEET	SAMPLE NO.	LITHOLOGY	GROUNDWATER	SOIL CLASS (USCS)	TRENCH T189		PENETRATION RESISTANCE (BLOWS/FT.)	DRY DENSITY (P.C.F.)	MOISTURE CONTENT (%)
					ELEV. (MSL.) <u>575</u>	DATE COMPLETED <u>7/14/95</u>			
					EQUIPMENT <u>JD 555</u>				
MATERIAL DESCRIPTION									
0				CL	TOPSOIL Soft, damp to moist, dark brown, fine to medium Sandy CLAY with gravel and cobbles				
2				GM/GC	LANDSLIDE DEBRIS Soft, moist, olive green to olive brown, Clayey SILT with gravel and cobble; appears punky and disturbed, digs easy				
4									
6									
8									
10				CL	Firm, moist, dark brown, Silty CLAY with some fine to medium sand and gravel (Paleosol ?)				
12				ML/CL	Soft to firm, moist, olive brown to gray, Clayey SILT to Silty CLAY with some fine to medium sand				
BOTTOM OF TRENCH AT 12 FEET									

Figure A-94, Log of Trench T189

FRNC1

SAMPLE SYMBOLS	<input type="checkbox"/>	... SAMPLING UNSUCCESSFUL	<input type="checkbox"/>	... STANDARD PENETRATION TEST	<input type="checkbox"/>	... DRIVE SAMPLE (UNDISTURBED)
	<input checked="" type="checkbox"/>	... DISTURBED OR BAG SAMPLE	<input type="checkbox"/>	... CHUNK SAMPLE	<input type="checkbox"/>	... WATER TABLE OR SEEPAGE

NOTE: THE LOG OF SUBSURFACE CONDITIONS SHOWN HEREON APPLIES ONLY AT THE SPECIFIC BORING OR TRENCH LOCATION AND AT THE DATE INDICATED. IT IS NOT WARRANTED TO BE REPRESENTATIVE OF SUBSURFACE CONDITIONS AT OTHER LOCATIONS AND TIMES.

DEPTH IN FEET	SAMPLE NO.	LITHOLOGY	GROUNDWATER	TRENCH T190		PENETRATION RESISTANCE (BLOWS/FT.)	DRY DENSITY (P.C.F.)	MOISTURE CONTENT (%)
				ELEV. (MSL.) 560	DATE COMPLETED 7/14/95			
				EQUIPMENT				
				JD 555				
MATERIAL DESCRIPTION								
0				CL/GC	ALLUVIUM Soft to firm, moist, dark brown, fine to medium Sandy CLAY with gravel and cobbles			
2								
4								
6				SC	Loose, wet, dark brown, Clayey, fine to coarse SAND			
8					-Moderate seepage and caving at 8 feet			
10								
12					GRANITIC ROCK Moderately to highly weathered, orangish brown, weak, GRANITIC ROCK			
14					BOTTOM OF TRENCH AT 14 FEET TRENCH LOGGED FROM SURFACE			

Figure A-95, Log of Trench T190

FRNC1

SAMPLE SYMBOLS	... SAMPLING UNSUCCESSFUL	... STANDARD PENETRATION TEST	... DRIVE SAMPLE (UNDISTURBED)
	... DISTURBED OR BAG SAMPLE	... CHUNK SAMPLE	... WATER TABLE OR SEEPAGE

NOTE: THE LOG OF SUBSURFACE CONDITIONS SHOWN HEREON APPLIES ONLY AT THE SPECIFIC BORING OR TRENCH LOCATION AND AT THE DATE INDICATED. IT IS NOT WARRANTED TO BE REPRESENTATIVE OF SUBSURFACE CONDITIONS AT OTHER LOCATIONS AND TIMES.

TRENCH T191					PENETRATION RESISTANCE (BLOWS/FT.)	DRY DENSITY (P.C.F.)	MOISTURE CONTENT (%)
DEPTH IN FEET	SAMPLE NO.	LITHOLOGY	GROUNDWATER	SOIL CLASS (USCS)			
ELEV. (MSL.) <u>575</u> DATE COMPLETED <u>7/14/95</u>							
EQUIPMENT <u>JD 555</u>							
MATERIAL DESCRIPTION							
0				SM/SC	COLLUVIUM/LANDSLIDE DEBRIS Loose, damp, medium brown, Silty to Clayey, fine to medium SAND, few small cobbles		
2				CL/GC	Medium dense, moist, olive brown to gray, fine to medium Sandy CLAY with gravel and cobble; appears disturbed, zones of slight cementation		
4							
6							
8					SM/SC	Medium dense to dense, moist, dark brown, Silty to Clayey fine to medium SAND (Paleosol ?)	
10							
12				CL	Soft to firm, moist, olive green to green, Silty CLAYSTONE (Weathered Friars Formation ?), waxy		
14				CL	FRIARS FORMATION ? Firm to stiff, moist, olive brown, fine to medium Sandy CLAY with gravel and cobble -Slight density increase at 15 feet		
16					BOTTOM OF TRENCH AT 16 FEET TRENCH LOGGED FROM SURFACE BELOW 9 FEET		

Figure A-96, Log of Trench T191

FRNC1

SAMPLE SYMBOLS	<input type="checkbox"/>	... SAMPLING UNSUCCESSFUL	<input type="checkbox"/>	... STANDARD PENETRATION TEST	<input type="checkbox"/>	... DRIVE SAMPLE (UNDISTURBED)
	<input checked="" type="checkbox"/>	... DISTURBED OR BAG SAMPLE	<input checked="" type="checkbox"/>	... CHUNK SAMPLE	<input checked="" type="checkbox"/>	... WATER TABLE OR SEEPAGE

NOTE: THE LOG OF SUBSURFACE CONDITIONS SHOWN HEREON APPLIES ONLY AT THE SPECIFIC BORING OR TRENCH LOCATION AND AT THE DATE INDICATED. IT IS NOT WARRANTED TO BE REPRESENTATIVE OF SUBSURFACE CONDITIONS AT OTHER LOCATIONS AND TIMES.

DEPTH IN FEET	SAMPLE NO.	LITHOLOGY	GROUNDWATER	SOIL CLASS (USCS)	TRENCH T192		PENETRATION RESISTANCE (BLOWS/FT.)	DRY DENSITY (P.C.F.)	MOISTURE CONTENT (%)
					ELEV. (MSL.)	DATE COMPLETED			
					ELEV. (MSL.)	565	DATE COMPLETED	7/14/95	
					EQUIPMENT	JD 555			
MATERIAL DESCRIPTION									
0									
2				SM/SC GM/GC	ALLUVIUM Loose, damp to moist, medium brown to dark brown, Silty to Clayey, fine to coarse SAND with gravel and cobbles up to 6 inches in diameter				
4	T192-1								
6				SM/SC	FRIARS FORMATION Medium dense, moist, orangish brown, Silty to Clayey, fine to medium SANDSTONE				
	T192-1			SM	Very dense, dry to damp, gray, Silty, fine to medium SANDSTONE; highly cemented -Refusal with backhoe				
					REFUSAL AT 7.5 FEET				

Figure A-97, Log of Trench T192

FRNC1

SAMPLE SYMBOLS		... SAMPLING UNSUCCESSFUL		... STANDARD PENETRATION TEST		... DRIVE SAMPLE (UNDISTURBED)
		... DISTURBED OR BAG SAMPLE		... CHUNK SAMPLE		... WATER TABLE OR SEEPAGE

NOTE: THE LOG OF SUBSURFACE CONDITIONS SHOWN HEREON APPLIES ONLY AT THE SPECIFIC BORING OR TRENCH LOCATION AND AT THE DATE INDICATED. IT IS NOT WARRANTED TO BE REPRESENTATIVE OF SUBSURFACE CONDITIONS AT OTHER LOCATIONS AND TIMES.







DEPTH IN FEET	SAMPLE NO.	LITHOLOGY	GROUNDWATER	SOIL CLASS (USCS)	TRENCH T193		PENETRATION RESISTANCE (BLOWS/FT.)	DRY DENSITY (P.C.F.)	MOISTURE CONTENT (%)
					ELEV. (MSL.) 590	DATE COMPLETED 7/14/95			
					EQUIPMENT				
					JD 555				
MATERIAL DESCRIPTION									
0									
2				CL	COLLUVIUM Firm, moist, dark brown, fine to medium Sandy CLAY, few gravel and cobbles				
4									
6				CL	FRIARS FORMATION Medium dense to dense, damp, olive green to olive brown, Silty CLAYSTONE; blocky				
8				SC/SM	Dense, damp, olive green, Clayey to Silty, fine to medium SANDSTONE; blocky				
					BOTTOM OF TRENCH AT 8 FEET				

Figure A-98, Log of Trench T193

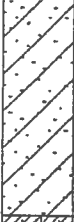
FRNC1

SAMPLE SYMBOLS		... SAMPLING UNSUCCESSFUL		... STANDARD PENETRATION TEST		... DRIVE SAMPLE (UNDISTURBED)
		... DISTURBED OR BAG SAMPLE		... CHUNK SAMPLE		... WATER TABLE OR SEEPAGE

NOTE: THE LOG OF SUBSURFACE CONDITIONS SHOWN HEREON APPLIES ONLY AT THE SPECIFIC BORING OR TRENCH LOCATION AND AT THE DATE INDICATED. IT IS NOT WARRANTED TO BE REPRESENTATIVE OF SUBSURFACE CONDITIONS AT OTHER LOCATIONS AND TIMES.

DEPTH IN FEET	SAMPLE NO.	LITHOLOGY	GROUNDWATER	SOIL CLASS (USCS)	TRENCH T194		PENETRATION RESISTANCE (BLOWS/FT.)	DRY DENSITY (P.C.F.)	MOISTURE CONTENT (%)
					ELEV. (MSL.)	DATE COMPLETED			
					ELEV. (MSL.)	590	DATE COMPLETED	7/14/95	
					EQUIPMENT	JD 555			
MATERIAL DESCRIPTION									
0				CL/GC	COLLUVIUM Soft to firm, moist, dark brown, fine to coarse Sandy CLAY with gravel and cobbles up to 15 inches in diameter				
2									
4									
6				SM	FRIARS FORMATION Dense to very dense, damp to moist, olive green to greenish gray, Silty, fine to medium SANDSTONE				
8									
BOTTOM OF TRENCH AT 8 FEET									

Figure A-99, Log of Trench T194

FRNC1

SAMPLE SYMBOLS	<input type="checkbox"/>	... SAMPLING UNSUCCESSFUL	<input type="checkbox"/>	... STANDARD PENETRATION TEST	<input type="checkbox"/>	... DRIVE SAMPLE (UNDISTURBED)
	<input checked="" type="checkbox"/>	... DISTURBED OR BAG SAMPLE	<input checked="" type="checkbox"/>	... CHUNK SAMPLE		... WATER TABLE OR SEEPAGE

NOTE: THE LOG OF SUBSURFACE CONDITIONS SHOWN HEREON APPLIES ONLY AT THE SPECIFIC BORING OR TRENCH LOCATION AND AT THE DATE INDICATED. IT IS NOT WARRANTED TO BE REPRESENTATIVE OF SUBSURFACE CONDITIONS AT OTHER LOCATIONS AND TIMES.

DEPTH IN FEET	SAMPLE NO.	LITHOLOGY	GROUNDWATER	SOIL CLASS (USCS)	TRENCH T195		PENETRATION RESISTANCE (BLOWS/FT.)	DRY DENSITY (P.C.F.)	MOISTURE CONTENT (%)
					ELEV. (MSL.) 590	DATE COMPLETED 7/14/95			
					EQUIPMENT JD 555				
MATERIAL DESCRIPTION									
0				CL	TOPSOIL Soft, damp to moist, dark brown, fine to medium Sandy CLAY with gravel and cobble				
2				CL	LANDSLIDE DEBRIS Soft, moist, orangish brown, fine to medium Sandy CLAY with gravel and cobble				
4				CL					
6									
8				CL/ML	Soft to firm, moist, olive green, Silty CLAY to Clayey SILT				
10				CL	FRIARS FORMATION ? Medium dense, moist, olive green, fine to medium Sandy CLAYSTONE -Becomes cobbly at 11 feet				
12					BOTTOM OF TRENCH AT 12 FEET TRENCH LOGGED FROM SURFACE BELOW 9 FEET				

Figure A-100, Log of Trench T195

FRNC1

SAMPLE SYMBOLS	... SAMPLING UNSUCCESSFUL	... STANDARD PENETRATION TEST	... DRIVE SAMPLE (UNDISTURBED)
	... DISTURBED OR BAG SAMPLE	... CHUNK SAMPLE	... WATER TABLE OR SEEPAGE

NOTE: THE LOG OF SUBSURFACE CONDITIONS SHOWN HEREON APPLIES ONLY AT THE SPECIFIC BORING OR TRENCH LOCATION AND AT THE DATE INDICATED. IT IS NOT WARRANTED TO BE REPRESENTATIVE OF SUBSURFACE CONDITIONS AT OTHER LOCATIONS AND TIMES.

DEPTH IN FEET	SAMPLE NO.	LITHOLOGY	GROUNDWATER	TRENCH T196		PENETRATION RESISTANCE (BLOWS/FT.)	DRY DENSITY (P.C.F.)	MOISTURE CONTENT (%)	
				SOIL CLASS (USCS)	ELEV. (MSL.) <u>575</u> DATE COMPLETED <u>7/14/95</u> EQUIPMENT <u>JD 555</u>				
MATERIAL DESCRIPTION									
0				CL/GC	ALLUVIUM Soft to firm, moist, medium brown, fine to medium Sandy CLAY with gravel and cobbles up to 8 inches in diameter				
2						Soft to firm, moist, olive green, mottled with gray and orange, Silty CLAY with cobbles			
4					CL/GC				
6									
8				CL/SC	FRIARS FORMATION Dense, damp to moist, olive brown, fine to medium Sandy CLAYSTONE/Clayey, fine to medium SANDSTONE				
BOTTOM OF TRENCH AT 9 FEET									

Figure A-101, Log of Trench T196

FRNC1

SAMPLE SYMBOLS	<input type="checkbox"/>	... SAMPLING UNSUCCESSFUL	<input type="checkbox"/>	... STANDARD PENETRATION TEST	<input type="checkbox"/>	... DRIVE SAMPLE (UNDISTURBED)
	<input checked="" type="checkbox"/>	... DISTURBED OR BAG SAMPLE	<input type="checkbox"/>	... CHUNK SAMPLE		... WATER TABLE OR SEEPAGE

NOTE: THE LOG OF SUBSURFACE CONDITIONS SHOWN HEREON APPLIES ONLY AT THE SPECIFIC BORING OR TRENCH LOCATION AND AT THE DATE INDICATED. IT IS NOT WARRANTED TO BE REPRESENTATIVE OF SUBSURFACE CONDITIONS AT OTHER LOCATIONS AND TIMES.





DEPTH IN FEET	SAMPLE NO.	LITHOLOGY	GROUNDWATER	SOIL CLASS (USCS)	TRENCH T197		PENETRATION RESISTANCE (BLOWS/FT.)	DRY DENSITY (P.C.F.)	MOISTURE CONTENT (%)
					ELEV. (MSL.) <u>602</u>	DATE COMPLETED <u>7/14/95</u>			
					EQUIPMENT <u>JD 555</u>				
MATERIAL DESCRIPTION									
0				CL	TOPSOIL Soft to firm, damp to moist, medium brown, fine to medium Sandy CLAY with gravel and cobbles				
2				GC	LANDSLIDE DEBRIS (BLOCK ?) Dense, damp to moist, grayish brown to yellowish brown, Clayey, fine to medium Sandy GRAVEL/COBBLE CONGLOMERATE				
4									
6									
8									
10				CL	Medium dense, damp to moist, olive green, Silty CLAYSTONE with trace of fine sand; waxy, black oxide staining				
12					BOTTOM OF TRENCH AT 12 FEET				

Figure A-102, Log of Trench T197

FRNC1

SAMPLE SYMBOLS	 ... SAMPLING UNSUCCESSFUL	 ... STANDARD PENETRATION TEST	 ... DRIVE SAMPLE (UNDISTURBED)
	 ... DISTURBED OR BAG SAMPLE	 ... CHUNK SAMPLE	 ... WATER TABLE OR SEEPAGE

NOTE: THE LOG OF SUBSURFACE CONDITIONS SHOWN HEREON APPLIES ONLY AT THE SPECIFIC BORING OR TRENCH LOCATION AND AT THE DATE INDICATED. IT IS NOT WARRANTED TO BE REPRESENTATIVE OF SUBSURFACE CONDITIONS AT OTHER LOCATIONS AND TIMES.

APPENDIX

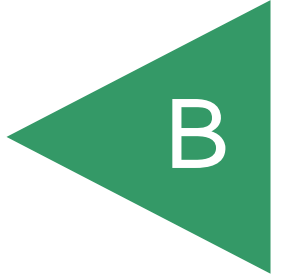

APPENDIX B

AIR-TRACK BORING LOGS (2005)

FOR

**FANITA RANCH
FANITA COMMONS, ORCHARD VILLAGE AND VINEYARD VILLAGE
SANTEE, CALIFORNIA**

PROJECT NO. 05254-32-18A

APPENDIX B

FIELD INVESTIGATION

The scope of our services consisted of drilling hydraulic rotary percussion borings (generically referenced herein as air-track borings) in the areas where significant excavations are proposed. Concentrated rock outcroppings precluded access to several proposed excavation areas. The borings were advanced using an Ingersoll Rand ECM-370 drill rig equipped with a 3-inch and 4-inch drill bit (3-inch for Stadium Conglomerate and 4-inch for granitic/gabbroic rock). A total of 52 borings were drilled between September 6 and 15, 2005. The air-track borings, in general, were advanced to approximately 10 feet below proposed finish grade of the previous tentative map, or to a maximum depth of 70 feet. Several borings were terminated before reaching the proposed depth of excavation due to collapsing holes within the Stadium Conglomerate. Geologic mapping presented in the referenced reports and the approximate locations of the air-track borings are shown on the Geologic Map.

Drill penetration rates were used to evaluate rock rippability and to estimate the depth at which difficult excavation will occur. A frequently used guideline to equate rock rippability to drill penetration rate is that a penetration rate of approximately 0 to 20 seconds per foot (spf) generally indicates rippable material, 20 to 30 spf indicates marginally to non-rippable material, and greater than 30 spf indicates non-rippable rock. These general guidelines are typically based on drill rates using a rotary percussion drill rig similar to an Ingersoll Rand ECM 360 with a 3½-inch drill bit.

The penetration rates (recorded in seconds per foot) for each air track boring are presented in Appendix B, Figures A-1 through A-52. Prospective contractors should use their own judgment to identify the penetration rate boundary between productive and non-productive ripping, and rippable and non-rippable rock.

The air-track borings were either advanced entirely in Stadium Conglomerate, granitic/gabbroic rock or a combination of these formations. Groundwater conditions were not encountered in any of the exploratory excavations. The table below indicates the geologic material(s) encountered in each boring based on our observation of the cuttings.

Geologic Formation	Air-Track Boring No.
Stadium Conglomerate	AT-1 through AT-24, AT-30, AT-31, AT-33 through AT-40
Granitic/gabbroic Rock	AT-25 through AT-27, AT-29, AT-41 through AT-52
Stadium Conglomerate/ Granitic-Gabbroic Rock	AT-28 (Stadium Conglomerate upper approximately 22 feet) AT-32 (Stadium Conglomerate upper approximately 47 feet)

Stadium Conglomerate unconformably overlies the granitic/gabbroic rock within the property and is exposed at various elevations along the ground surface in Vineyard Village (easternmost approximately two-thirds). The contact between these units can occur at variable elevations which can impact project grading costs when rock is encountered in areas expected to be Stadium Conglomerate assuming the contact is horizontal.

Based on this study, it is expected that the majority of many of the significant excavations within the development will encounter generally rippable Stadium Conglomerate materials. This is evidenced by Boring Nos. AT-1 through AT-24, AT-30, AT-31, and AT-33 through AT-40 which encountered Stadium Conglomerate the entire length of the boring. It should be noted, however, that the maximum capable drilling depth was 70 feet and several of the proposed excavations within the study area exceed the maximum drilling depth. It is, therefore, possible that hard granitic materials could still be encountered near the base of some of the proposed excavations.

It has been our experience that moderately heavy to heavy ripping will be required during grading within the Stadium Conglomerate due to randomly occurring highly cemented zones. The air-track borings performed within this unit indicate somewhat variable penetration rates, however, we understand that air percussion methods used to evaluate rippability in Stadium Conglomerate are unreliable due to several factors (e.g. cobble size, cobble percentage, hole collapse, etc.). Based on our observations of the ground surface during this study, a high percentage of cobbles and boulders are present within this unit which could impact the grading cost.

Granitic and gabbroic rock materials are exposed in a portion of Vineyard Village and in the northeastern portion of Orchard Village. These units have a variable weathering pattern ranging from completely weathered to outcrops of fresh, extremely strong hard rock. Rock rippability is a function of natural weathering processes which can vary vertically and horizontally over short distances depending on jointing, fracturing and/or mineralogic discontinuities within the bedrock. This is demonstrated by the penetration rates recorded in nearby Boring Nos. AT-26, AT-27, AT-47, and AT-48.

Proposed excavations within the granitic rock will likely require very difficult ripping and/or blasting as excavations are extended beyond the rippable weathered mantle. Based on a penetration rate of 20 spf, the thickness of the rippable granitic rock mantle is estimated to vary between 3 feet and 25 feet. Heavy ripping and/or blasting should also be anticipated in areas of concentrated rock outcroppings (see Figures 2 and 3). Estimates of the anticipated volume of hard rock materials generated from proposed excavations should be evaluated based on the information from each boring and a drill penetration rate criteria acceptable to the contractor. Roadway/utility corridor and lot undercutting criteria should also be considered when calculating the volume of hard rock. Proposed cuts in hard rock areas can be expected to generate oversized fragments (rocks greater than 12 inches in dimension) which will necessitate typical hard rock handling and placement procedures during grading operations.

AIR TRACK BORING AT-1
Elevation - 1030 Feet (MSL)



GEOCON
INCORPORATED

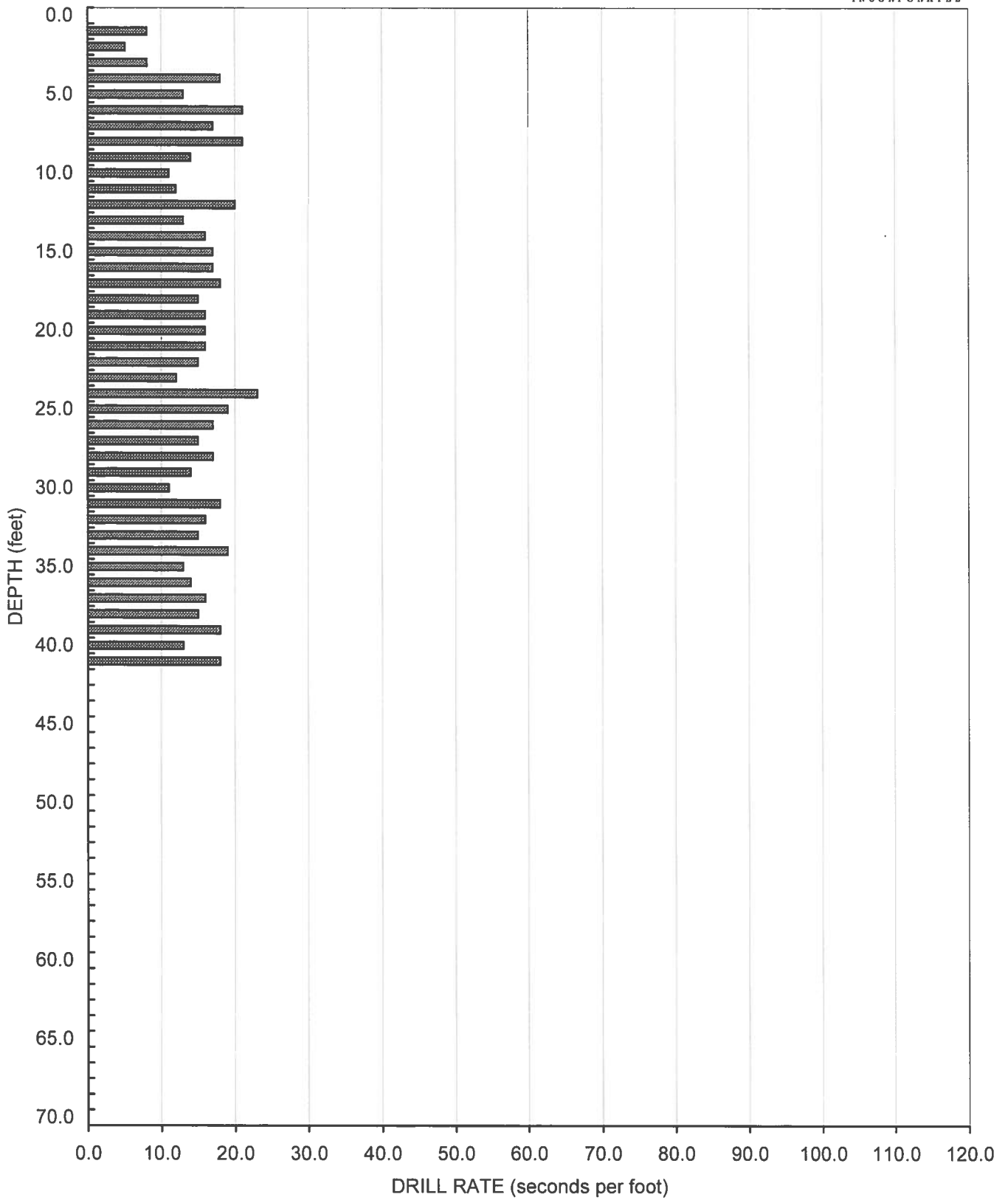

AIR TRACK BORING AT-2
Elevation - 1037 Feet (MSL)



GEOCON
INCORPORATED

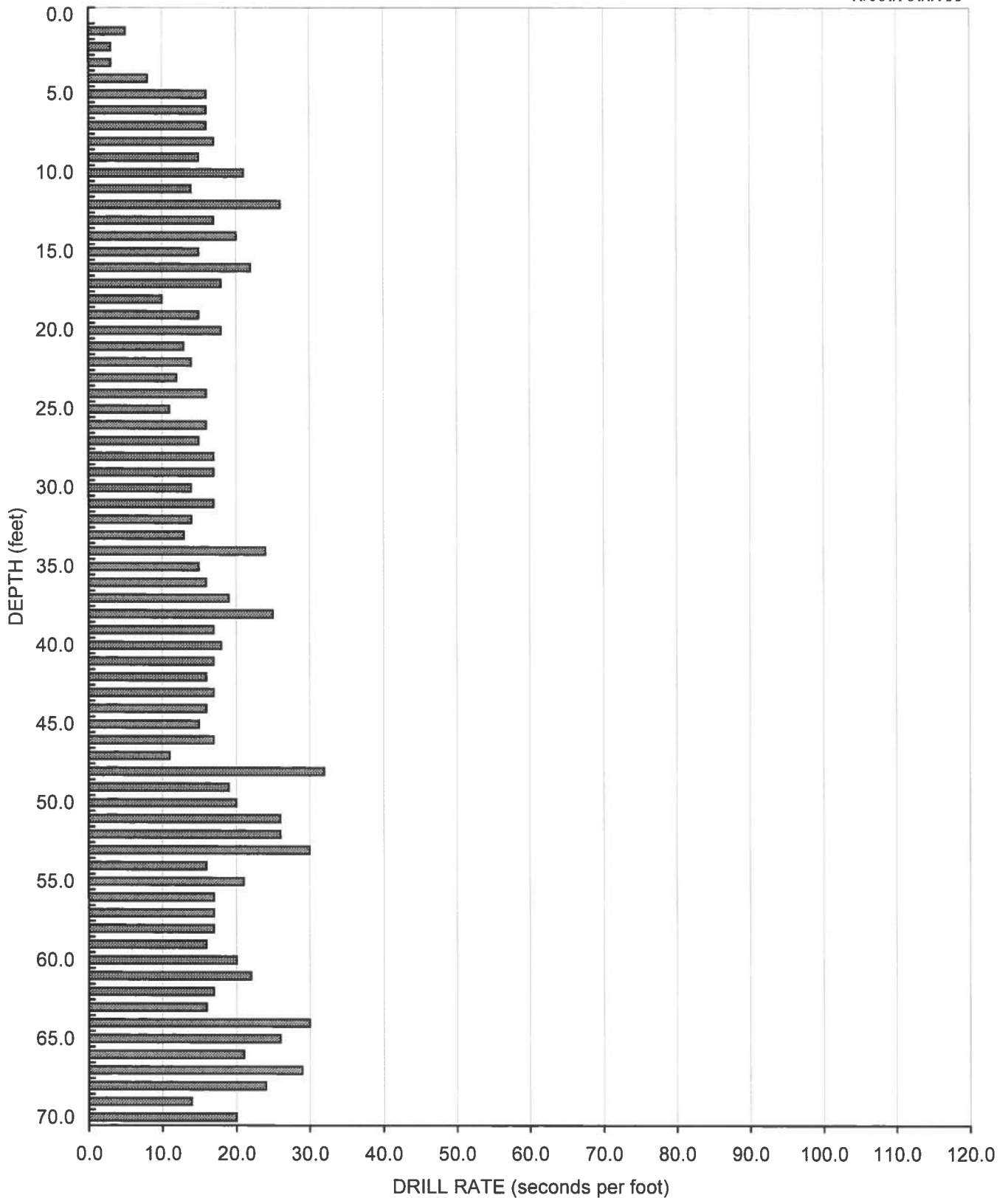

AIR TRACK BORING AT-3
Elevation - 1055 Feet (MSL)



GEOCON
INCORPORATED

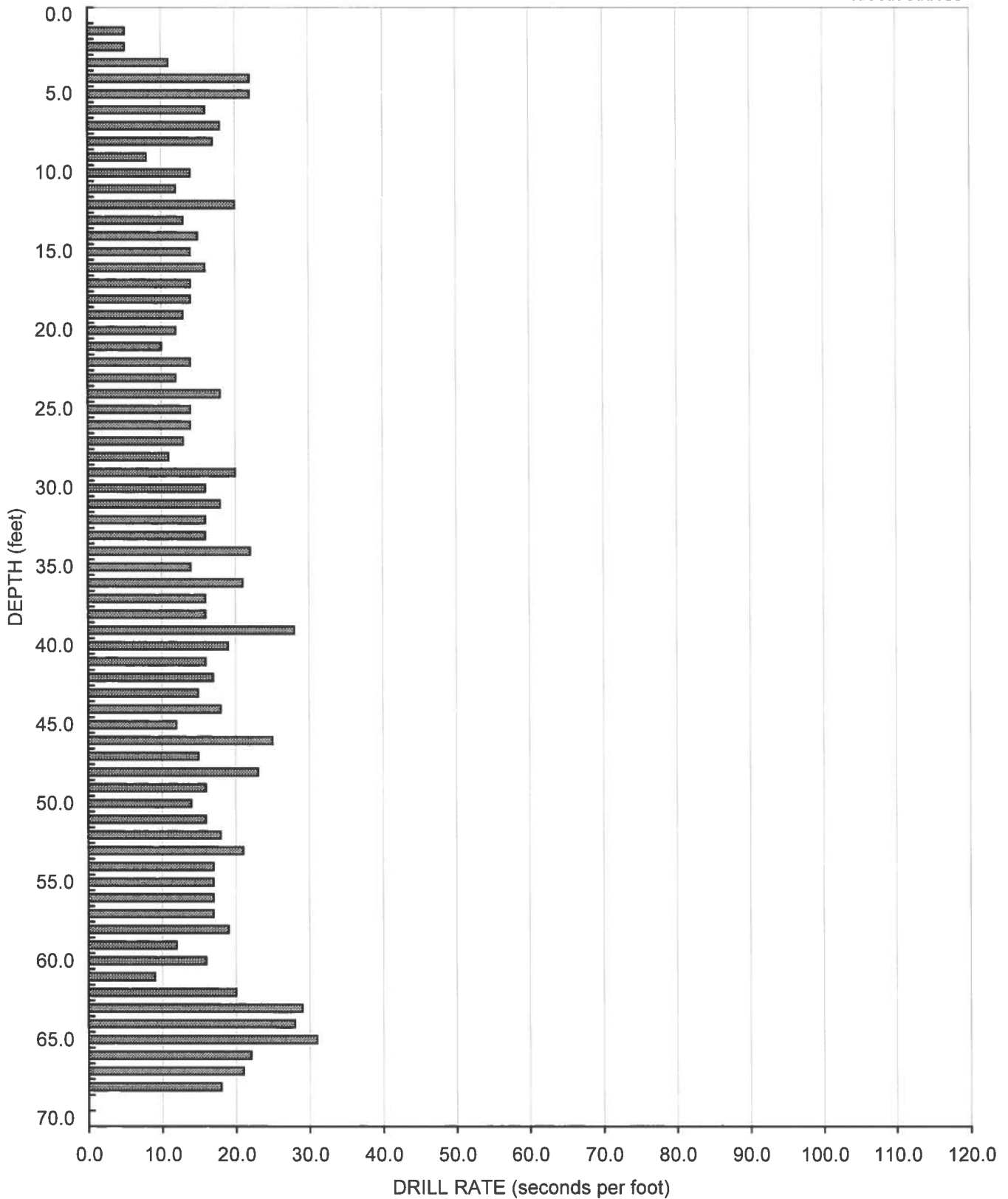

AIR TRACK BORING AT-4
Elevation - 1080 Feet (MSL)



GEOCON
INCORPORATED

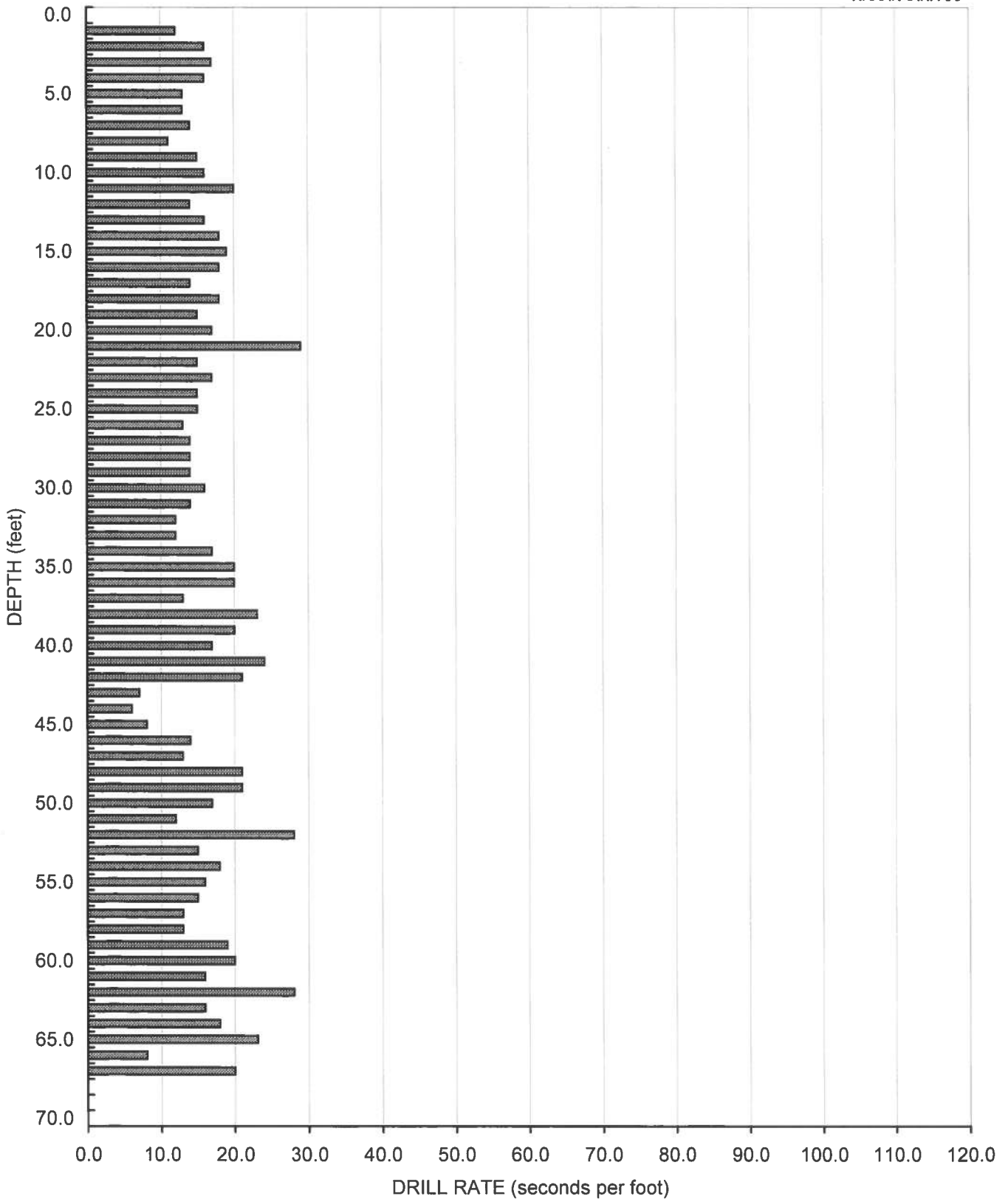

AIR TRACK BORING AT-5
Elevation - 1060 Feet (MSL)



GEOCON
INCORPORATED

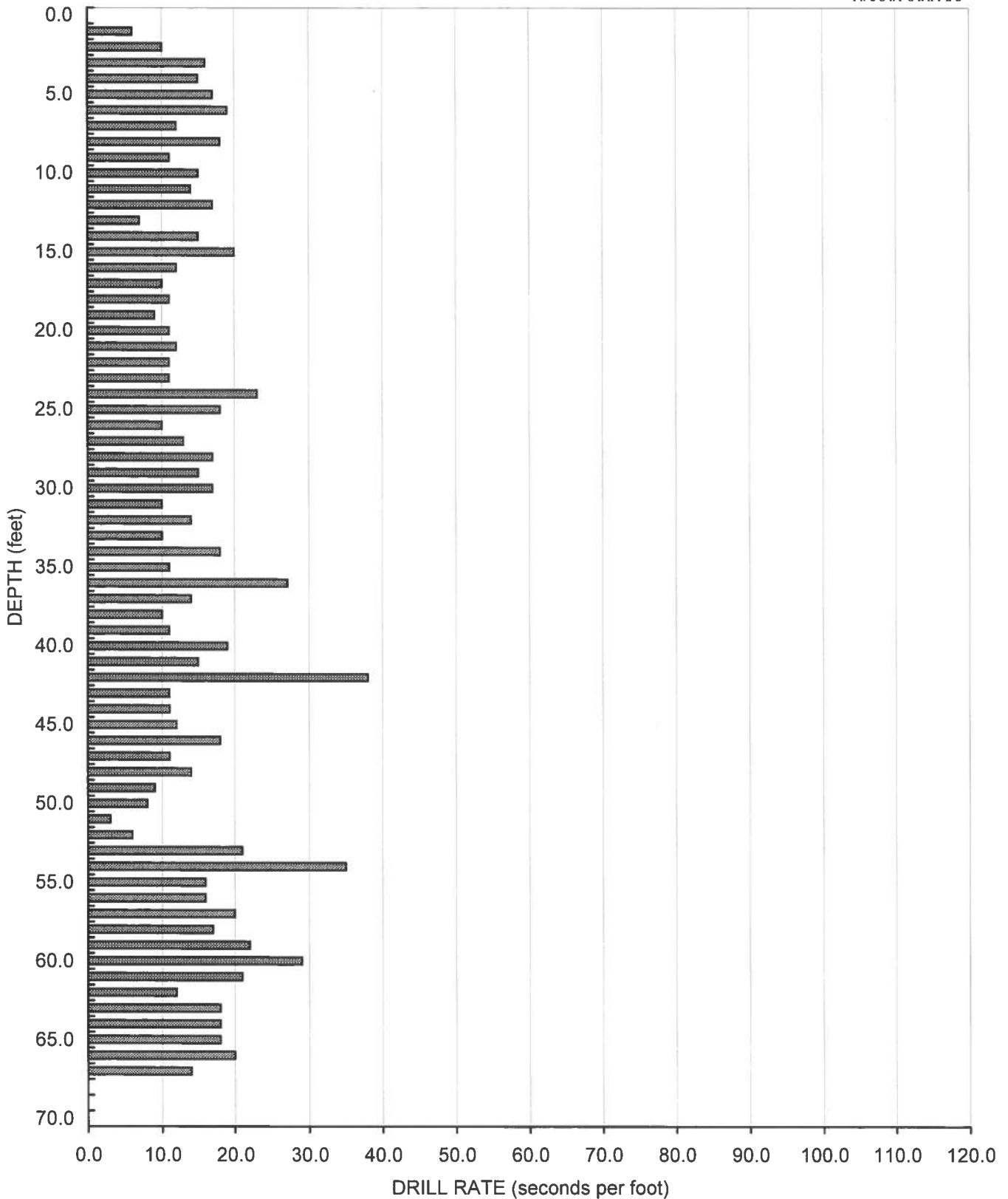

AIR TRACK BORING AT-6
Elevation - 1060 Feet (MSL)



GEOCON
INCORPORATED

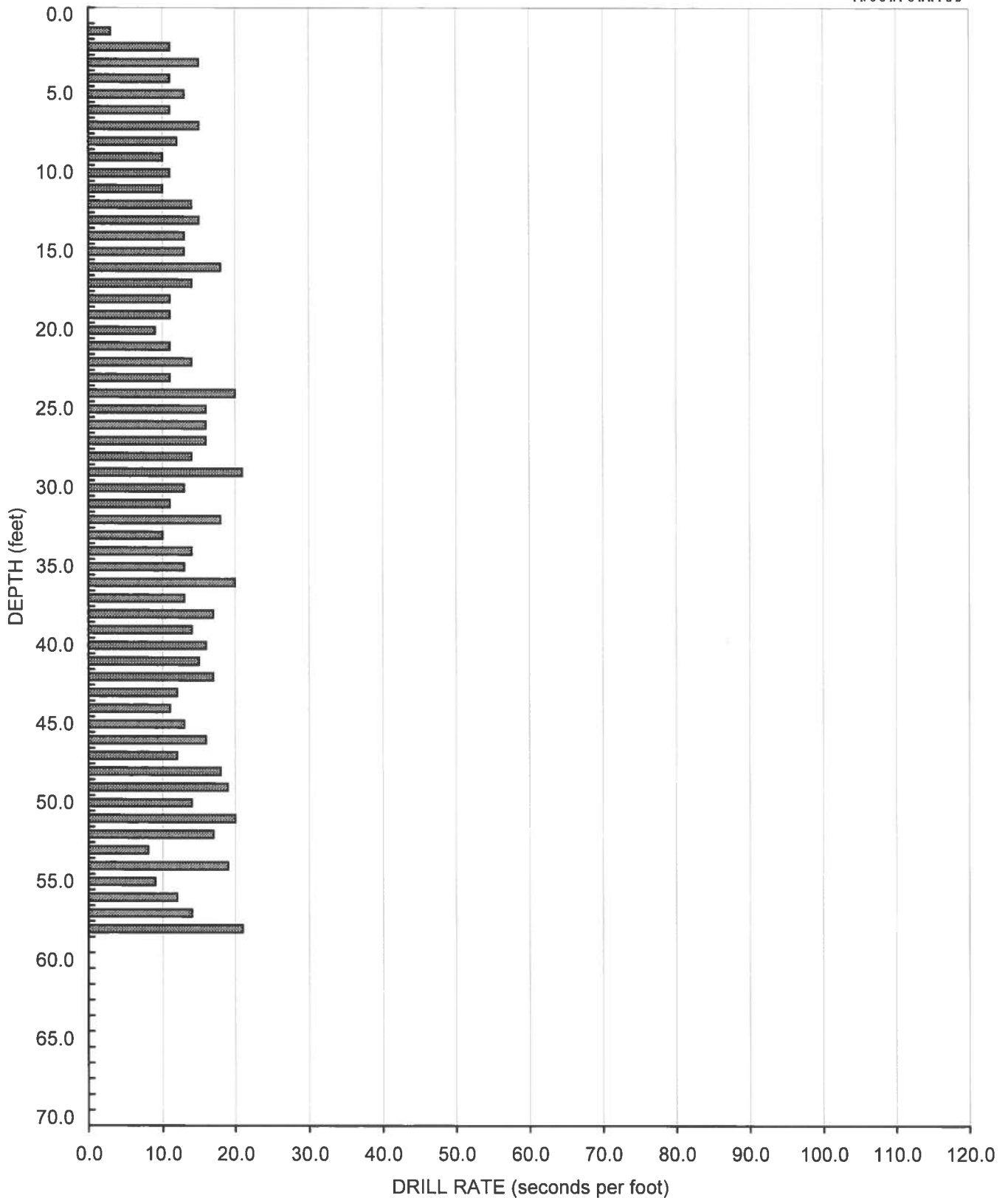

AIR TRACK BORING AT-7
Elevation - 1060 Feet (MSL)



GEOCON
INCORPORATED

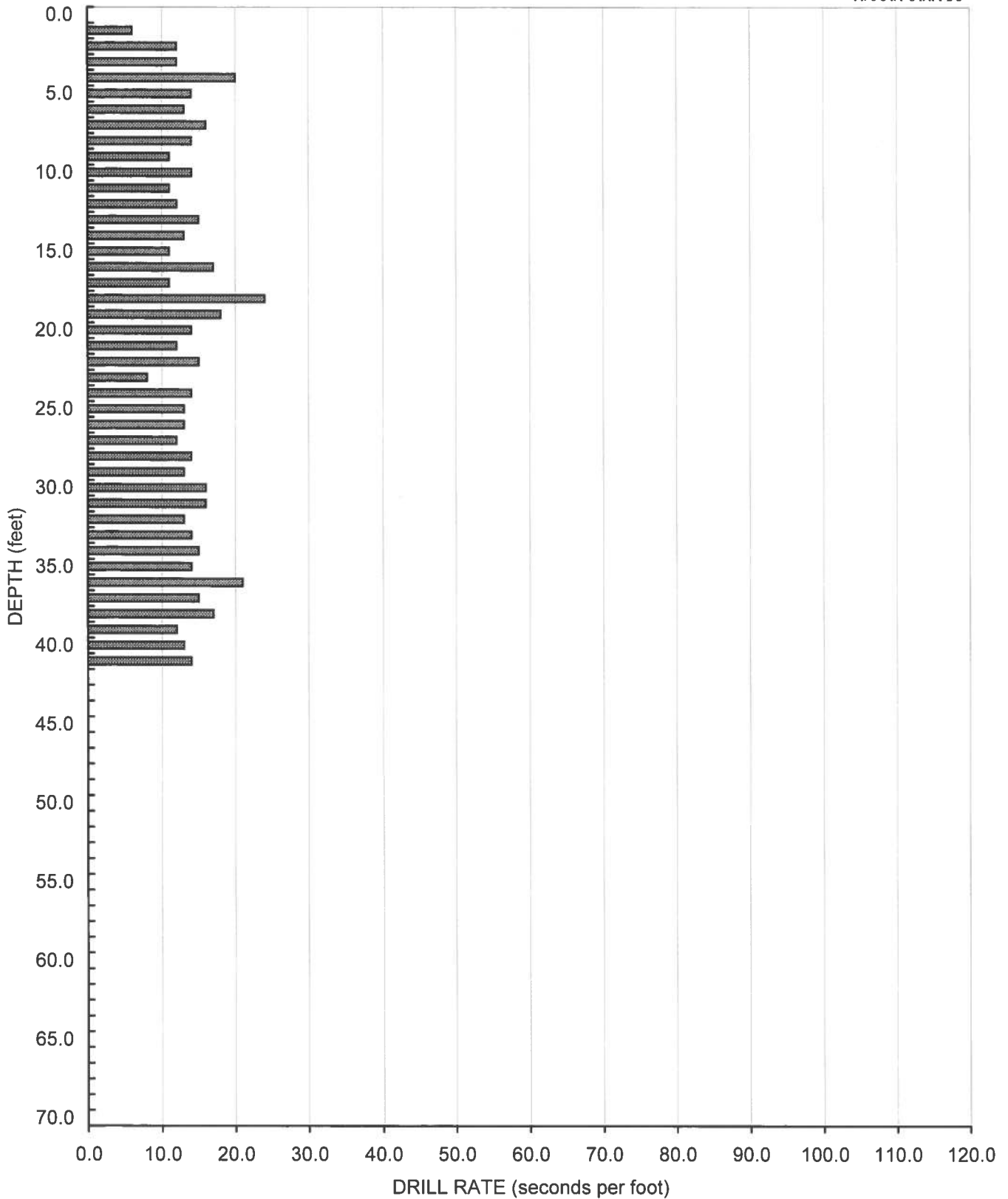

AIR TRACK BORING AT-8
Elevation - 1085 Feet (MSL)



GEOCON
INCORPORATED

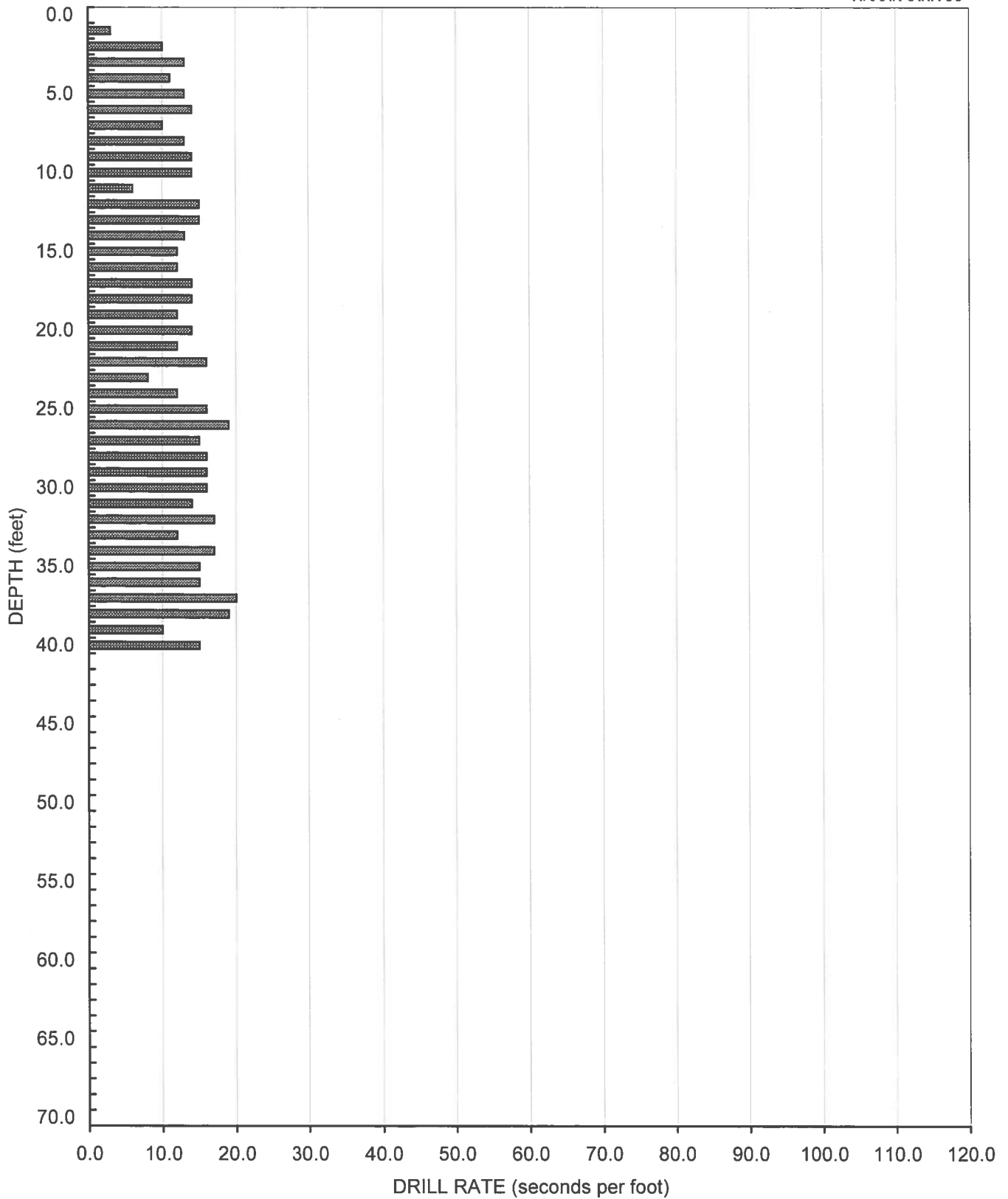

AIR TRACK BORING AT-9
Elevation - 1100 Feet (MSL)



GEOCON
INCORPORATED

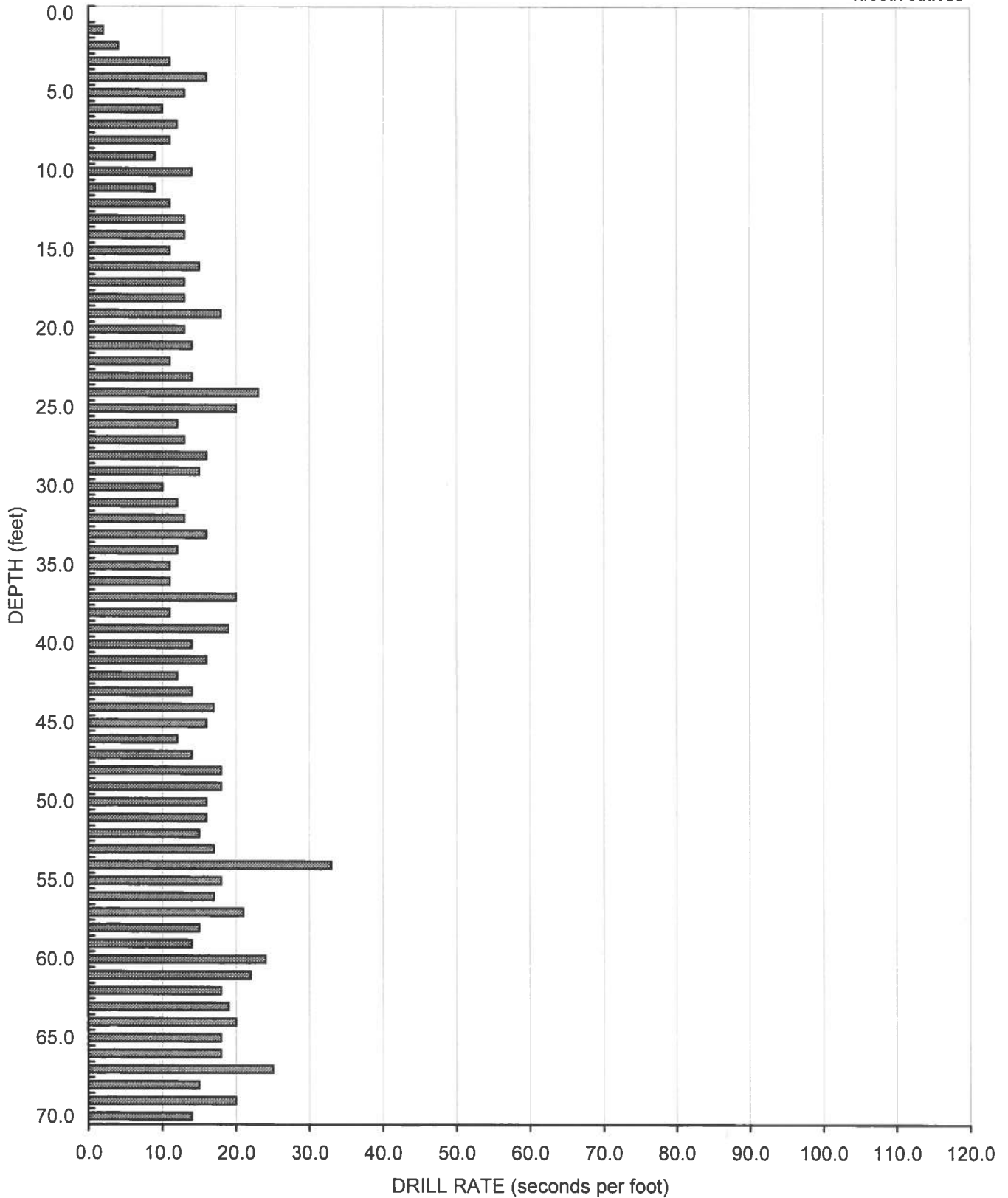

AIR TRACK BORING AT-10
Elevation - 1090 Feet (MSL)



GEOCON
INCORPORATED

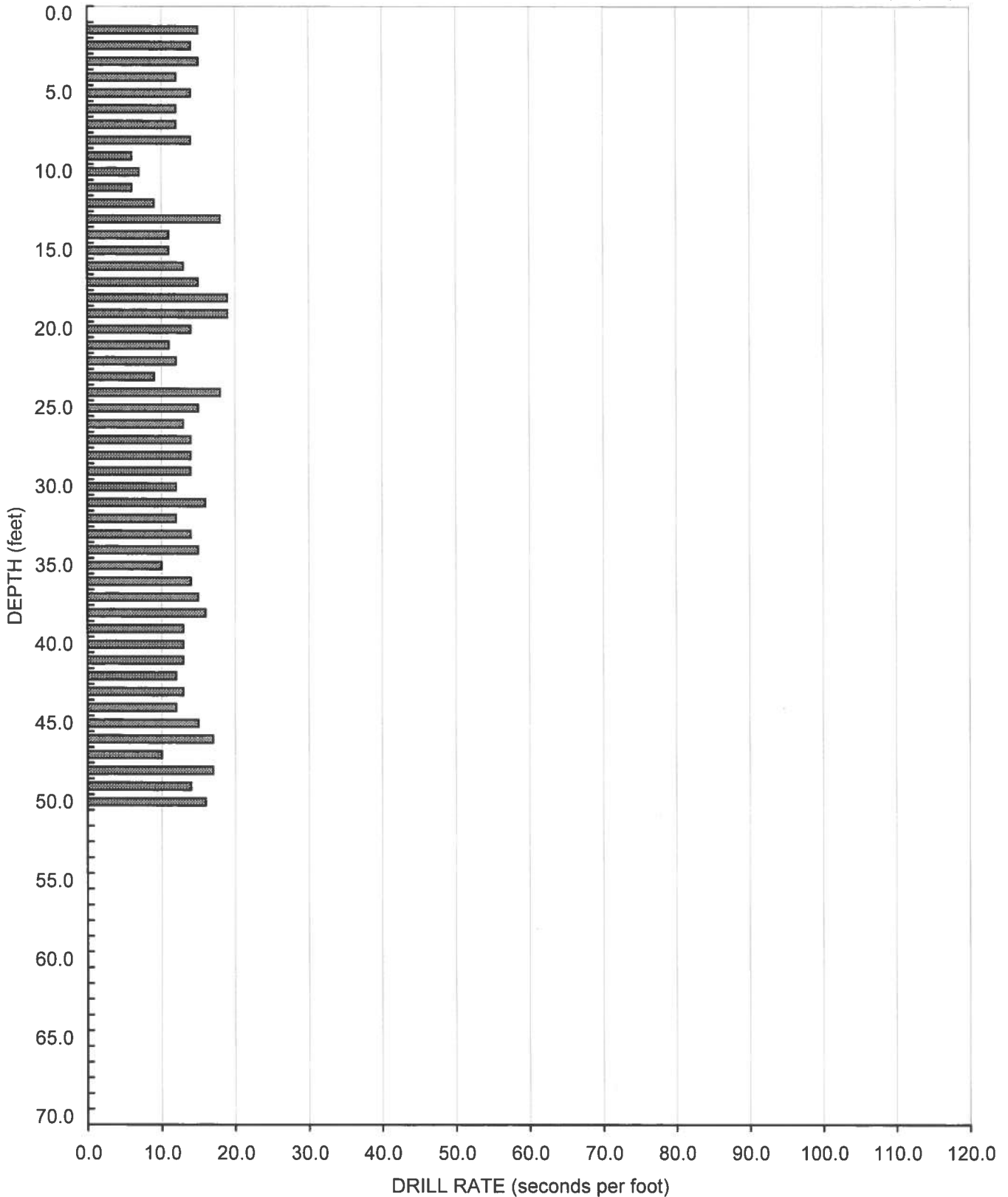

AIR TRACK BORING AT-11
Elevation - 1100 Feet (MSL)



GEOCON
INCORPORATED

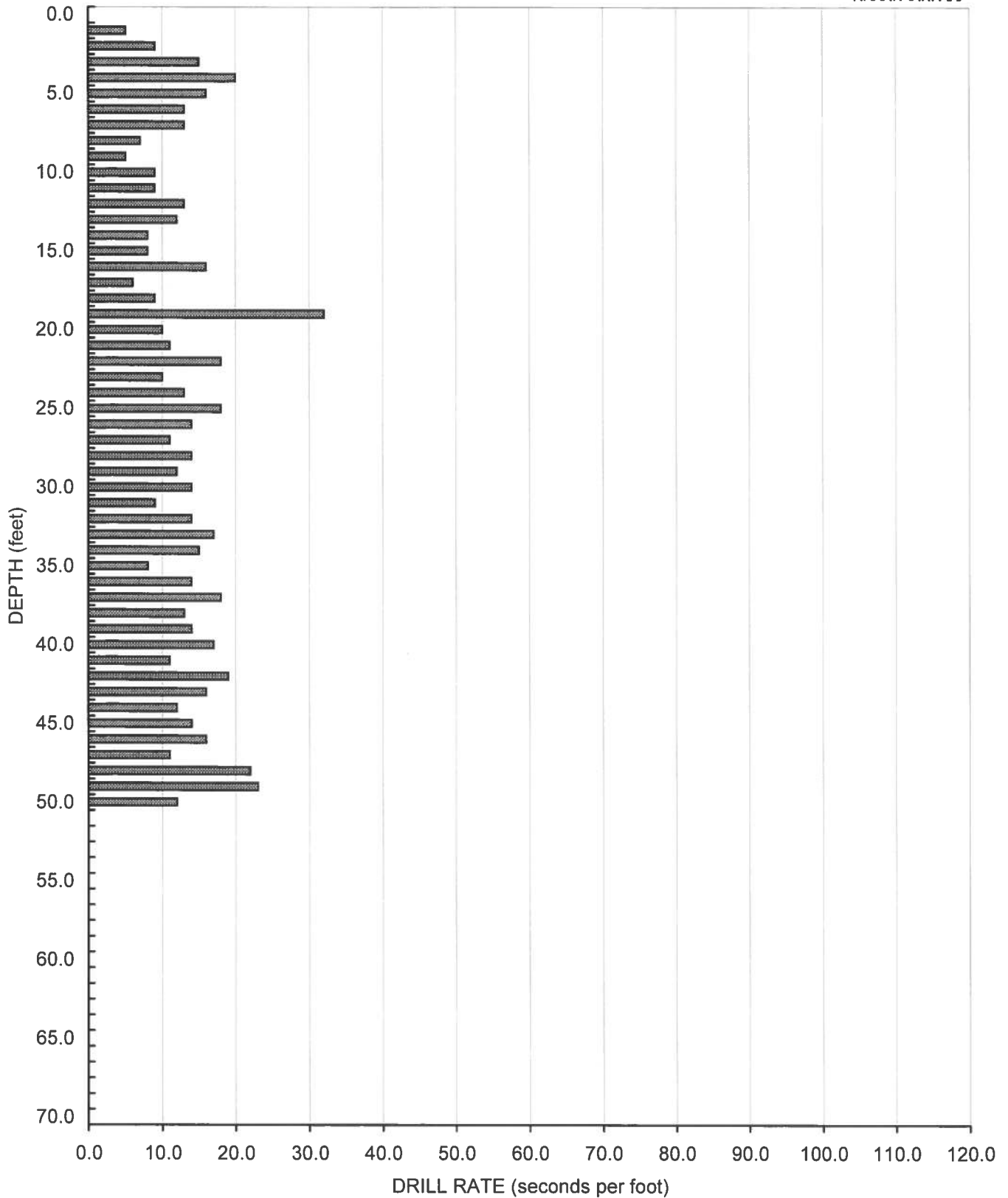

AIR TRACK BORING AT-12
Elevation - 1160 Feet (MSL)



GEOCON
INCORPORATED

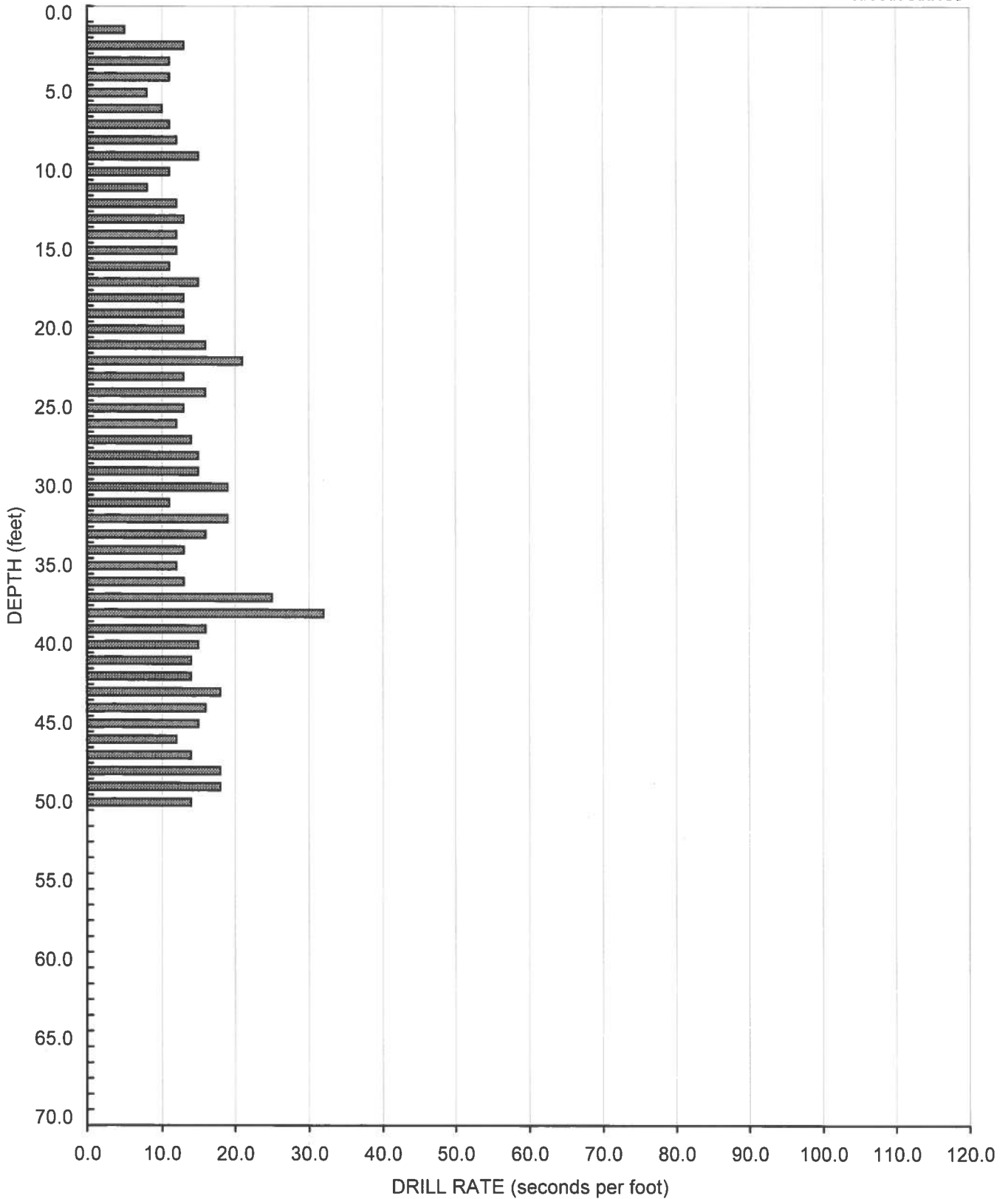

AIR TRACK BORING AT-13
Elevation - 1160 Feet (MSL)



GEOCON
INCORPORATED

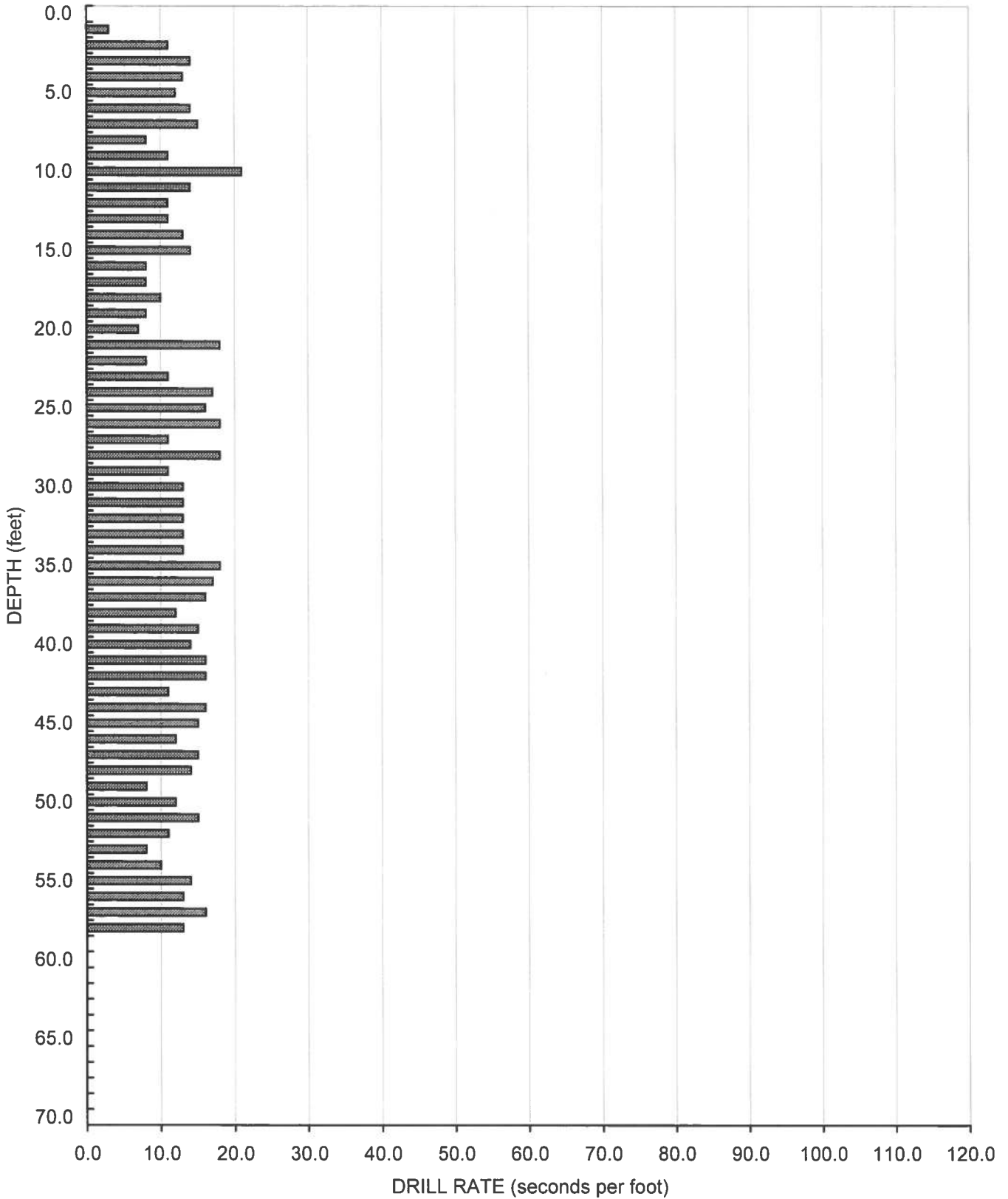

AIR TRACK BORING AT-14
Elevation - 1140 Feet (MSL)



GEOCON
INCORPORATED

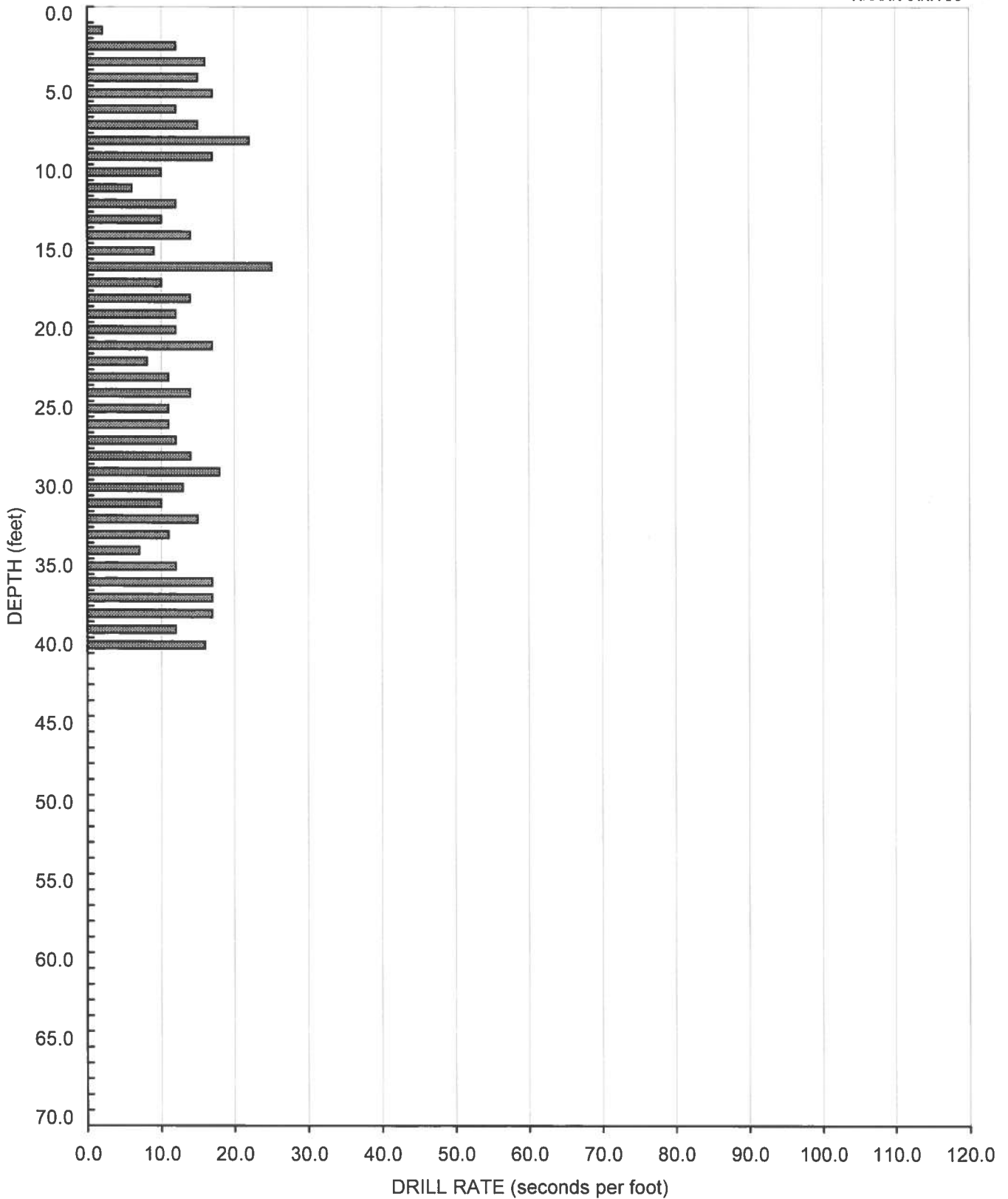

AIR TRACK BORING AT-15
Elevation - 1170 Feet (MSL)



GEOCON
INCORPORATED

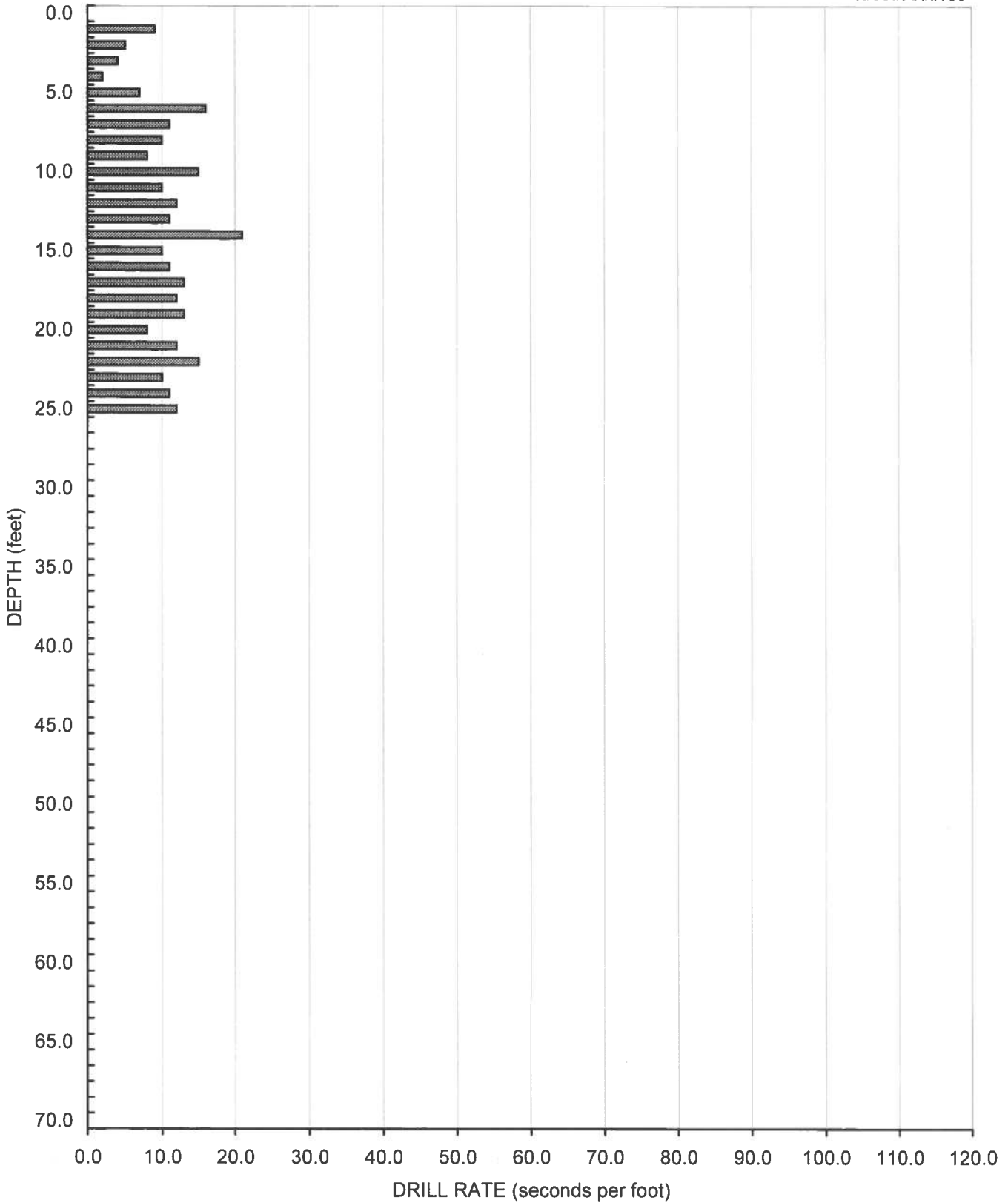

AIR TRACK BORING AT-16
Elevation - 1180 Feet (MSL)



GEOCON
INCORPORATED

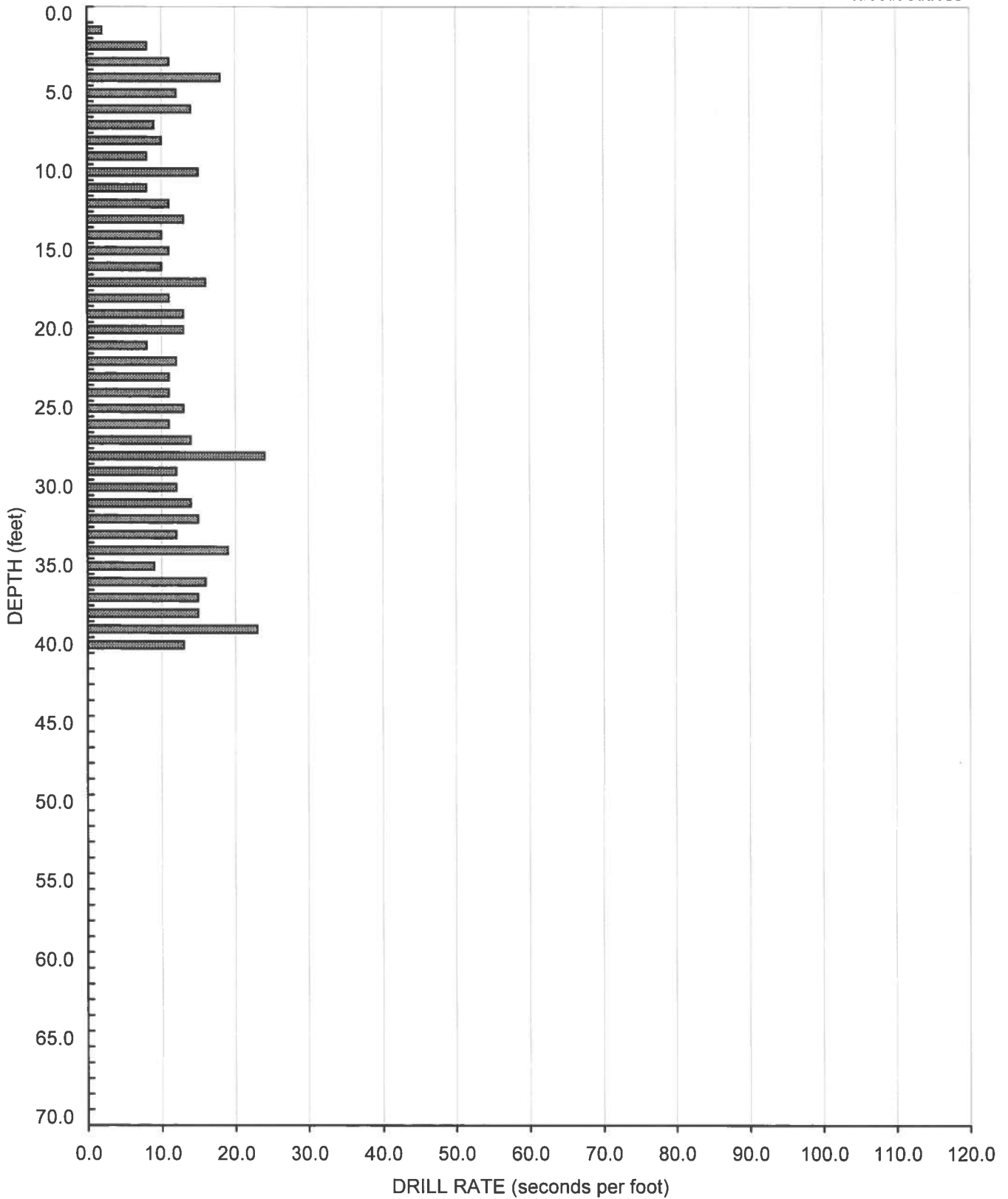

AIR TRACK BORING AT-17
Elevation - 1190 Feet (MSL)



GEOCON
INCORPORATED

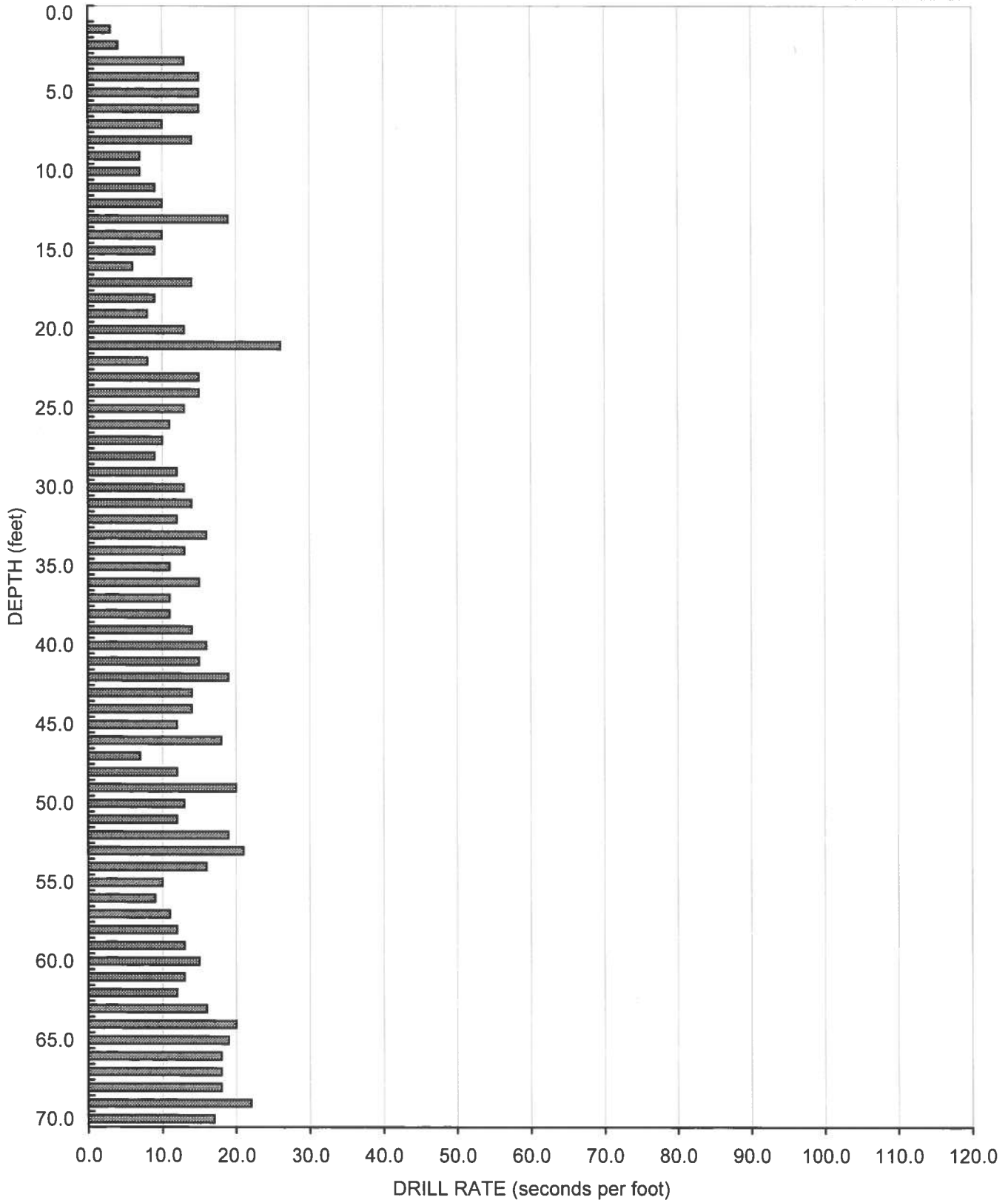

AIR TRACK BORING AT-18
Elevation - 1160 Feet (MSL)



GEOCON
INCORPORATED

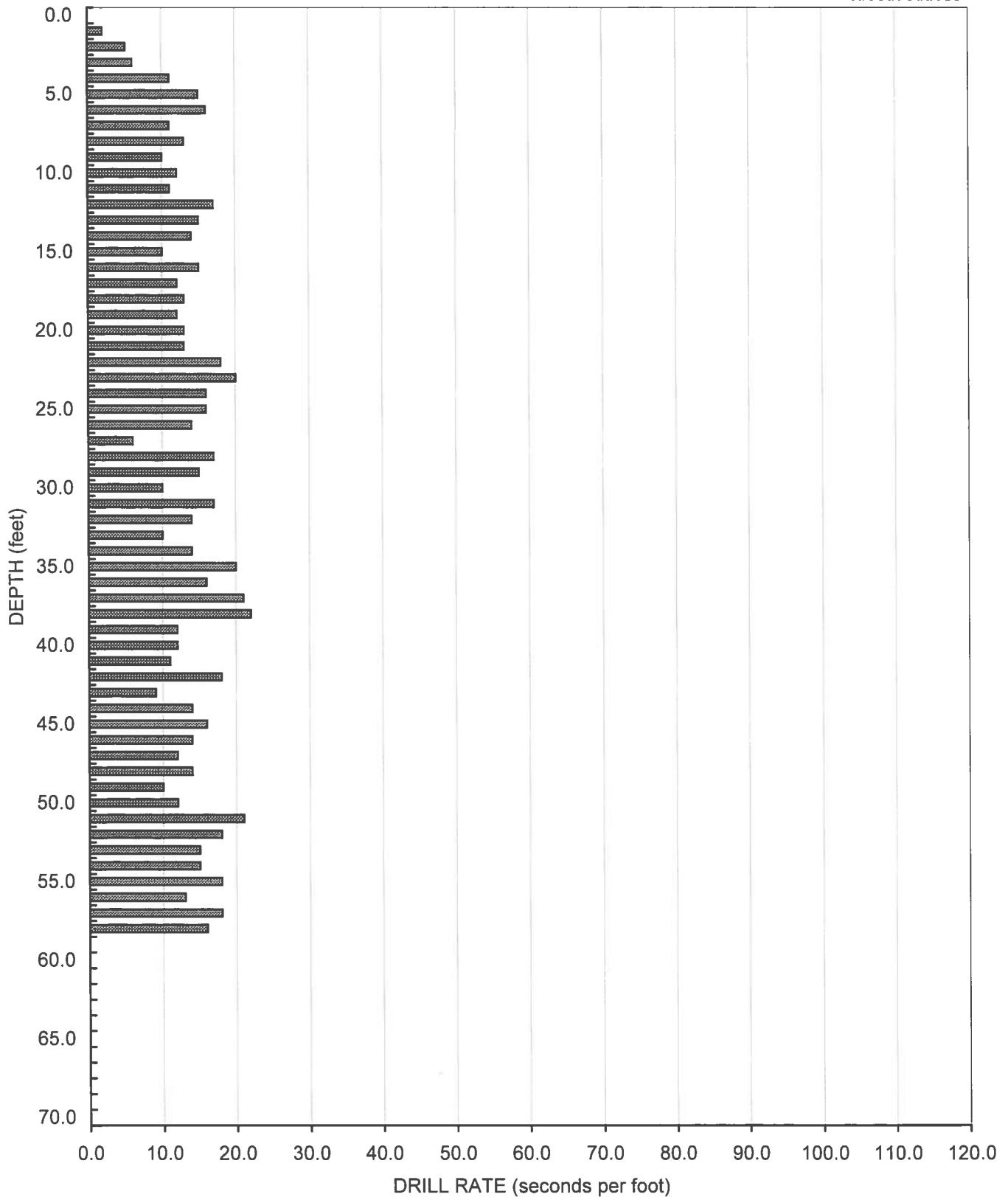

AIR TRACK BORING AT-19
Elevation - 1180 Feet (MSL)



GEOCON
INCORPORATED

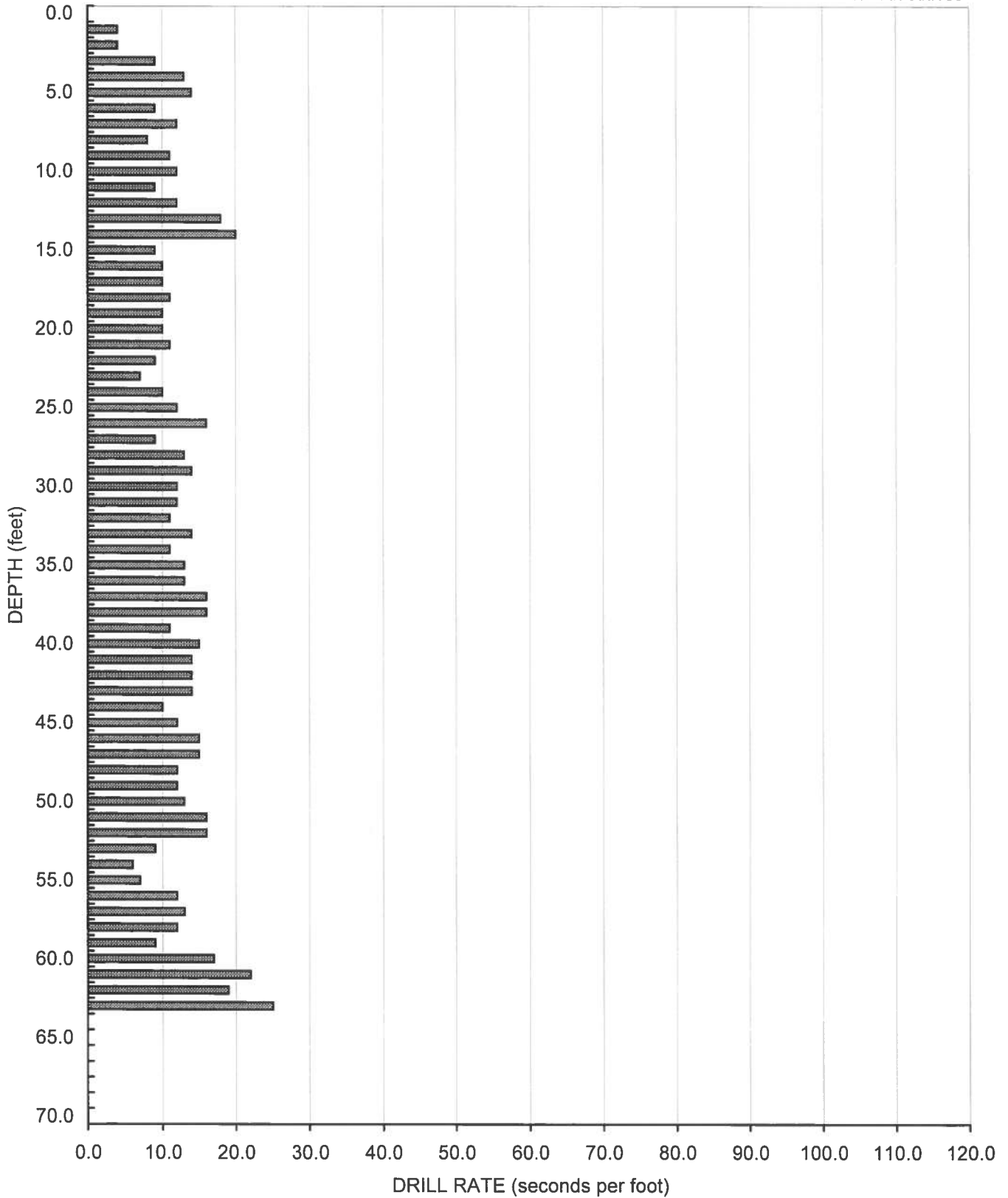

AIR TRACK BORING AT-20

Elevation - 1190 Feet (MSL)



GEOCON
INCORPORATED

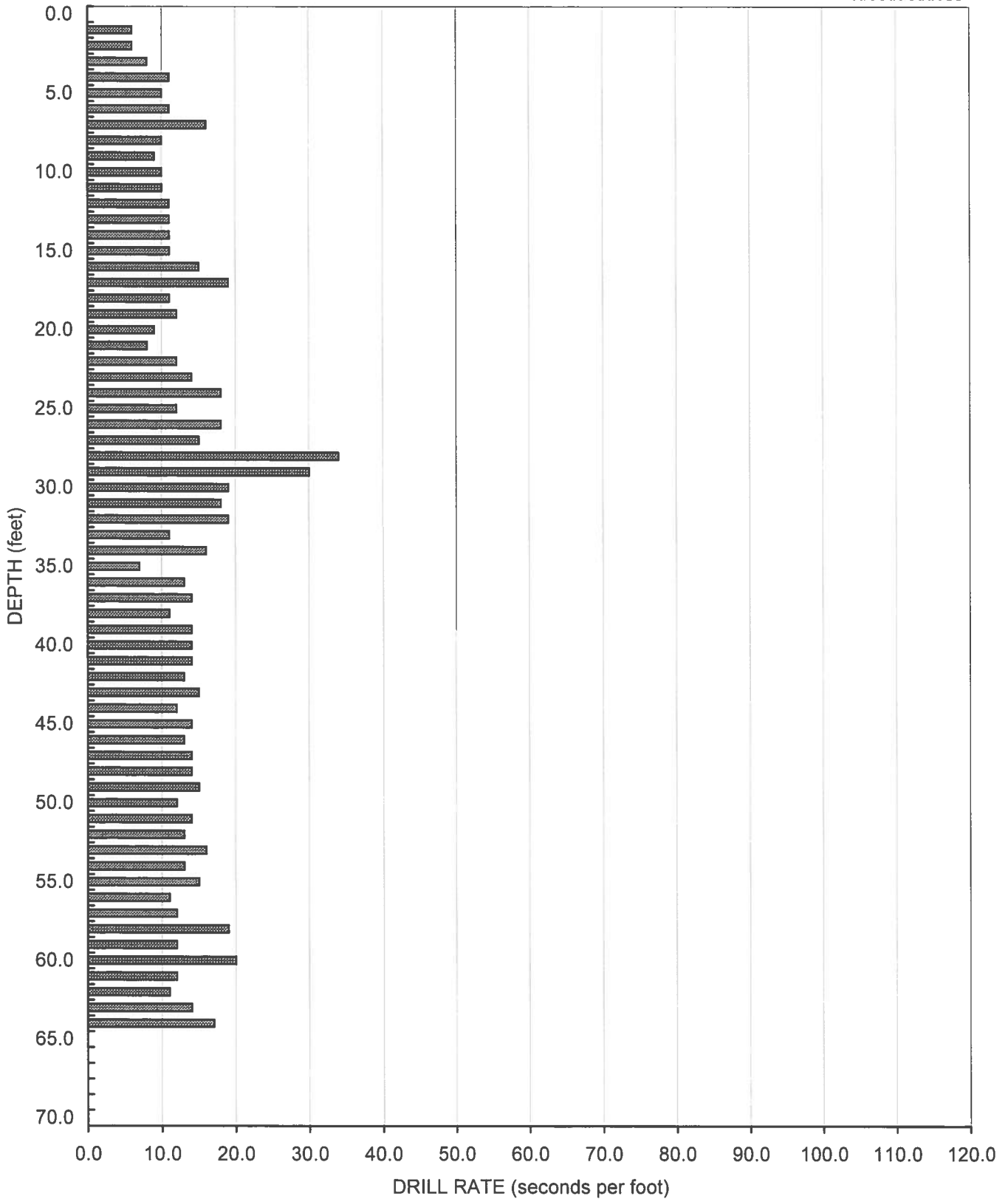

AIR TRACK BORING AT-21
Elevation - 1145 Feet (MSL)



GEOCON
INCORPORATED

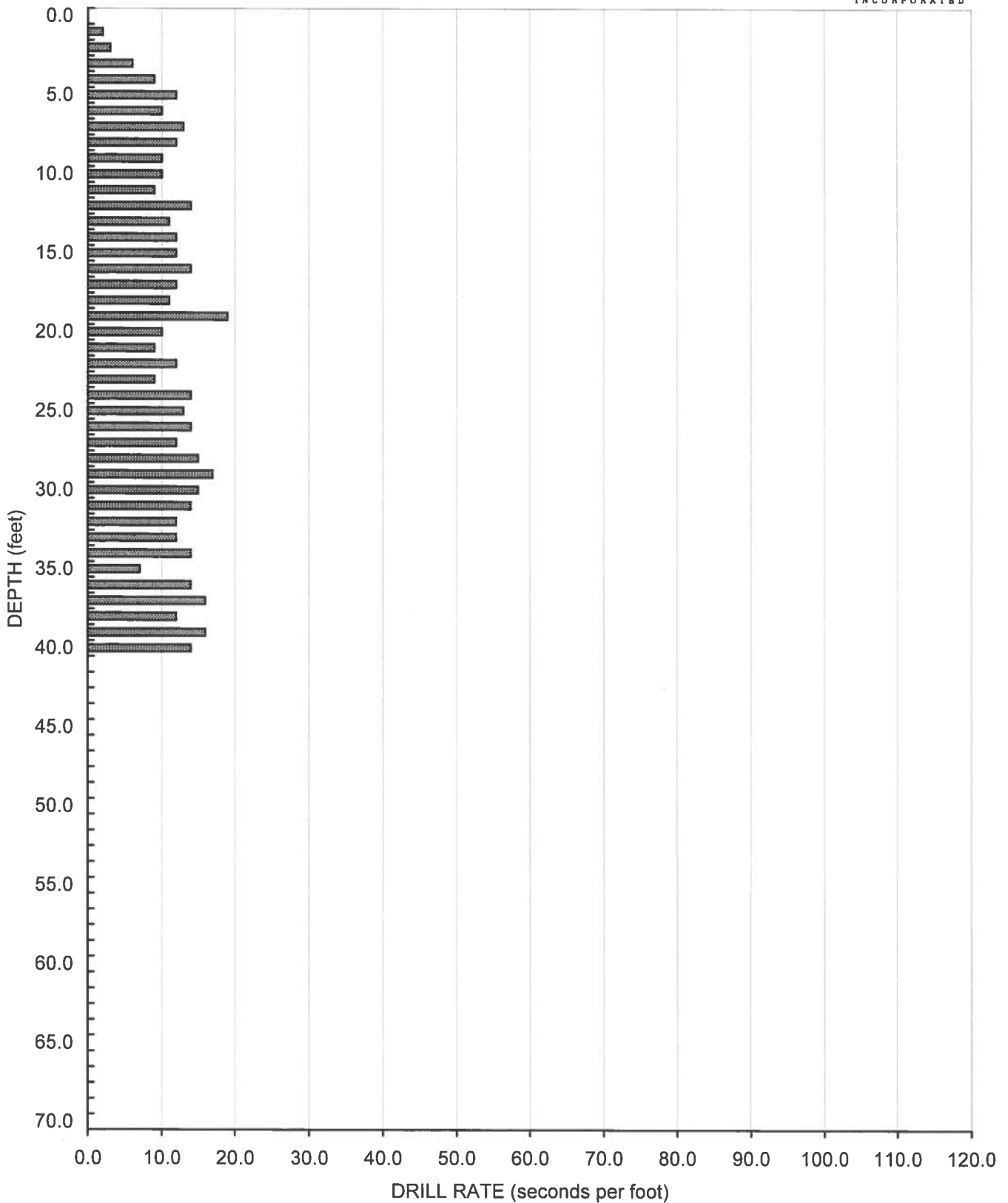

AIR TRACK BORING AT-22
Elevation - 1160 Feet (MSL)



GEOCON
INCORPORATED

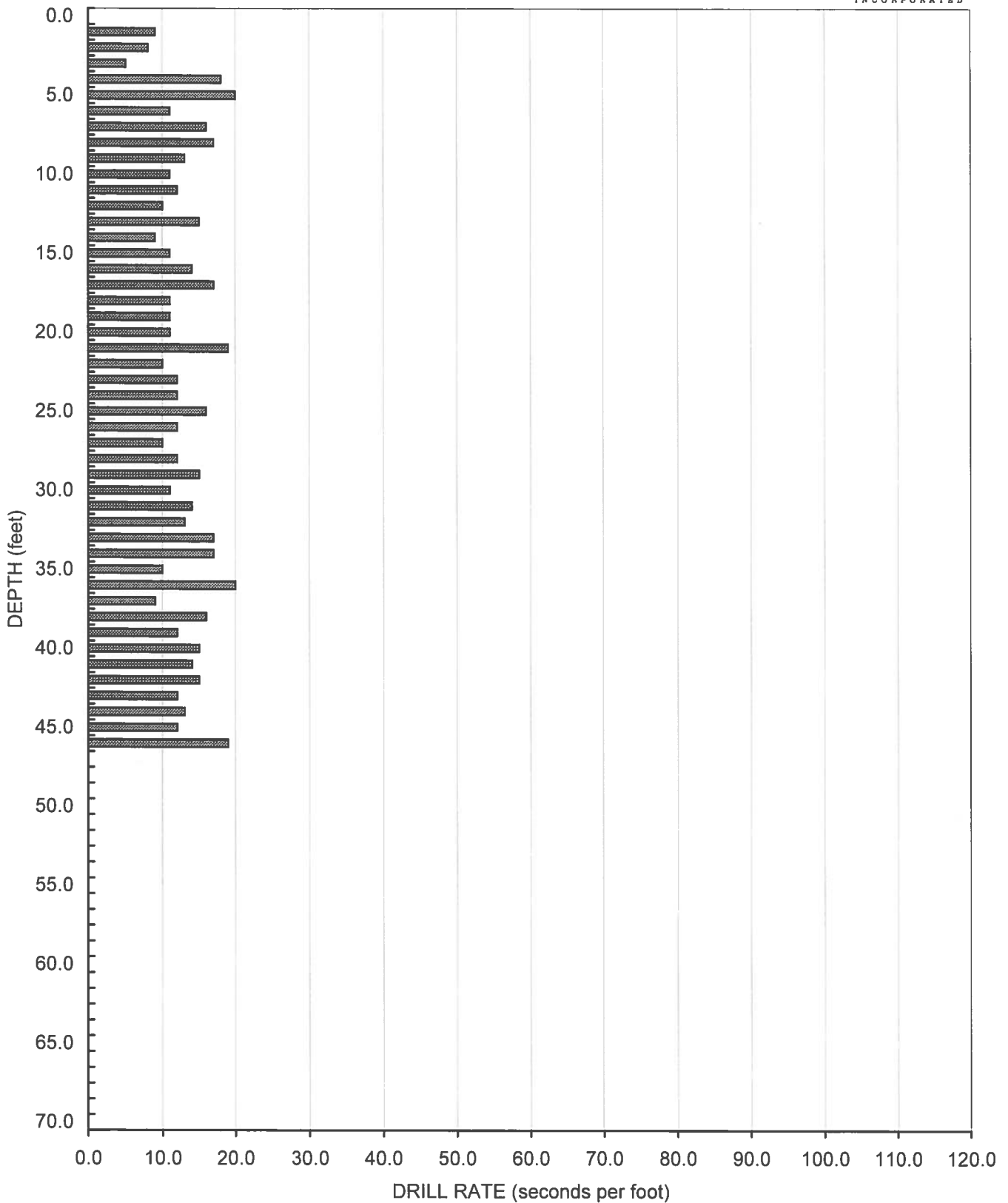

AIR TRACK BORING AT-23
Elevation - 1125 Feet (MSL)



GEOCON
INCORPORATED

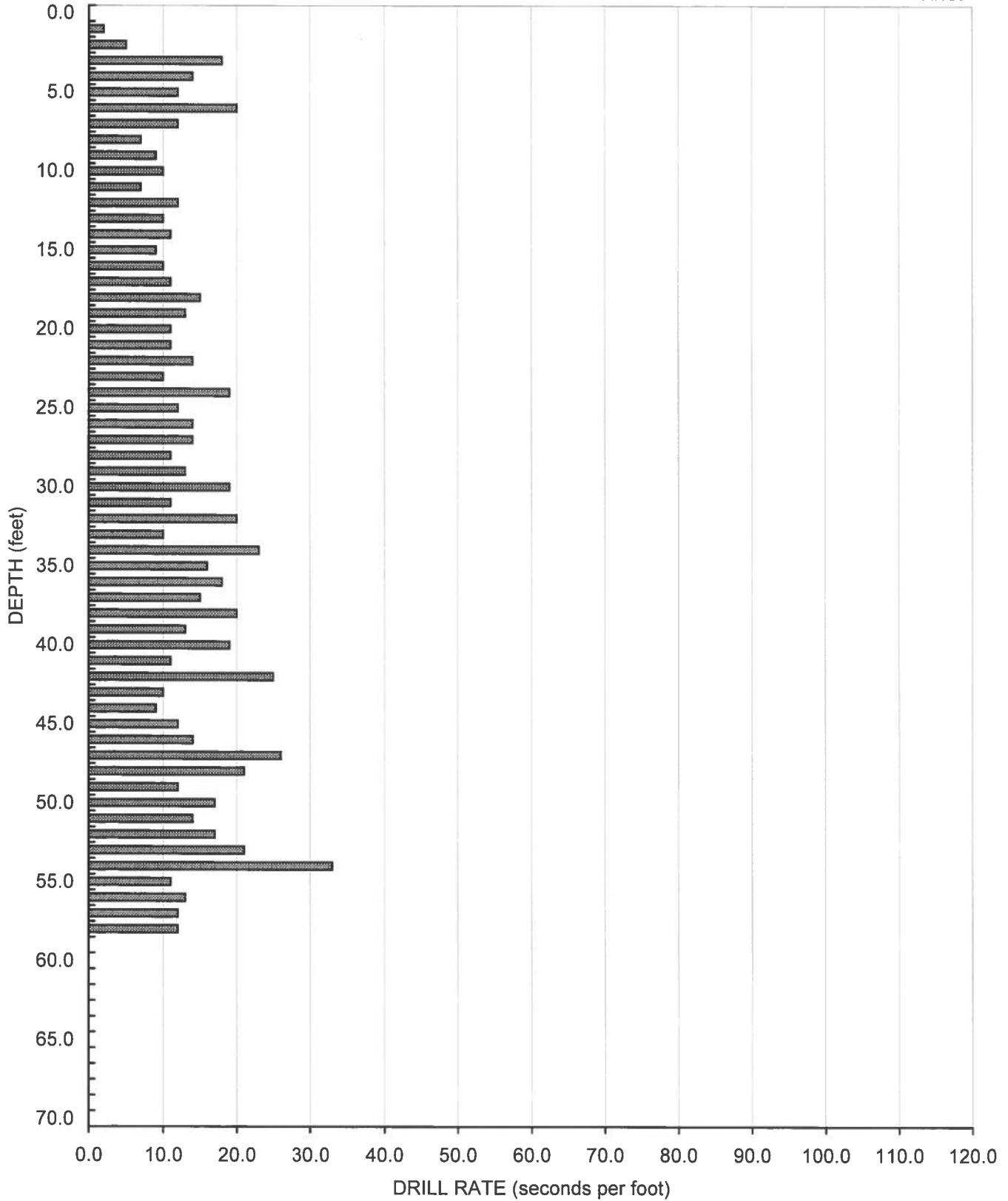

AIR TRACK BORING AT-24
Elevation - 1135 Feet (MSL)



GEOCON
INCORPORATED

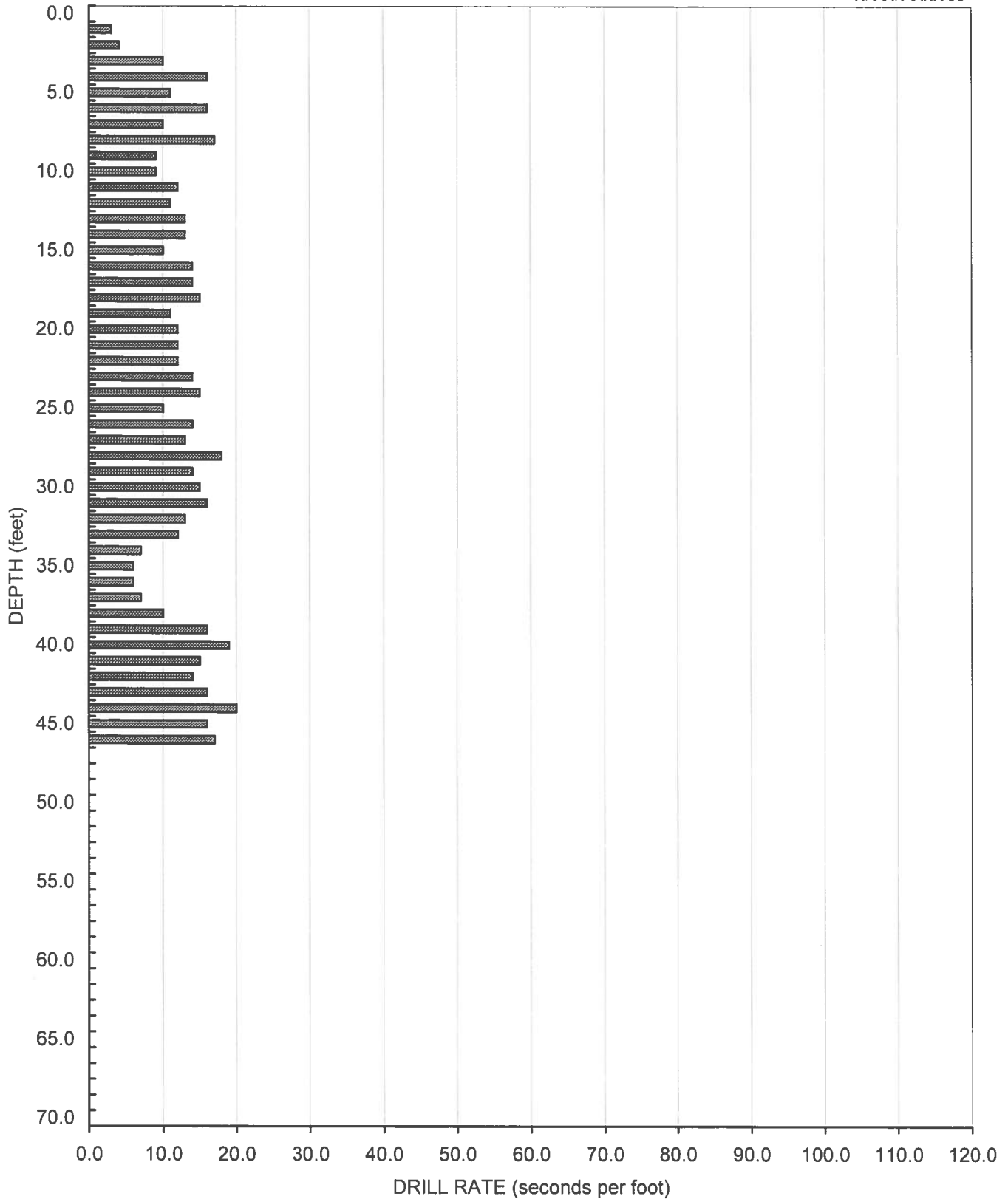

AIR TRACK BORING AT-25
Elevation - 995 Feet (MSL)



GEOCON
INCORPORATED

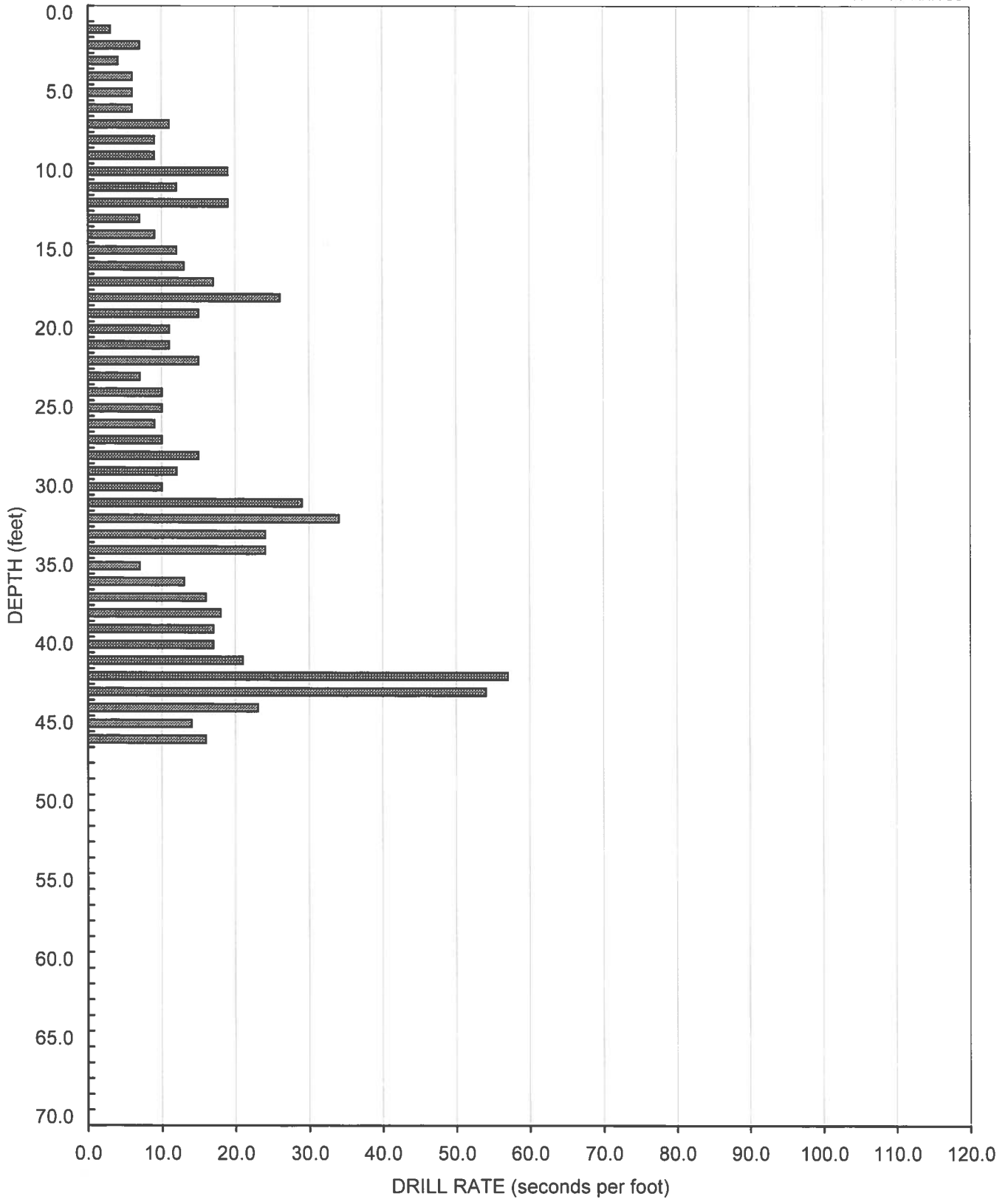

AIR TRACK BORING AT-26
Elevation - 1035 Feet (MSL)



GEOCON
INCORPORATED

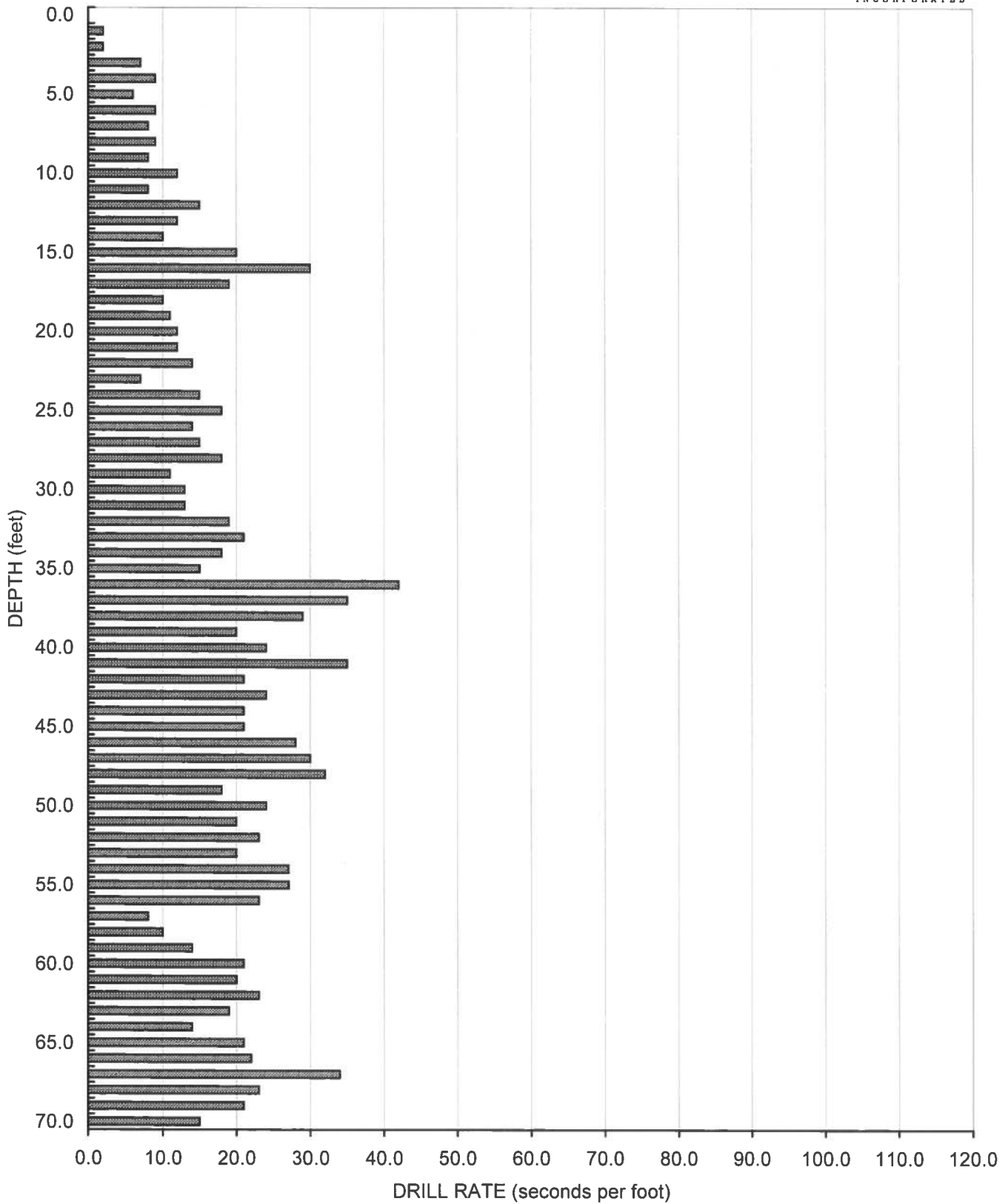

AIR TRACK BORING AT-27
Elevation - 1065 Feet (MSL)



GEOCON
INCORPORATED

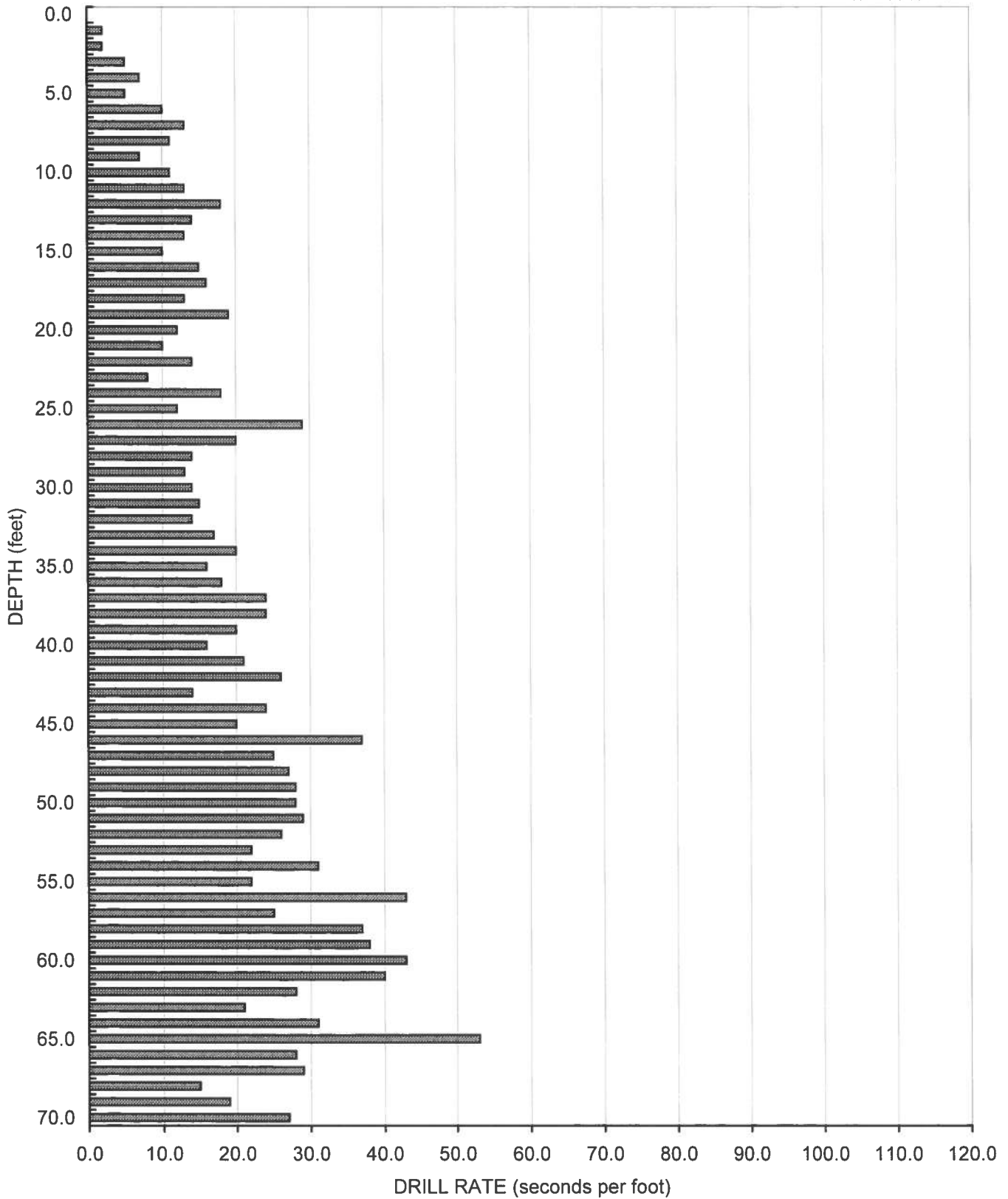

AIR TRACK BORING AT-28
Elevation - 1105 Feet (MSL)



GEOCON
INCORPORATED

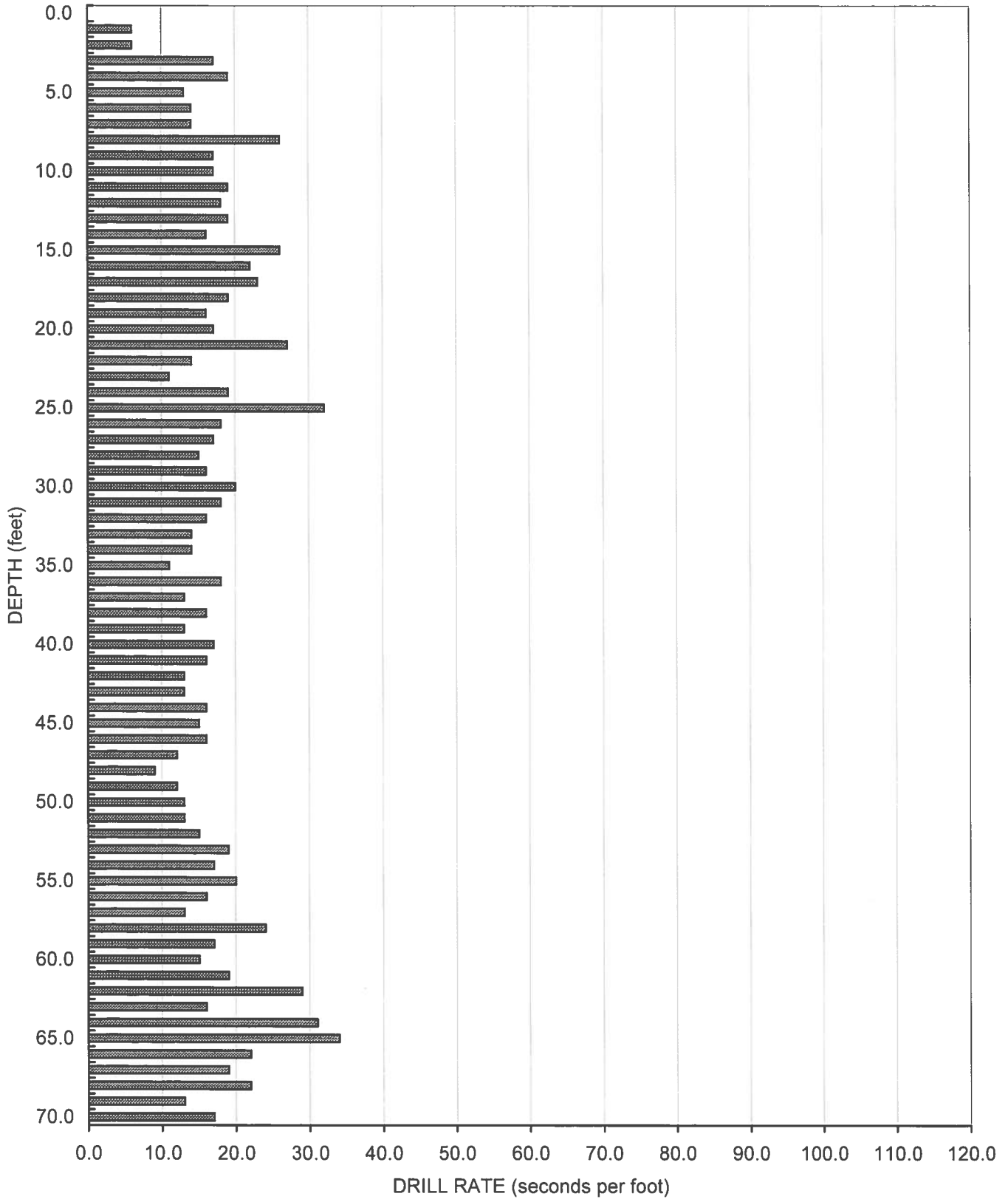

FANITA RANCH

AIR TRACK BORING AT-29
Elevation - 1070 Feet (MSL)



GEOCON
INCORPORATED

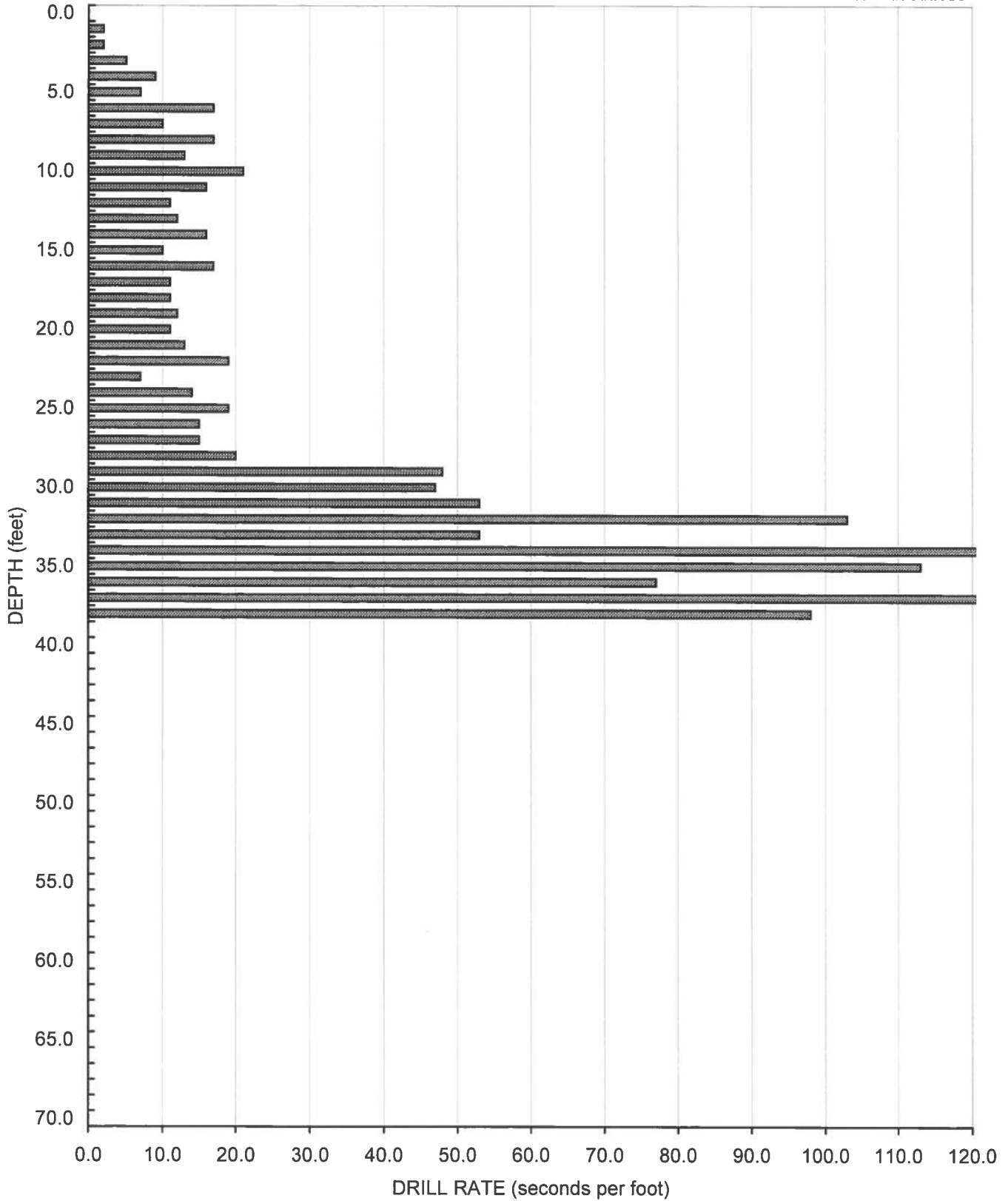

AIR TRACK BORING AT-30
Elevation - 1100 Feet (MSL)



GEOCON
INCORPORATED

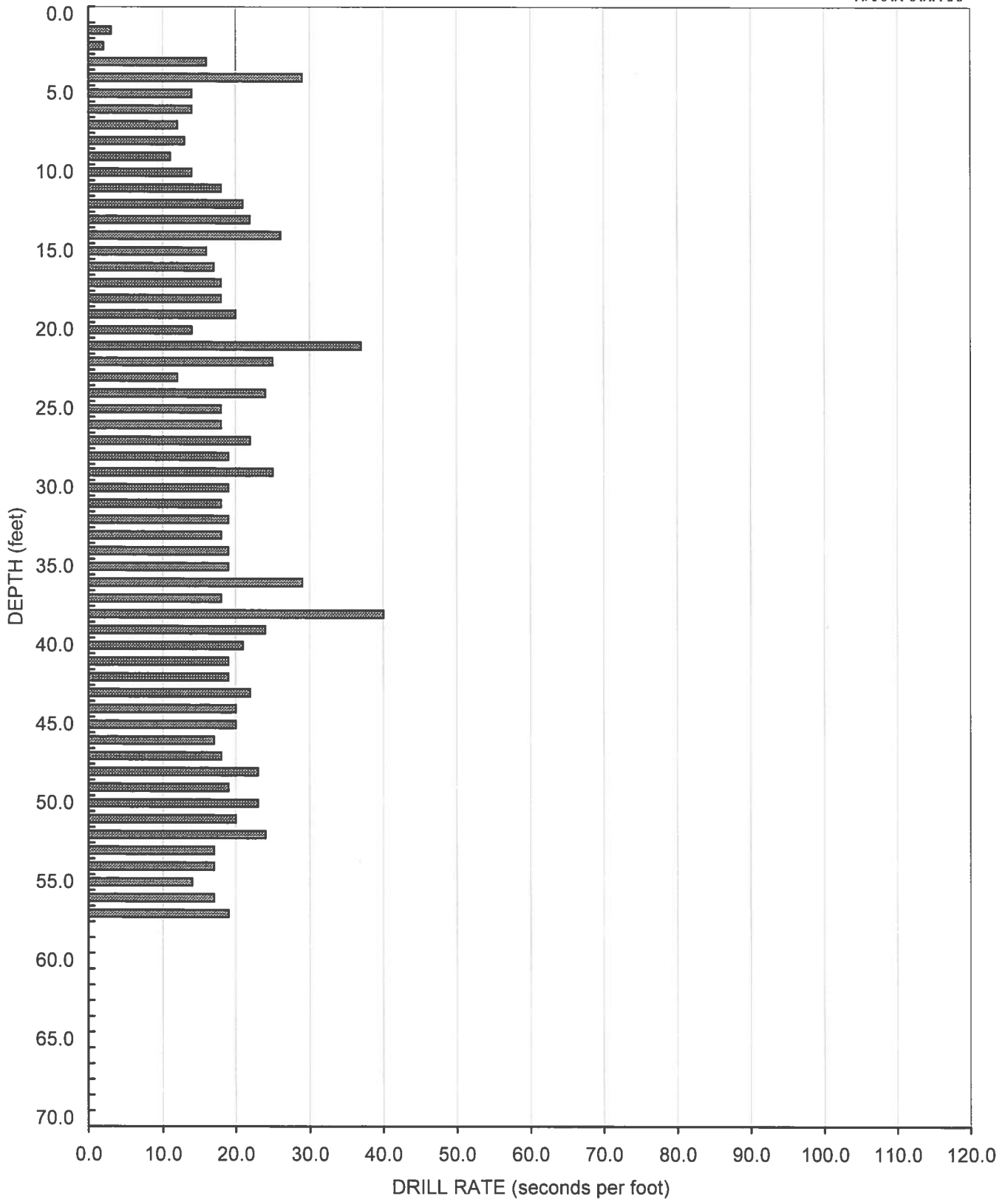

AIR TRACK BORING AT-31
Elevation - 1080 Feet (MSL)



GEOCON
INCORPORATED

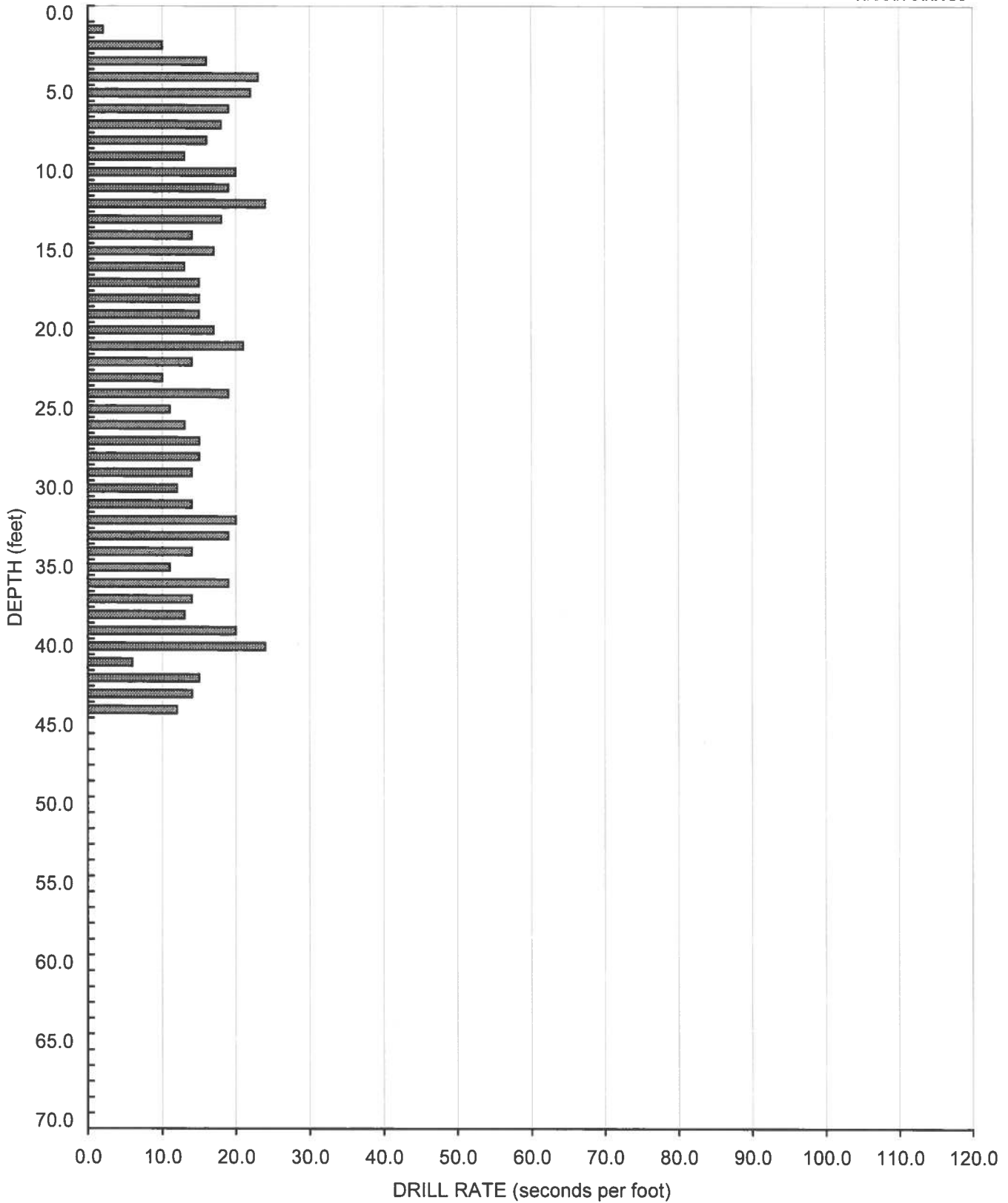

AIR TRACK BORING AT-32
Elevation - 1060 Feet (MSL)



GEOCON
INCORPORATED

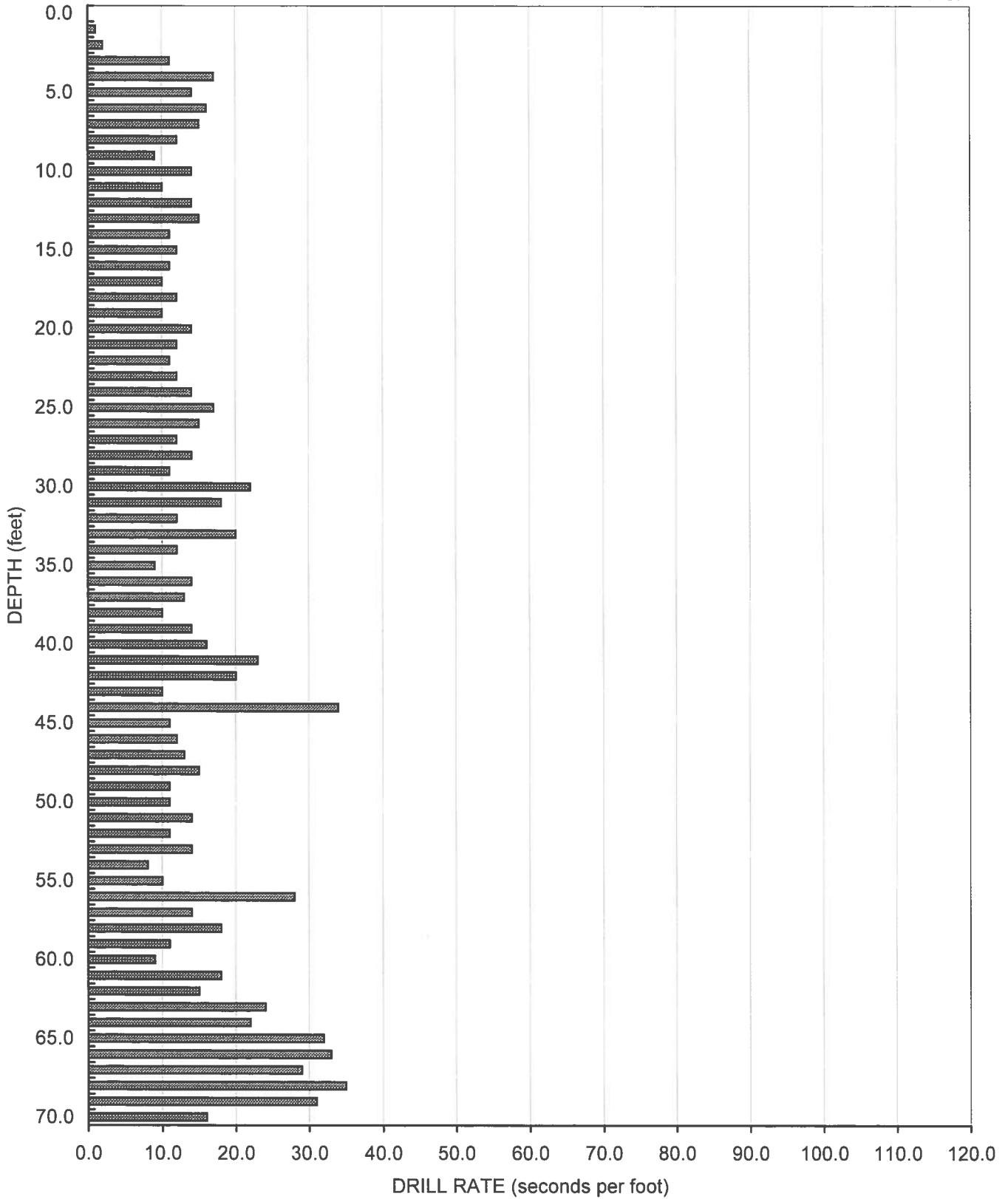

AIR TRACK BORING AT-33
Elevation - 1145 Feet (MSL)



GEOCON
INCORPORATED

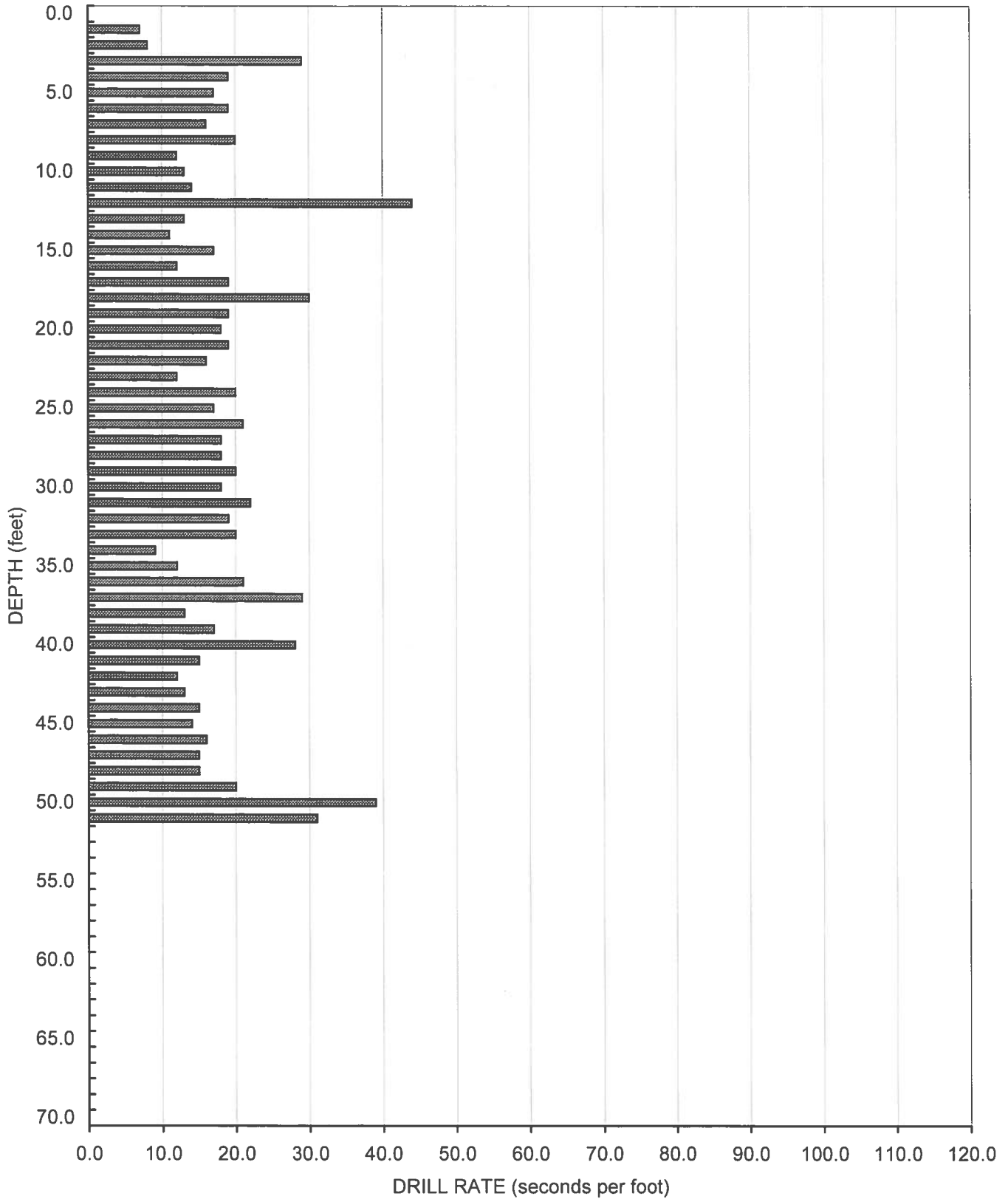

AIR TRACK BORING AT-34
Elevation - 1105 Feet (MSL)



GEOCON
INCORPORATED

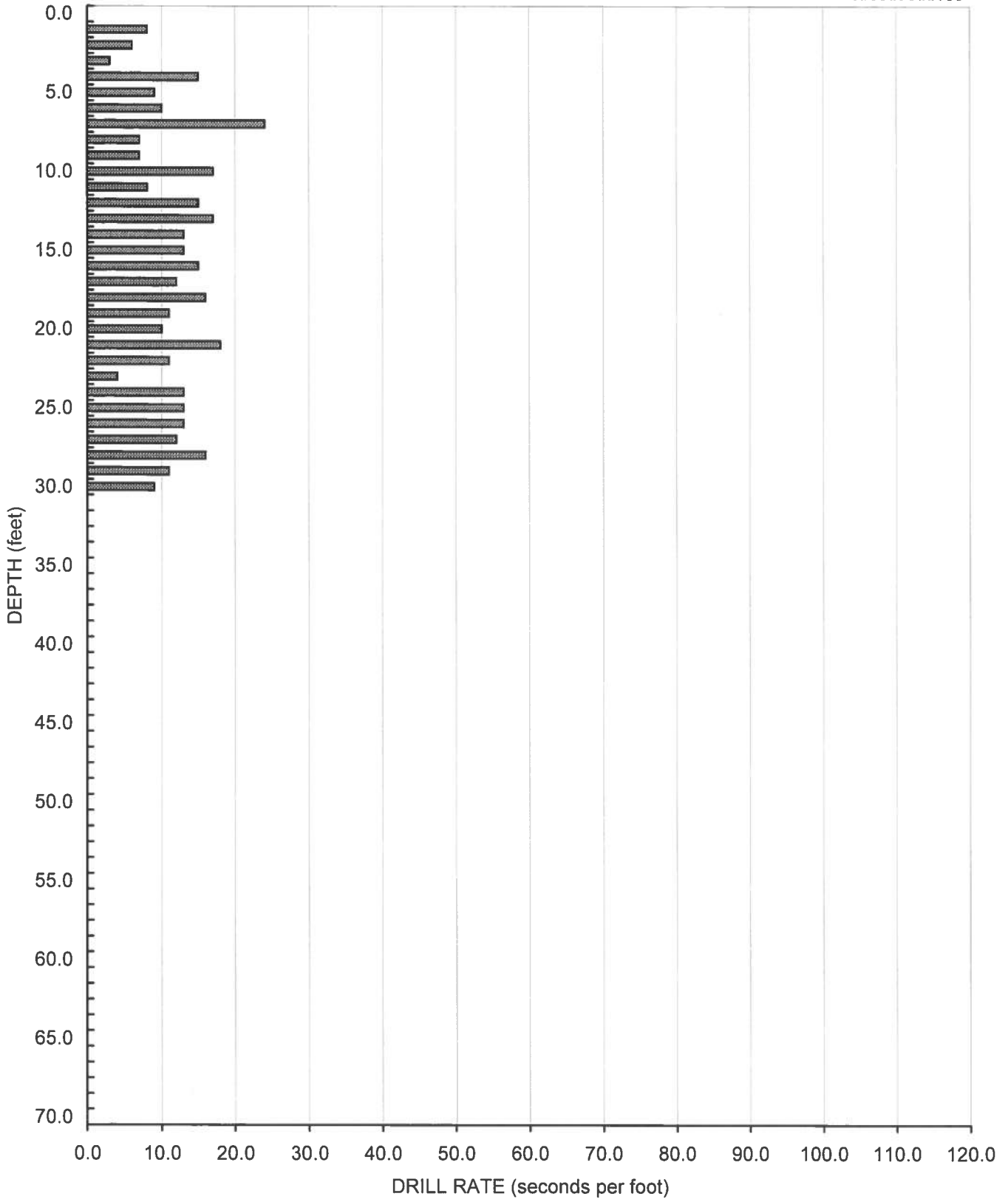

AIR TRACK BORING AT-35
Elevation - 1060 Feet (MSL)



GEOCON
INCORPORATED

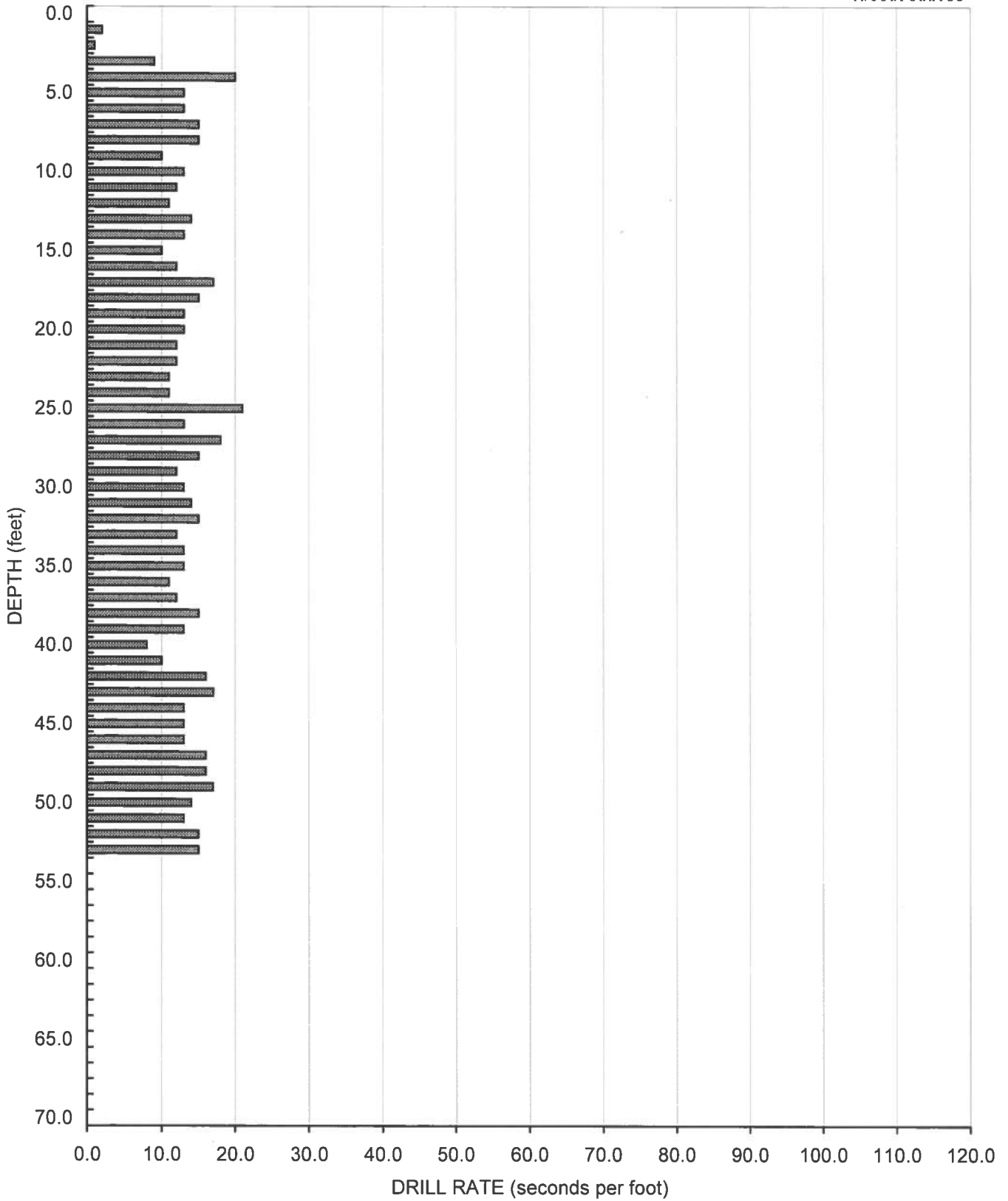

AIR TRACK BORING AT-36
Elevation - 1160 Feet (MSL)



GEOCON
INCORPORATED

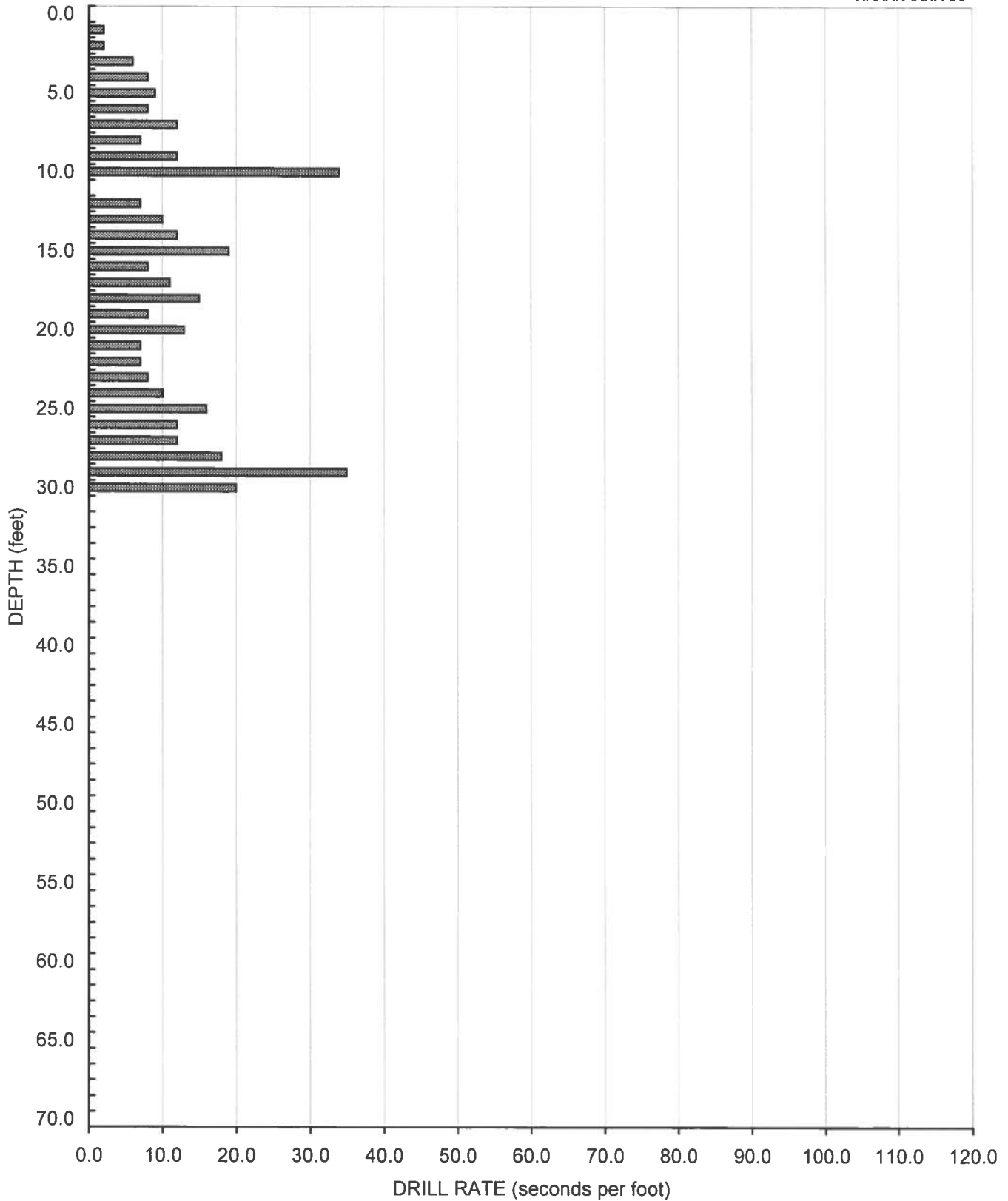

AIR TRACK BORING AT-37
Elevation - 1195 Feet (MSL)



GEOCON
INCORPORATED

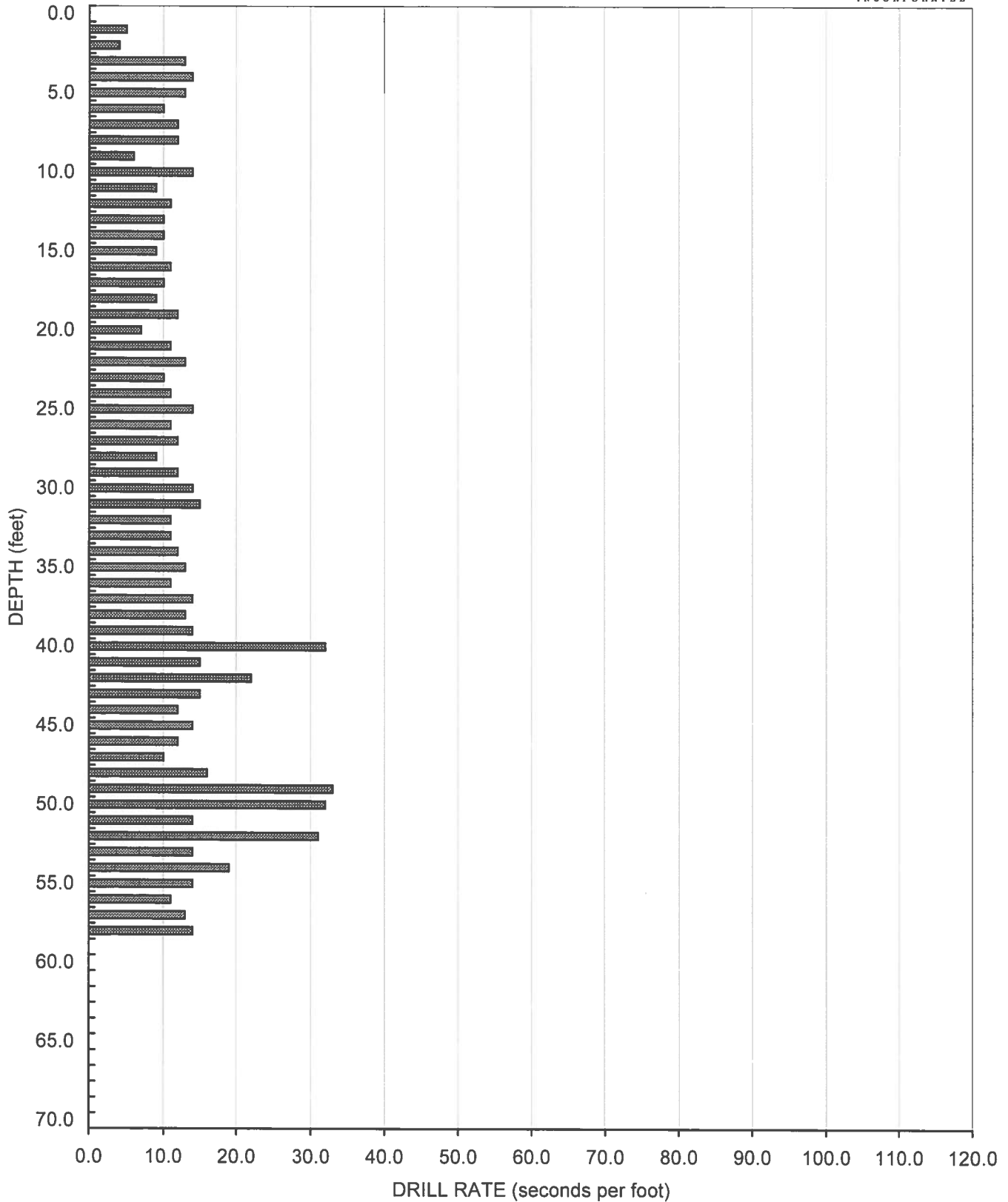

AIR TRACK BORING AT-38
Elevation - 1190 Feet (MSL)



GEOCON
INCORPORATED

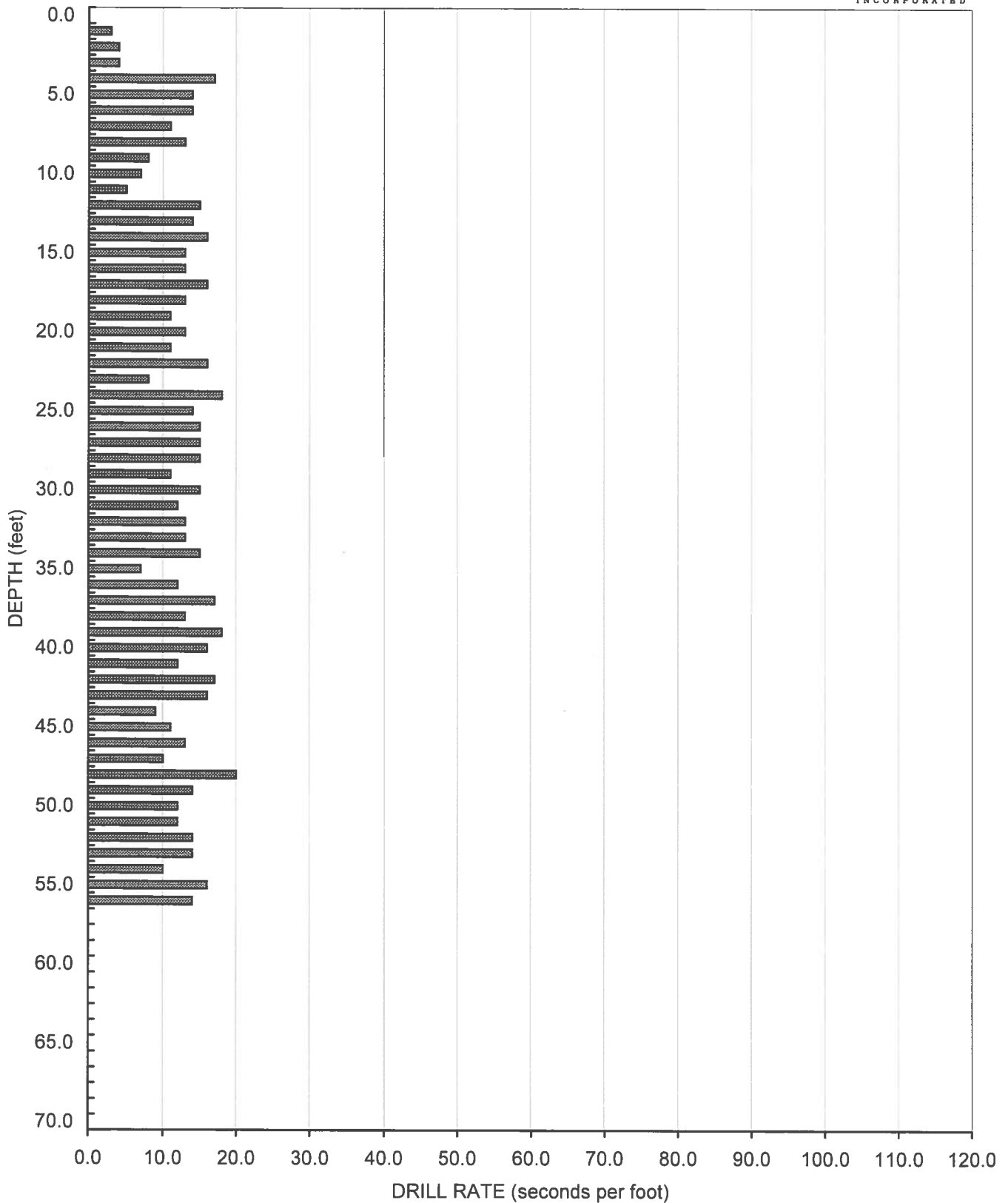

AIR TRACK BORING AT-39
Elevation - 1205 Feet (MSL)



GEOCON
INCORPORATED

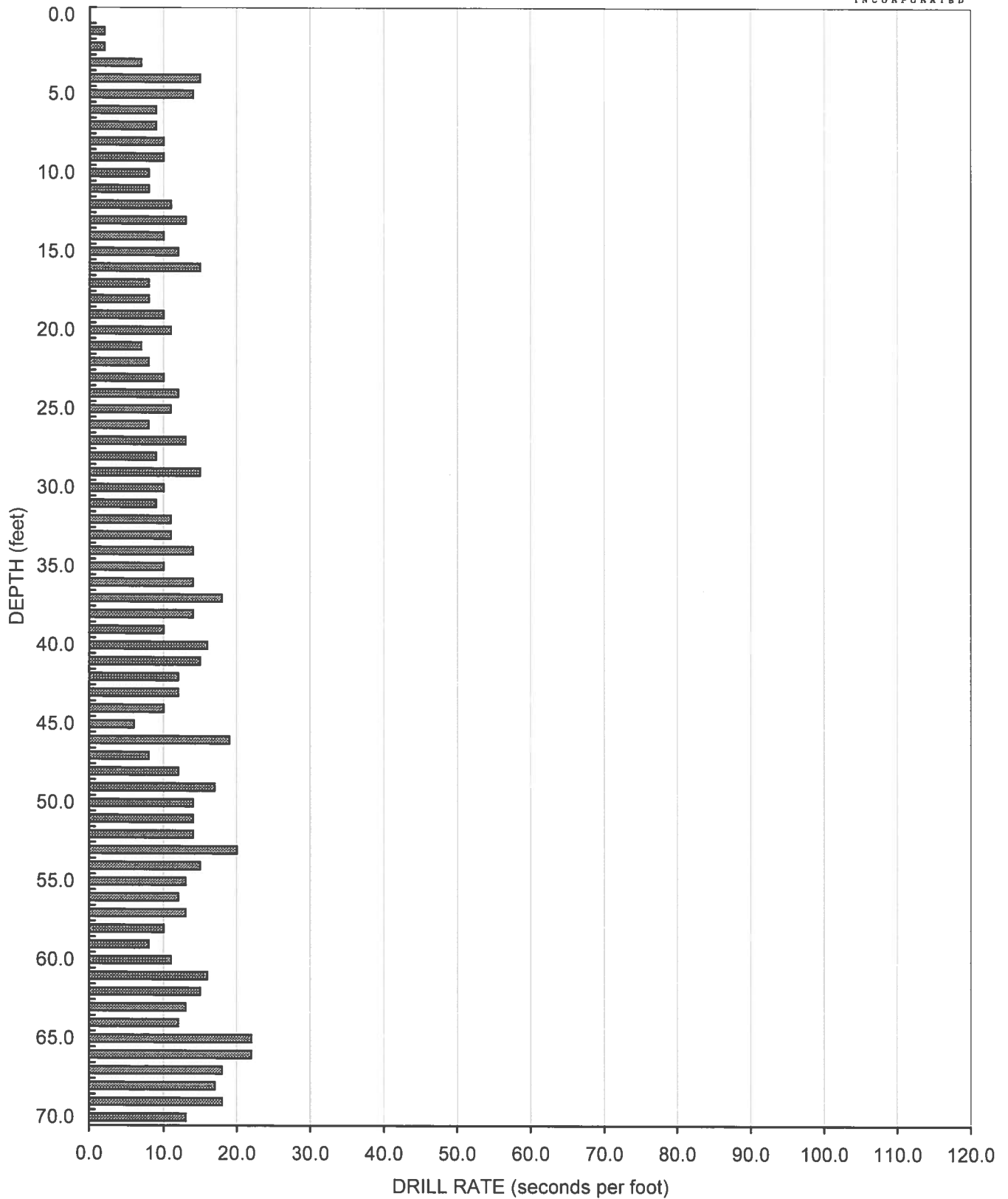

AIR TRACK BORING AT-40
Elevation - 1190 Feet (MSL)

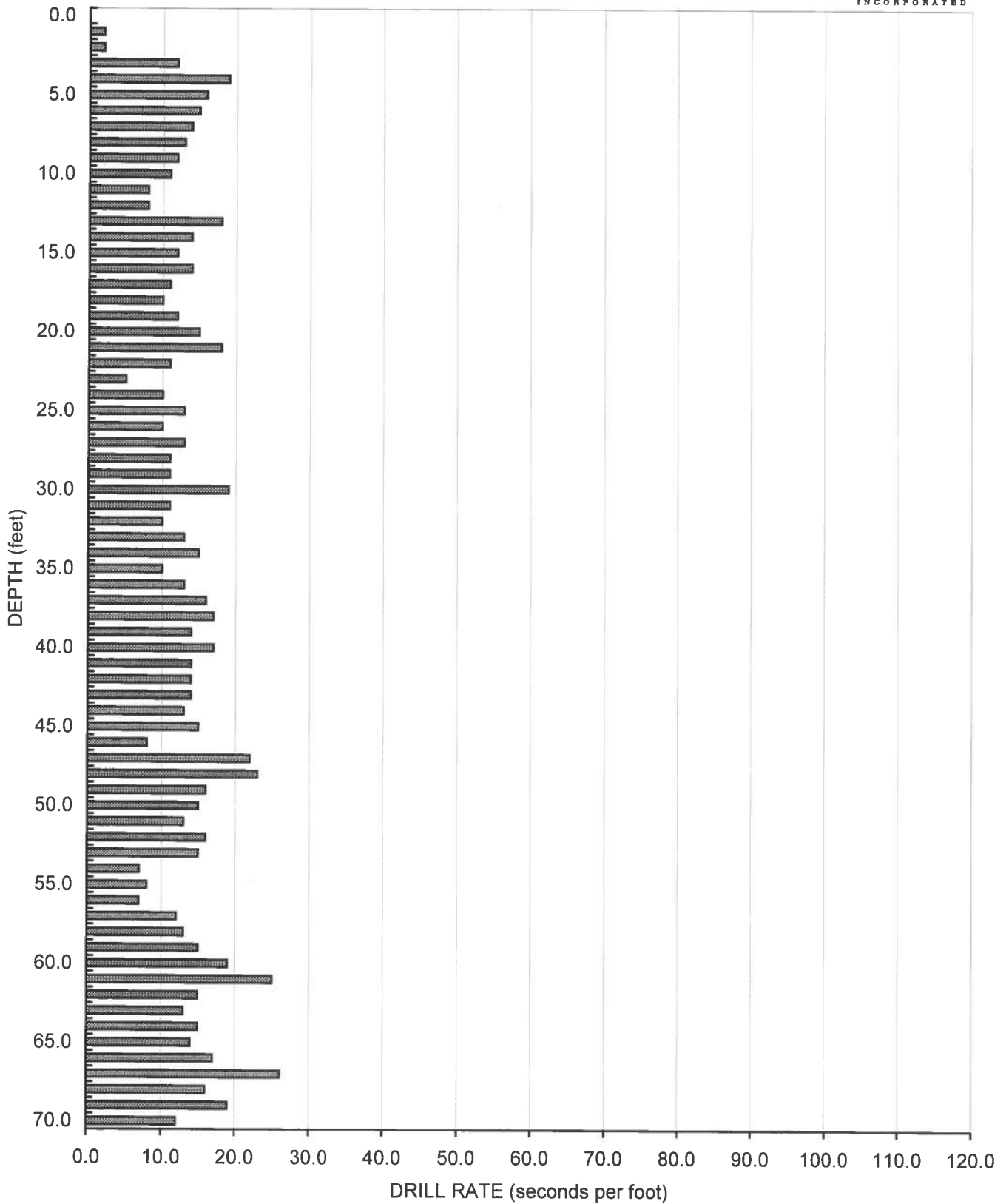

AIR TRACK BORING AT-41
Elevation - 600 Feet (MSL)



GEOCON
INCORPORATED

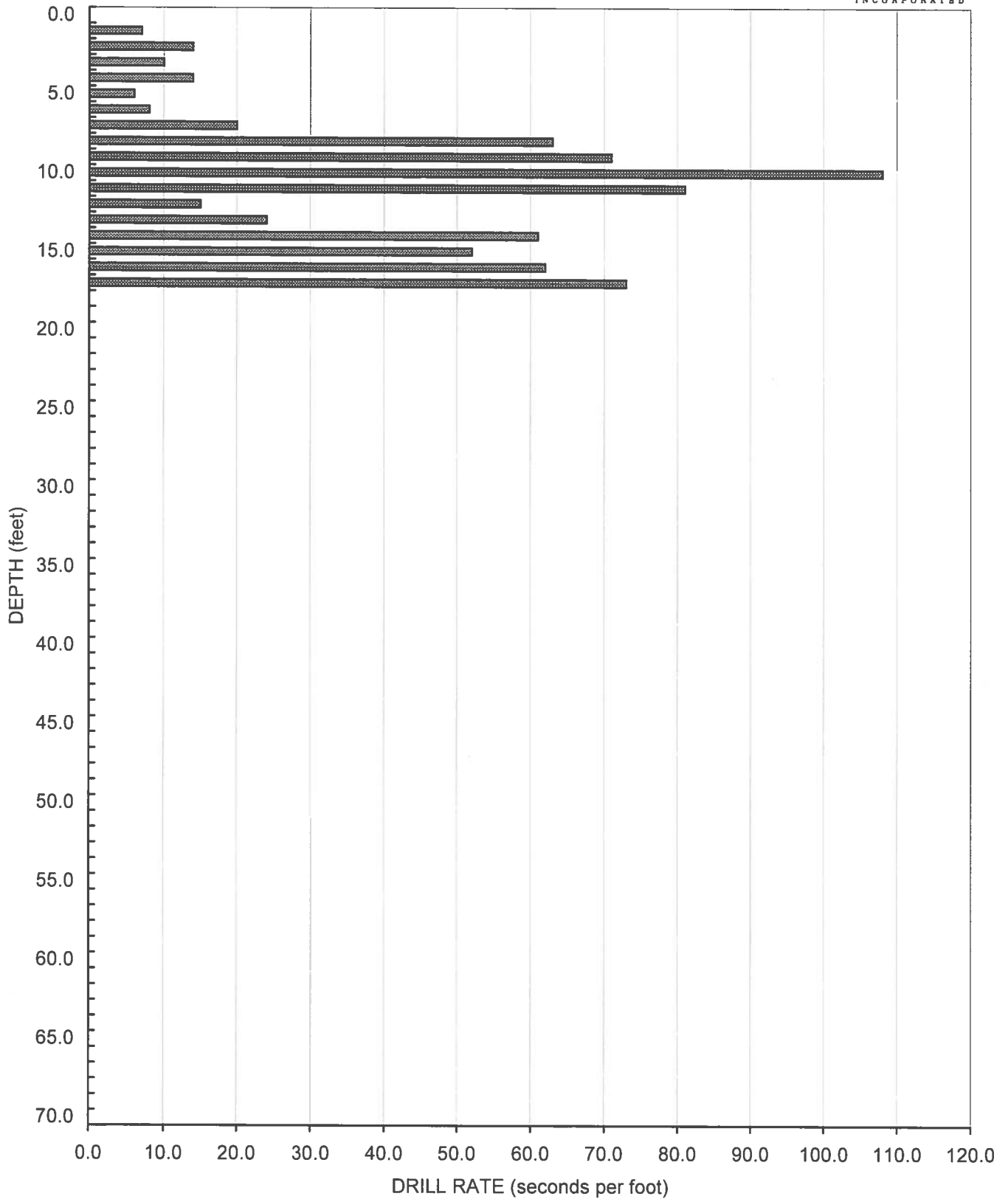

AIR TRACK BORING AT-42
Elevation - 600 Feet (MSL)



GEOCON
INCORPORATED

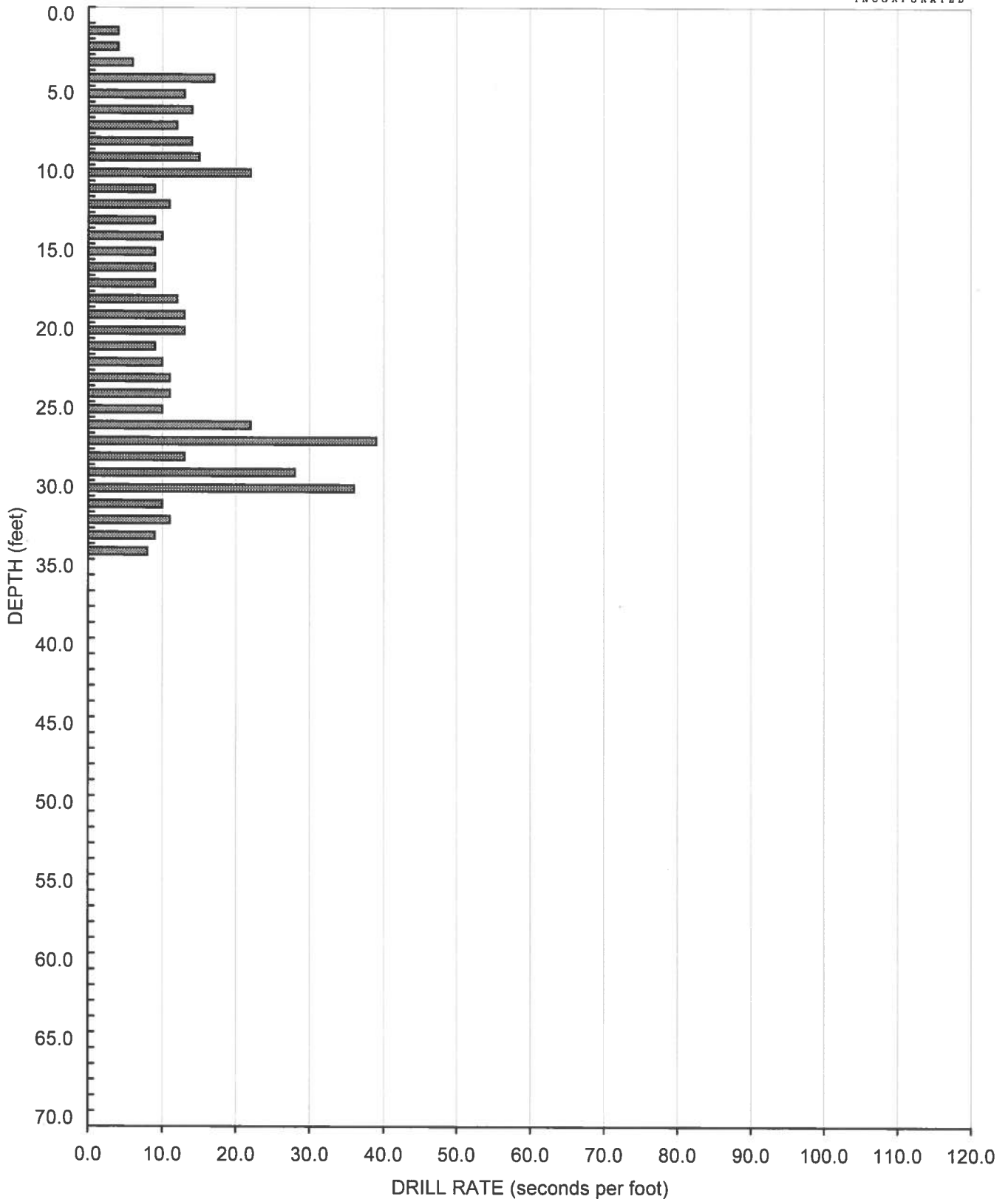

AIR TRACK BORING AT-43
Elevation - 680 Feet (MSL)



GEOCON
INCORPORATED

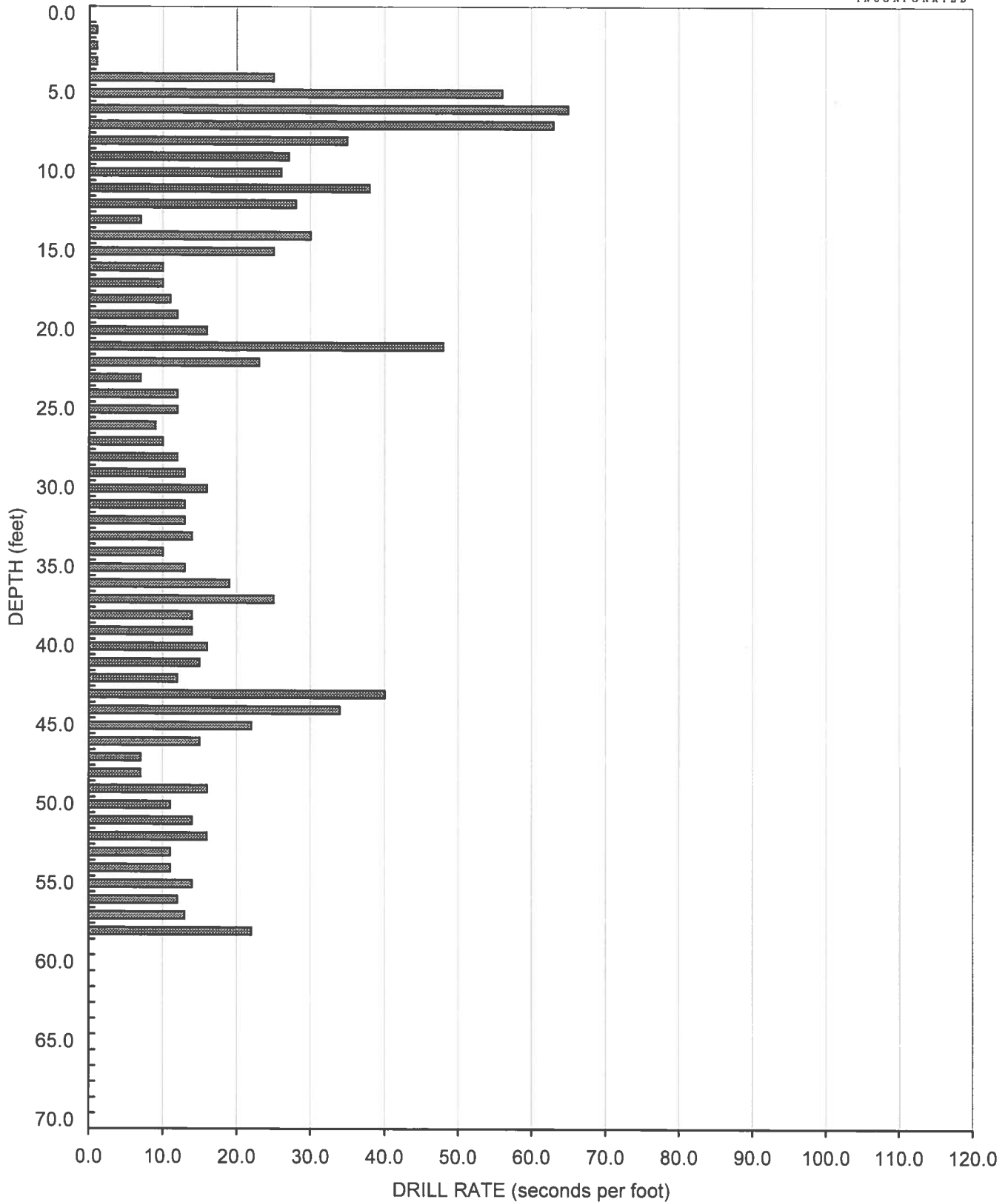

AIR TRACK BORING AT-44
Elevation - 600 Feet (MSL)



GEOCON
INCORPORATED

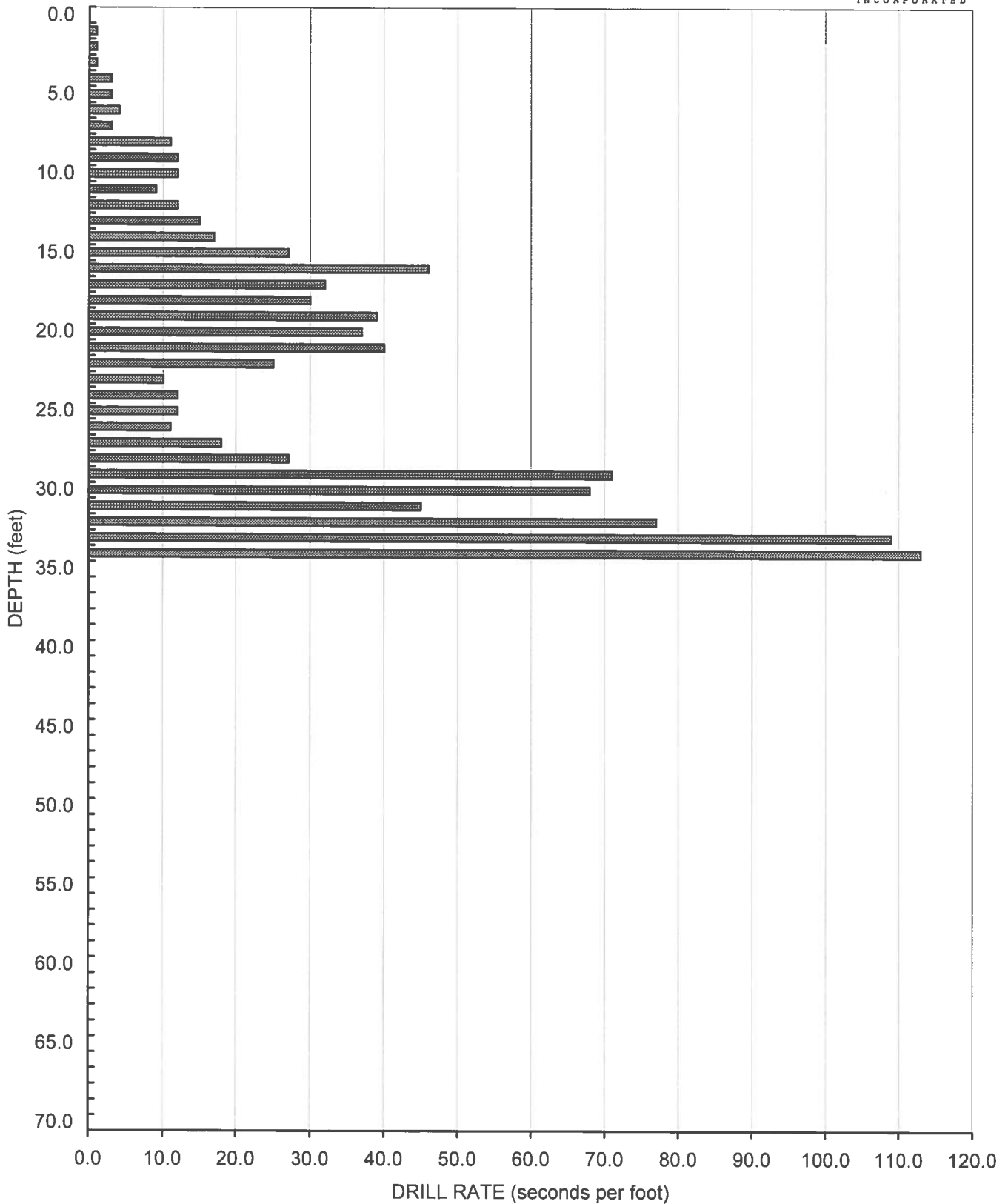

AIR TRACK BORING AT-45
Elevation - 610 Feet (MSL)



GEOCON
INCORPORATED

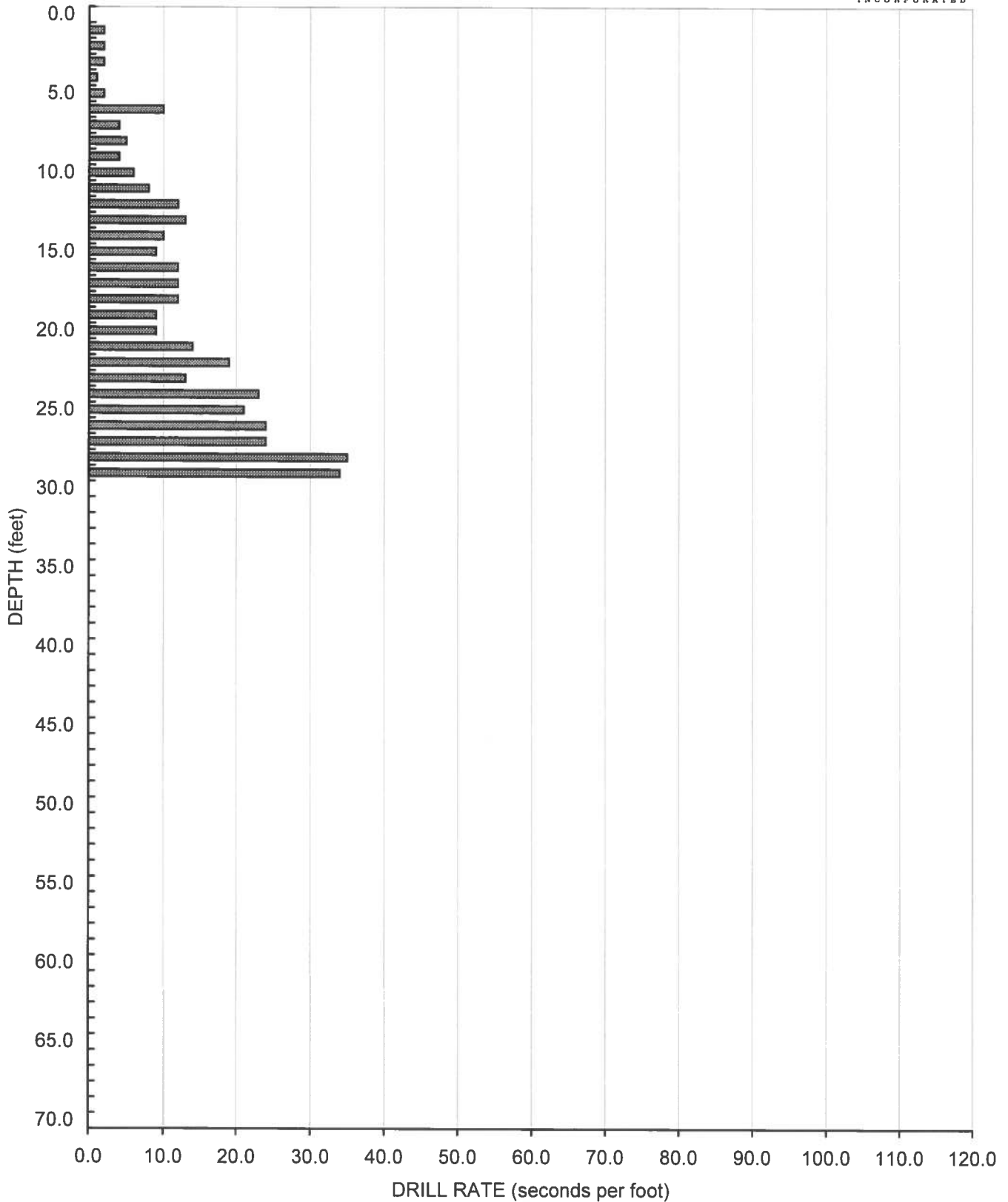

AIR TRACK BORING AT-46
Elevation - 590 Feet (MSL)



GEOCON
INCORPORATED

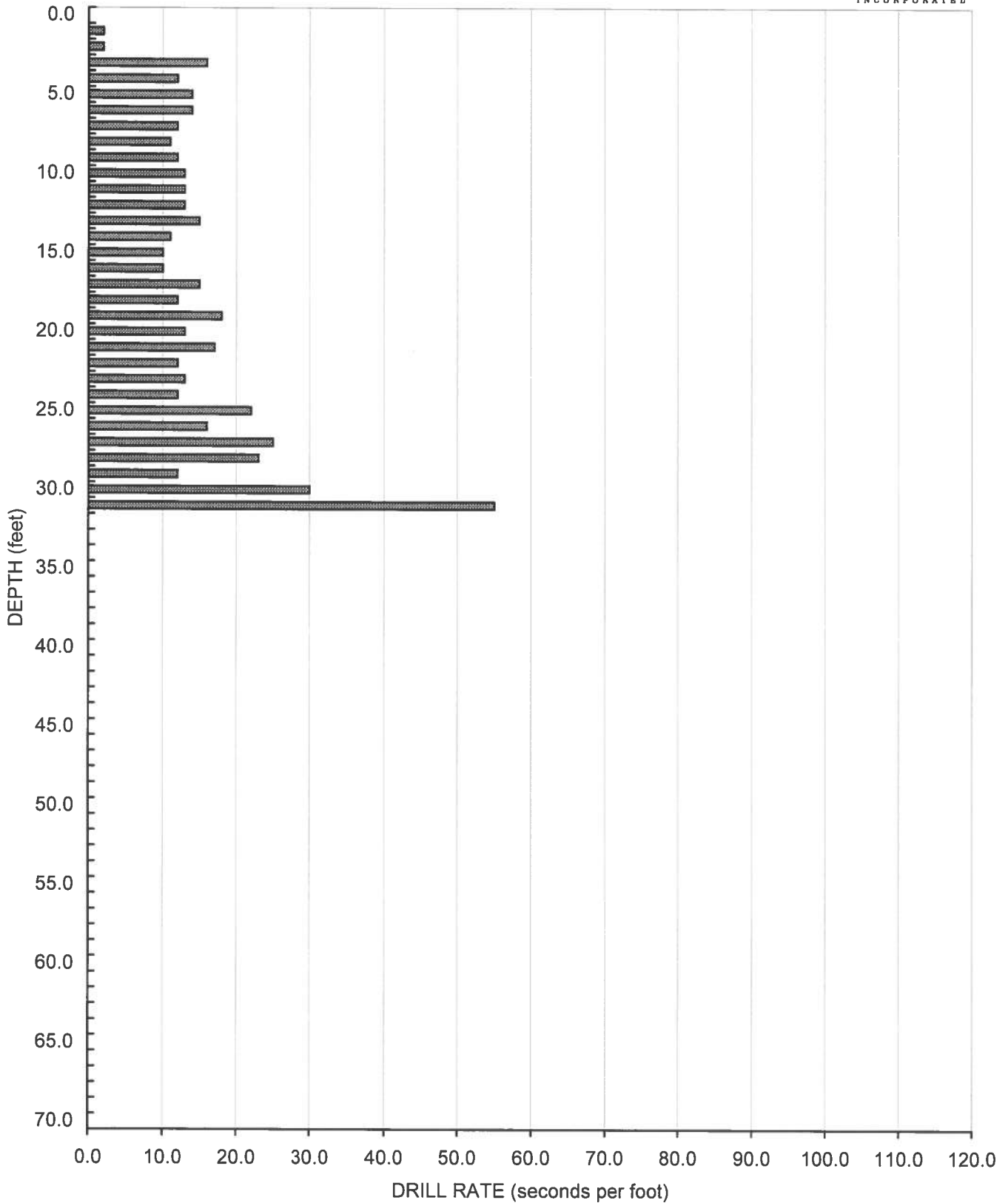

AIR TRACK BORING AT-47
Elevation - 670 Feet (MSL)



GEOCON
INCORPORATED

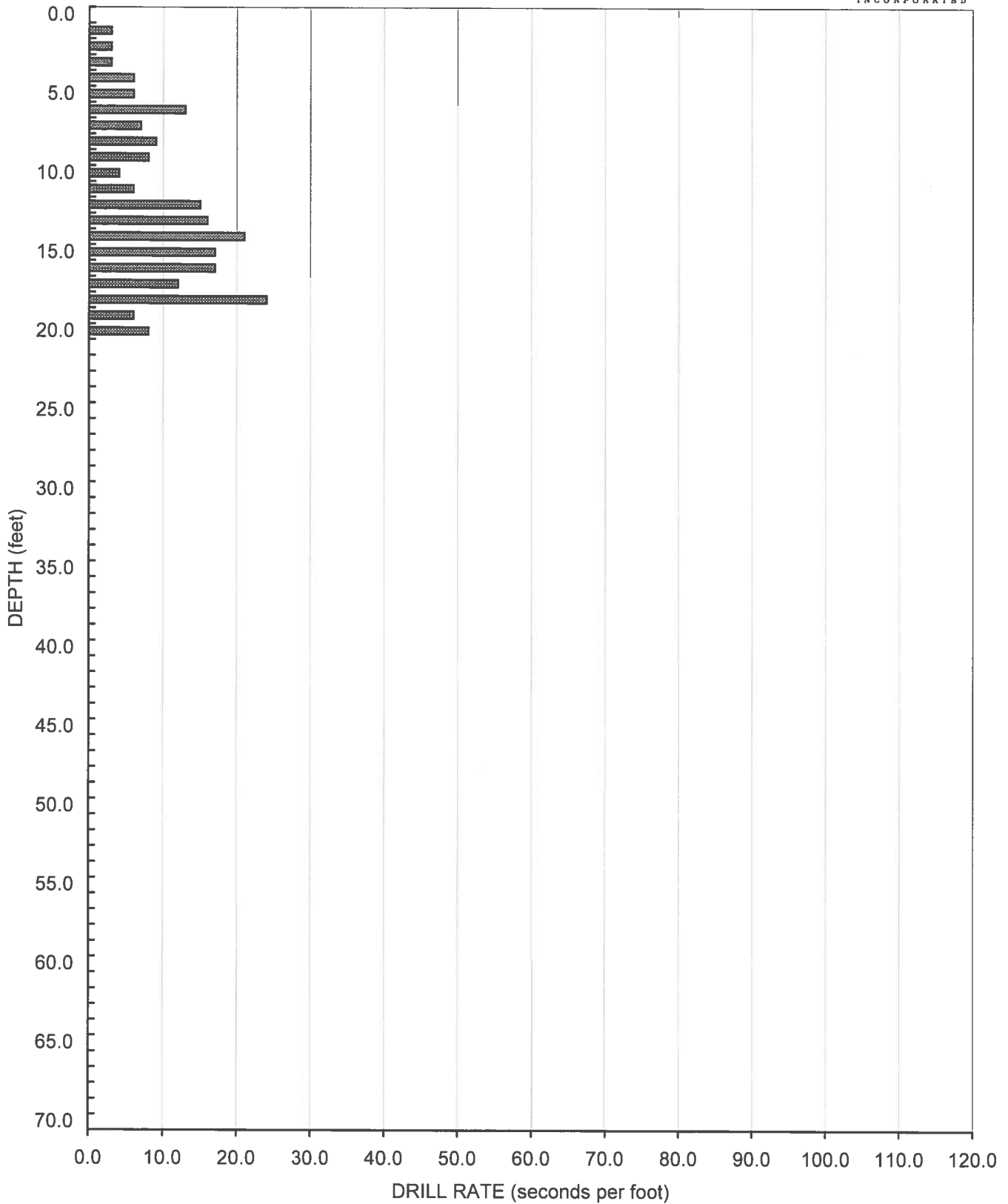

AIR TRACK BORING AT-48
Elevation - 670 Feet (MSL)



GEOCON
INCORPORATED

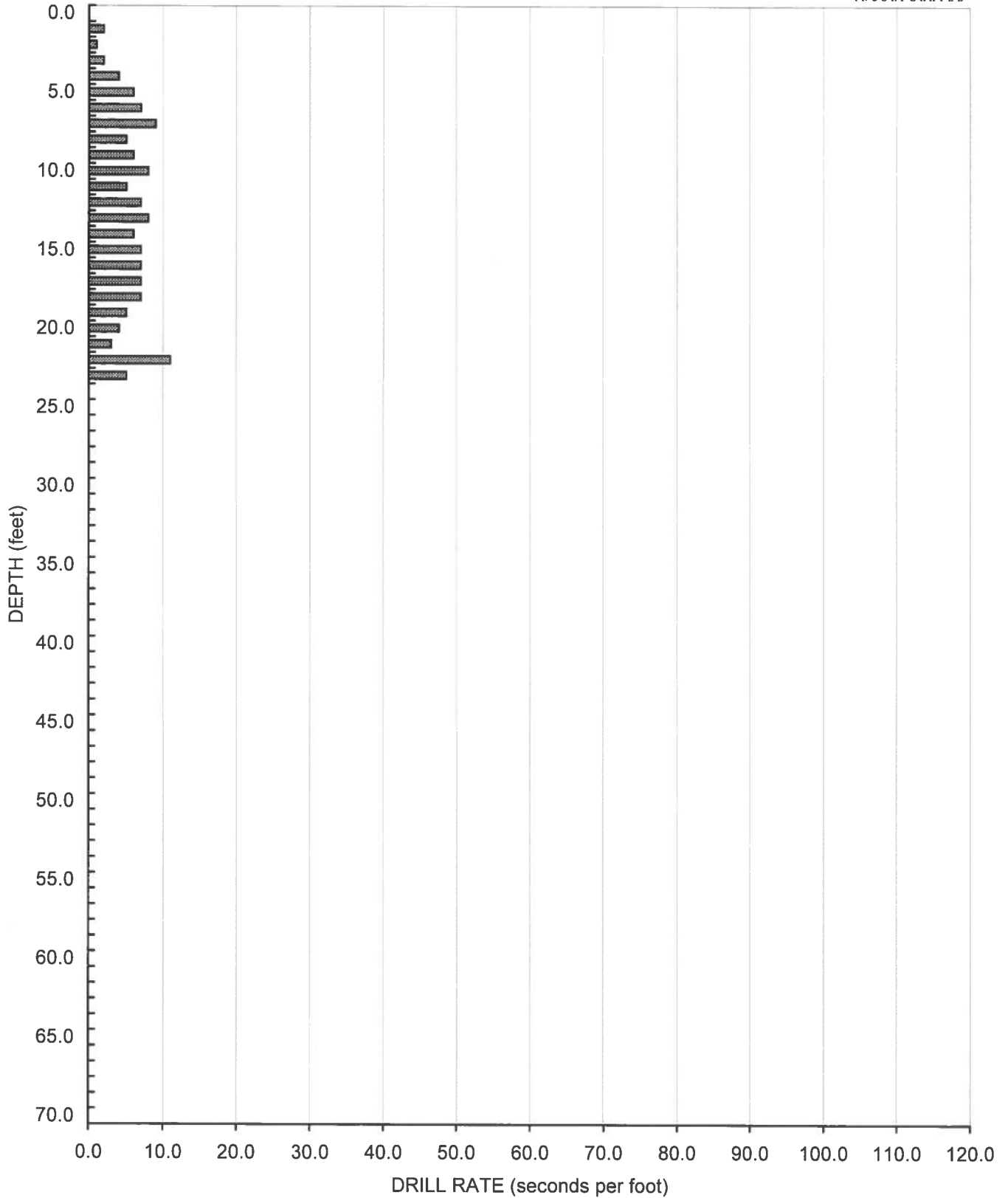

AIR TRACK BORING AT-49
Elevation - 720 Feet (MSL)



GEOCON
INCORPORATED

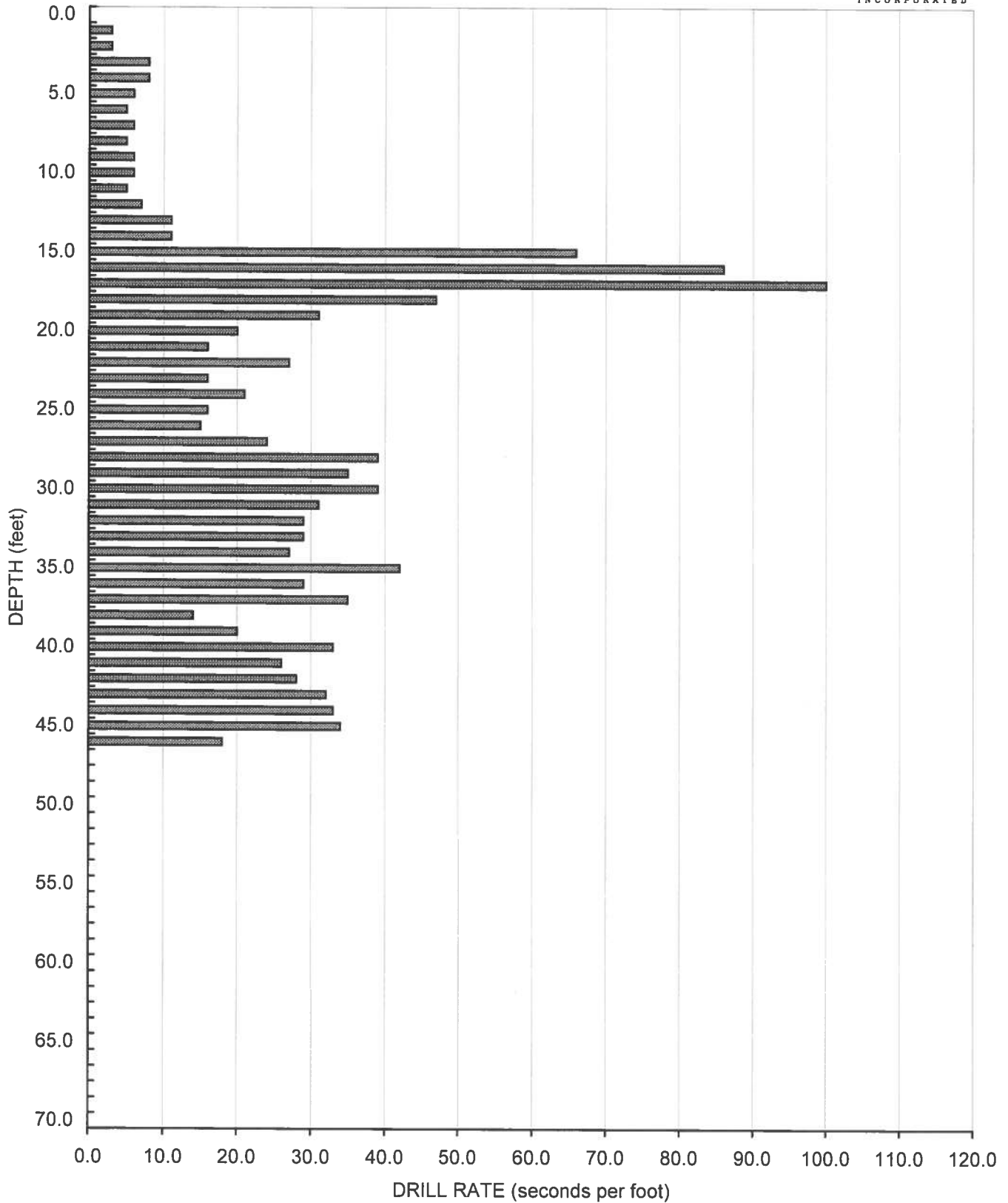

AIR TRACK BORING AT-50
Elevation - 590 Feet (MSL)



GEOCON
INCORPORATED

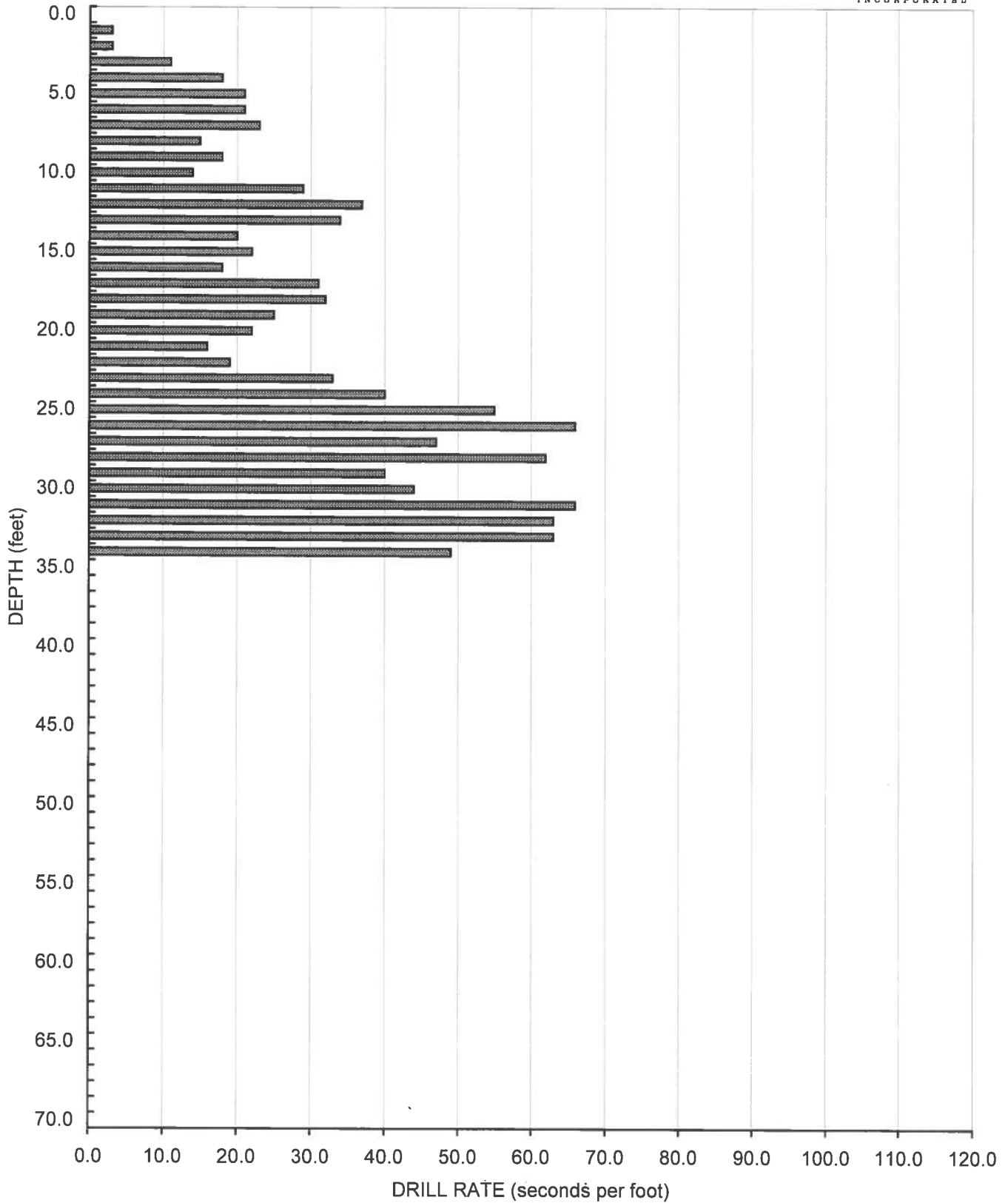

AIR TRACK BORING AT-51
Elevation - 585 Feet (MSL)



GEOCON
INCORPORATED

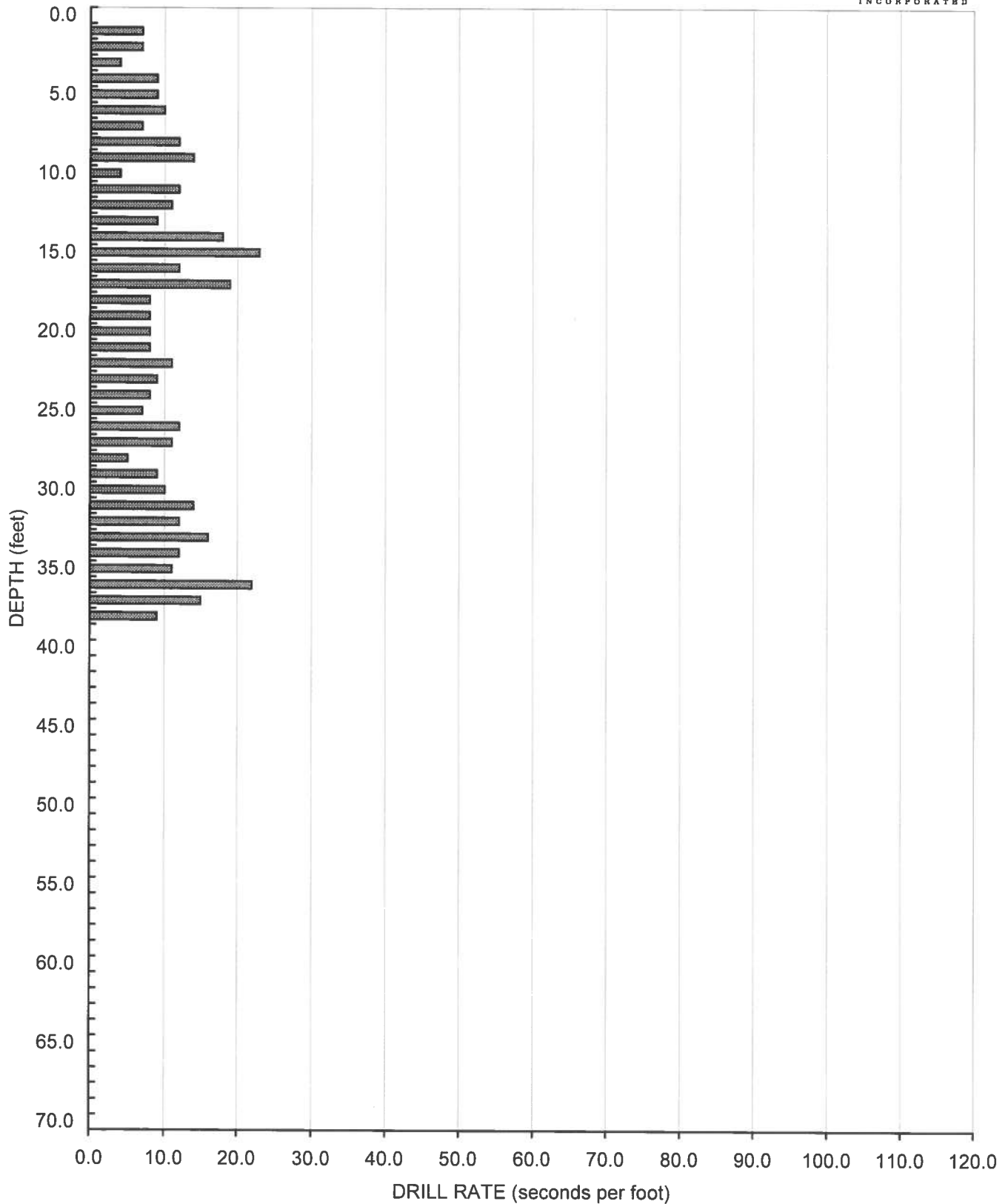

AIR TRACK BORING AT-52
Elevation - 575 Feet (MSL)



GEOCON
INCORPORATED

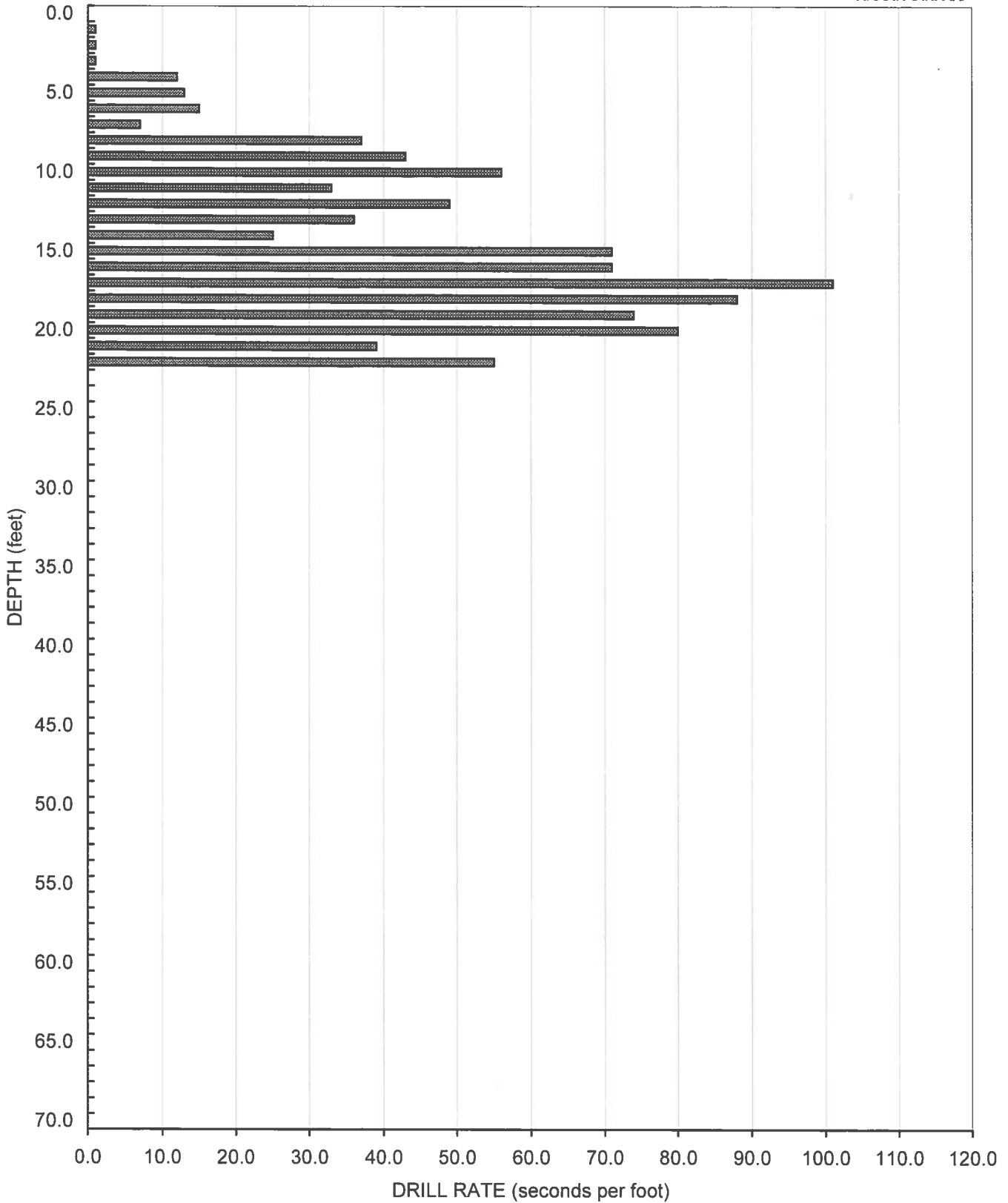

APPENDIX

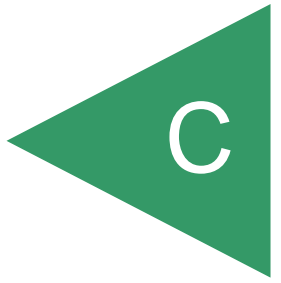

APPENDIX C

BORING, TRENCH, AND AIR-TRACK BORING LOGS (2007)

FOR

**FANITA RANCH
FANITA COMMONS, ORCHARD VILLAGE AND VINEYARD VILLAGE
SANTEE, CALIFORNIA**

PROJECT NO. 05254-32-18A

APPENDIX C

FIELD INVESTIGATION

This phase of field investigation was performed in December 2006 (reported in 2007) and consisted of a site reconnaissance and the excavation of 15 large diameter borings, 10 air-track borings, and 10 exploratory trenches. The approximate location of the subsurface explorations is shown on the *Geologic Map*.

The large-diameter borings were advanced to a maximum depth of 47 feet below existing grade using an EasyBore 120 truck-mounted drill rig equipped with a 30-inch-diameter bucket auger. Relatively undisturbed samples were obtained by driving a 3-inch, O.D., split-tube sampler into the “undisturbed” soil mass with the drill rig Kelly bar. The sampler was equipped with 1-inch by 2³/₈-inch brass sampler rings to facilitate removal and testing. Bulk samples were also obtained. The soil conditions encountered in the excavations were visually classified and logged by an engineering geologist or geotechnical engineer. In general, a dip and dip direction convention was used to present the orientation of structural features measured in the large diameter borings. The logs of the borings depicting the soil and geologic conditions encountered and the depth at which samples were obtained, are presented in Appendix C, Figures A-1 through A-15.

The backhoe trenches were advanced to a maximum depth of 13 feet either a John Deere track hoe equipped with a 24-inch-wide bucket. The soils encountered were visually examined, classified, and logged. Logs of the backhoe trenches depicting the soil and geologic conditions encountered are presented on Figures A-16 through A-25.

Air-track borings were performed with an Ingersoll Rand 370 with a 4-inch bit. The purpose of these borings was to aid in evaluating the rippability of the granitic rock exposed in potential cut areas. Air-track boring logs are presented as Figures A-26 through A-35.

DEPTH IN FEET	SAMPLE NO.	LITHOLOGY	GROUNDWATER	SOIL CLASS (USCS)	BORING B 1		PENETRATION RESISTANCE (BLOWS/FT.)	DRY DENSITY (P.C.F.)	MOISTURE CONTENT (%)
					ELEV. (MSL.) <u>476'</u>	DATE COMPLETED <u>12-07-2006</u>			
					EQUIPMENT <u>30" BUCKET AUGER</u>		BY: <u>T. REIST</u>		
MATERIAL DESCRIPTION									
0				SM	UNDOCUMENTED FILL Loose, damp, dark brown, Gravelly, fine to medium SAND, with trace clay, with 30 to 40% gravel and cobble up to 16-inches				
2									
4									
6	B1-1								
8				GP/SP	ALLUVIUM Loose, moist, brown to dark brown, Sandy GRAVEL/Gravelly SAND, with gravel and cobble up to 6-inches (low cohesion; boring belled out to twice the diameter between 8 and 13 feet)				
10	B1-2								
12	B1-3								
14	B1-4			CL	TERRACE DEPOSIT Very stiff to hard, moist, mottled pale green and brown, Silty CLAYSTONE -Becomes more competent and hard below 15 feet		PUSH		
16	B1-5								
18	B1-6						PUSH	93.0	28.5
20	B1-7								
22	B1-8								
24				SC	FRIARS FORMATION Dense, moist, mottled maroon and pale green and brown, Clayey, fine to coarse SANDSTONE				
26	B1-9								
28				CL	Hard, moist, mottled green and maroon, fine to coarse, Sandy CLAYSTONE -High angle fracture with 1/4-thick, soft, moist, pale green, poorly remolded clay gouge along trace (43, S40W) terminates at 29 1/2 feet				
30	B1-10								
	B1-11								

Figure A-1,
Log of Boring B 1, Page 1 of 2

05254-32-13.GPJ

SAMPLE SYMBOLS	... SAMPLING UNSUCCESSFUL	... STANDARD PENETRATION TEST	... DRIVE SAMPLE (UNDISTURBED)
	... DISTURBED OR BAG SAMPLE	... CHUNK SAMPLE	... WATER TABLE OR SEEPAGE

NOTE: THE LOG OF SUBSURFACE CONDITIONS SHOWN HEREON APPLIES ONLY AT THE SPECIFIC BORING OR TRENCH LOCATION AND AT THE DATE INDICATED. IT IS NOT WARRANTED TO BE REPRESENTATIVE OF SUBSURFACE CONDITIONS AT OTHER LOCATIONS AND TIMES.

DEPTH IN FEET	SAMPLE NO.	LITHOLOGY	GROUNDWATER	SOIL CLASS (USCS)	BORING B 1			PENETRATION RESISTANCE (BLOWS/FT.)	DRY DENSITY (P.C.F.)	MOISTURE CONTENT (%)
					ELEV. (MSL.) <u>476'</u>	DATE COMPLETED <u>12-07-2006</u>	EQUIPMENT <u>30" BUCKET AUGER</u> BY: <u>T. REIST</u>			
MATERIAL DESCRIPTION										
32			▼	CL	-Unable to log below 33 feet due to static water level					
34	B1-12									5
36	B1-13									
38										
40	B1-14									
42	B1-15				-Slow drilling below 42 feet			15	114.0	15.6
44										
46	B1-16						6	98.7	24.7	
46	B1-17				-Difficult drilling below 46 feet					
PRACTICAL REFUSAL AT 47 FEET										

Figure A-1,
Log of Boring B 1, Page 2 of 2

05254-32-13.GPJ

SAMPLE SYMBOLS	 ... SAMPLING UNSUCCESSFUL	 ... STANDARD PENETRATION TEST	 ... DRIVE SAMPLE (UNDISTURBED)
	 ... DISTURBED OR BAG SAMPLE	 ... CHUNK SAMPLE	 ... WATER TABLE OR SEEPAGE

NOTE: THE LOG OF SUBSURFACE CONDITIONS SHOWN HEREON APPLIES ONLY AT THE SPECIFIC BORING OR TRENCH LOCATION AND AT THE DATE INDICATED. IT IS NOT WARRANTED TO BE REPRESENTATIVE OF SUBSURFACE CONDITIONS AT OTHER LOCATIONS AND TIMES.

DEPTH IN FEET	SAMPLE NO.	LITHOLOGY	GROUNDWATER	SOIL CLASS (USCS)	BORING B 2			PENETRATION RESISTANCE (BLOWS/FT.)	DRY DENSITY (P.C.F.)	MOISTURE CONTENT (%)
					ELEV. (MSL.) <u>478'</u>	DATE COMPLETED <u>12-07-2006</u>	EQUIPMENT <u>30" BUCKET AUGER</u> BY: <u>T. REIST</u>			
MATERIAL DESCRIPTION										
0	B2-1			SM	ALLUVIUM Loose, damp, dark brown, Silty, fine to medium SAND, with some gravel					
2					-Becomes moist with increase in clay content					
4	B2-2			SM	Medium dense, moist to wet, brown to dark brown, Gravelly, fine to coarse SAND, with clay and 30 to 40% gravel and cobble up to 16-inches (pockets of lower cohesion material present; boring belled out from 6 to 16 feet)	1/6"	85.9	13.5		
6	B2-3									
8					-Moderate seepage on east sidewall					
10	B2-4									
12										
14					-Auger used below 14 feet due to difficult drilling					
16					*Unable to accurately describe area below 16 feet due to rising water level and caving material above					
18	B2-5			CL	FRIARS FORMATION Very stiff, weathered, moist, pale green, Silty CLAYSTONE, with 1 to 1½-inch thick highly plastic clay lense					
20	B2-6				-Becomes hard and less weathered below 18 feet	1	81.4	39.9		
22					-Unable to log below 22 feet due to static water level					
24	B2-7				GRANITIC ROCK Highly weathered, dark green, moderately strong GRANITIC ROCK					
26	B2-8					8				
PRACTICAL REFUSAL AT 26 FEET										

Figure A-2,
Log of Boring B 2, Page 1 of 1

05254-32-13.GPJ

SAMPLE SYMBOLS		... SAMPLING UNSUCCESSFUL		... STANDARD PENETRATION TEST		... DRIVE SAMPLE (UNDISTURBED)
		... DISTURBED OR BAG SAMPLE		... CHUNK SAMPLE		... WATER TABLE OR SEEPAGE

NOTE: THE LOG OF SUBSURFACE CONDITIONS SHOWN HEREON APPLIES ONLY AT THE SPECIFIC BORING OR TRENCH LOCATION AND AT THE DATE INDICATED. IT IS NOT WARRANTED TO BE REPRESENTATIVE OF SUBSURFACE CONDITIONS AT OTHER LOCATIONS AND TIMES.

DEPTH IN FEET	SAMPLE NO.	LITHOLOGY	GROUNDWATER	BORING B 3		PENETRATION RESISTANCE (BLOWS/FT.)	DRY DENSITY (P.C.F.)	MOISTURE CONTENT (%)
				SOIL CLASS (USCS)	ELEV. (MSL.) <u>488'</u> DATE COMPLETED <u>12-07-2006</u> EQUIPMENT <u>30" BUCKET AUGER</u> BY: <u>T. REIST</u>			
MATERIAL DESCRIPTION								
0				CL	TOPSOIL Very stiff, moist, dark brown, Gravelly CLAY, with sand and 30 to 40% gravel and cobble up to 12-inches			
2								
4				CL	TERRACE DEPOSIT Hard, moist, mottled pale green and brown, fine, Sandy CLAY			
6	B3-1 B3-2					1	91.4	30.8
8								
10	B3-3 B3-4 B3-5			SM	Dense, damp, mottled brown and pale green, Silty, fine to medium SAND, with random sandy clay lenses throughout; manganese staining present on micro fractures	3		
12								
14								
16	B3-6		▼		-Moderate seepage at 15 feet	2	93.2	29.0
18								
20				CL	FRIARS FORMATION Hard, moist, mottled pale green and maroon, Silty CLAYSTONE; slightly fissured and weak below contact			
22								
24	B3-7							
	B3-8				BORING TERMINATED AT 25 FEET	1	91.7	30.4

Figure A-3,
Log of Boring B 3, Page 1 of 1

05254-32-13.GPJ

SAMPLE SYMBOLS	 ... SAMPLING UNSUCCESSFUL	 ... STANDARD PENETRATION TEST	 ... DRIVE SAMPLE (UNDISTURBED)
	 ... DISTURBED OR BAG SAMPLE	 ... CHUNK SAMPLE	 ... WATER TABLE OR SEEPAGE

NOTE: THE LOG OF SUBSURFACE CONDITIONS SHOWN HEREON APPLIES ONLY AT THE SPECIFIC BORING OR TRENCH LOCATION AND AT THE DATE INDICATED. IT IS NOT WARRANTED TO BE REPRESENTATIVE OF SUBSURFACE CONDITIONS AT OTHER LOCATIONS AND TIMES.

DEPTH IN FEET	SAMPLE NO.	LITHOLOGY	GROUNDWATER	SOIL CLASS (USCS)	BORING B 4			PENETRATION RESISTANCE (BLOWS/FT.)	DRY DENSITY (P.C.F.)	MOISTURE CONTENT (%)
					ELEV. (MSL.) <u>478'</u>	DATE COMPLETED <u>12-08-2006</u>	EQUIPMENT <u>30" BUCKET AUGER</u> BY: <u>T. REIST</u>			
MATERIAL DESCRIPTION										
0				SM	UNDOCUMENTED FILL Loose, dry to damp, dark brown, Gravelly, fine to coarse SAND, with 30 to 40% gravel and cobble up to 16-inches					
2										
4										
6				SM	ALLUVIUM Medium dense, damp, reddish brown, Gravelly, fine to coarse SAND, with 30 to 40% gravel and cobble up to 12-inches					
8										
10	B4-1			MH	TERRACE DEPOSIT Hard, moist, mottled pale green and brown, Clayey SILT, with interbedded Clayey/Silty, fine to medium SAND lenses throughout	1	88.7	31.9		
12	B4-2									
14	B4-3									
16	B4-4				-Becomes very hard below 16 feet -Seepage first encountered at 17 feet and increases moderately with depth	2	99.2	24.9		
18										
20	B4-5					2	93.0	29.4		
22										
24										
26	B4-6			MH	FRIARS FORMATION Hard, moist, pale green, Clayey SILTSTONE; weak and moderately fissured in areas	1	91.7	31.3		
28	B4-7									
30	B4-8				-Pockets of sandy claystone present below 30 feet	2	97.5	26.7		

Figure A-4,
Log of Boring B 4, Page 1 of 2

05254-32-13.GPJ

SAMPLE SYMBOLS	 ... SAMPLING UNSUCCESSFUL	 ... STANDARD PENETRATION TEST	 ... DRIVE SAMPLE (UNDISTURBED)
	 ... DISTURBED OR BAG SAMPLE	 ... CHUNK SAMPLE	 ... WATER TABLE OR SEEPAGE

NOTE: THE LOG OF SUBSURFACE CONDITIONS SHOWN HEREON APPLIES ONLY AT THE SPECIFIC BORING OR TRENCH LOCATION AND AT THE DATE INDICATED. IT IS NOT WARRANTED TO BE REPRESENTATIVE OF SUBSURFACE CONDITIONS AT OTHER LOCATIONS AND TIMES.

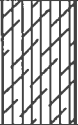
DEPTH IN FEET	SAMPLE NO.	LITHOLOGY	GROUNDWATER	BORING B 4		PENETRATION RESISTANCE (BLOWS/FT.)	DRY DENSITY (P.C.F.)	MOISTURE CONTENT (%)
				ELEV. (MSL.) <u>478'</u>	DATE COMPLETED <u>12-08-2006</u>			
					EQUIPMENT <u>30" BUCKET AUGER</u>			BY: <u>T. REIST</u>
					MATERIAL DESCRIPTION			
32				MH	-Unable to log below 32 feet due to static water level			
34					BORING TERMINATED AT 35 FEET			

**Figure A-4,
Log of Boring B 4, Page 2 of 2**

05254-32-13.GPJ

SAMPLE SYMBOLS		... SAMPLING UNSUCCESSFUL		... STANDARD PENETRATION TEST		... DRIVE SAMPLE (UNDISTURBED)
		... DISTURBED OR BAG SAMPLE		... CHUNK SAMPLE		... WATER TABLE OR SEEPAGE

NOTE: THE LOG OF SUBSURFACE CONDITIONS SHOWN HEREON APPLIES ONLY AT THE SPECIFIC BORING OR TRENCH LOCATION AND AT THE DATE INDICATED. IT IS NOT WARRANTED TO BE REPRESENTATIVE OF SUBSURFACE CONDITIONS AT OTHER LOCATIONS AND TIMES.

DEPTH IN FEET	SAMPLE NO.	LITHOLOGY	GROUNDWATER	SOIL CLASS (USCS)	BORING B 5			PENETRATION RESISTANCE (BLOWS/FT.)	DRY DENSITY (P.C.F.)	MOISTURE CONTENT (%)
					ELEV. (MSL.) <u>475'</u>	DATE COMPLETED <u>12-08-2006</u>	EQUIPMENT <u>30" BUCKET AUGER</u> BY: <u>T. REIST</u>			
MATERIAL DESCRIPTION										
0	B5-1			SM	ALLUVIUM Medium dense, damp to moist, dark brown, Silty, fine to medium SAND, with some gravel					
2										
4				GM	Medium dense, damp, brown, fine to coarse, Sandy GRAVEL, with 50 to 60% gravel and cobble up to 8-inches					
6										
8	B5-2			CL	FRIARS FORMATION Stiff, weathered, moist, olive green, CLAY; highly plastic -Becomes hard, mottled pale green and narrow with little to no fabric at 7 feet					
10										
12	B5-3			MH	FRIARS FORMATION Hard, moist, mottled pale green and maroon, Clayey SILTSTONE -Soft plastic clay gouge present on random high angle fractures below 10 feet -Zone of very stiff, fissured claystone with minor seepage from 14 to 16 feet			1	100.4	21.7
14										
16	B5-4							PUSH	85.7	33.2
18										
20	B5-5									
22										
24	B5-6									
26										
28	B5-7									
30										
32	B5-8				GRANITIC ROCK Highly weathered, dark green, moderately weak to moderately strong GRANITIC ROCK					
34										
BORING TERMINATED AT 24 FEET										

Figure A-5,
Log of Boring B 5, Page 1 of 1

05254-32-13.GPJ

SAMPLE SYMBOLS		... SAMPLING UNSUCCESSFUL		... STANDARD PENETRATION TEST		... DRIVE SAMPLE (UNDISTURBED)
		... DISTURBED OR BAG SAMPLE		... CHUNK SAMPLE		... WATER TABLE OR SEEPAGE

NOTE: THE LOG OF SUBSURFACE CONDITIONS SHOWN HEREON APPLIES ONLY AT THE SPECIFIC BORING OR TRENCH LOCATION AND AT THE DATE INDICATED. IT IS NOT WARRANTED TO BE REPRESENTATIVE OF SUBSURFACE CONDITIONS AT OTHER LOCATIONS AND TIMES.





DEPTH IN FEET	SAMPLE NO.	LITHOLOGY	GROUNDWATER	SOIL CLASS (USCS)	BORING B 6			PENETRATION RESISTANCE (BLOWS/FT.)	DRY DENSITY (P.C.F.)	MOISTURE CONTENT (%)
					ELEV. (MSL.) <u>473'</u>	DATE COMPLETED <u>12-08-2006</u>	EQUIPMENT <u>30" BUCKET AUGER</u> BY: <u>T. REIST</u>			
MATERIAL DESCRIPTION										
0				GM	TOPSOIL Loose, dry, dark brown, Sandy GRAVEL					
2					GRANITIC ROCK Highly weathered, brown, moderately weak GRANITIC ROCK -Auger used below 4 feet -Becomes moderately weathered and moderately strong below 5 feet					
4	B6-1									
6	B6-2									
8										
PRACTICAL REFUSAL WITH AUGER AT 9 FEET										

Figure A-6,
Log of Boring B 6, Page 1 of 1

05254-32-13.GPJ

SAMPLE SYMBOLS		... SAMPLING UNSUCCESSFUL		... STANDARD PENETRATION TEST		... DRIVE SAMPLE (UNDISTURBED)
		... DISTURBED OR BAG SAMPLE		... CHUNK SAMPLE		... WATER TABLE OR SEEPAGE

NOTE: THE LOG OF SUBSURFACE CONDITIONS SHOWN HEREON APPLIES ONLY AT THE SPECIFIC BORING OR TRENCH LOCATION AND AT THE DATE INDICATED. IT IS NOT WARRANTED TO BE REPRESENTATIVE OF SUBSURFACE CONDITIONS AT OTHER LOCATIONS AND TIMES.



DEPTH IN FEET	SAMPLE NO.	LITHOLOGY	GROUNDWATER	SOIL CLASS (USCS)	BORING B 7 ELEV. (MSL.) <u>496'</u> DATE COMPLETED <u>12-08-2006</u> EQUIPMENT <u>30" BUCKET AUGER</u> BY: <u>T. REIST</u>	PENETRATION RESISTANCE (BLOWS/FT.)	DRY DENSITY (P.C.F.)	MOISTURE CONTENT (%)
MATERIAL DESCRIPTION								
0				SM	TOPSOIL Loose, dry, reddish brown, Silty SAND, with 20 to 30% gravel and cobble up to 12-inches			
2				SM	TERRACE DEPOSIT Very dense (cemented), damp, mottled reddish brown and light brown, Gravelly SANDSTONE, with 30 to 40% gravel and cobble up to 16-inches -Auger used below 3 feet			
4								
6								
8								
10					GRANITIC ROCK Moderately weathered, dark green, strong GRANITIC ROCK			
12					REFUSAL AT 12 FEET			

Figure A-7,
Log of Boring B 7, Page 1 of 1

05254-32-13.GPJ

SAMPLE SYMBOLS	 ... SAMPLING UNSUCCESSFUL	 ... STANDARD PENETRATION TEST	 ... DRIVE SAMPLE (UNDISTURBED)
	 ... DISTURBED OR BAG SAMPLE	 ... CHUNK SAMPLE	 ... WATER TABLE OR SEEPAGE

NOTE: THE LOG OF SUBSURFACE CONDITIONS SHOWN HEREON APPLIES ONLY AT THE SPECIFIC BORING OR TRENCH LOCATION AND AT THE DATE INDICATED. IT IS NOT WARRANTED TO BE REPRESENTATIVE OF SUBSURFACE CONDITIONS AT OTHER LOCATIONS AND TIMES.

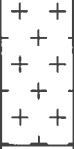
DEPTH IN FEET	SAMPLE NO.	LITHOLOGY	GROUNDWATER	SOIL CLASS (USCS)	BORING B 8		PENETRATION RESISTANCE (BLOWS/FT.)	DRY DENSITY (P.C.F.)	MOISTURE CONTENT (%)
					ELEV. (MSL.) <u>494'</u>	DATE COMPLETED <u>12-11-2006</u>			
					EQUIPMENT <u>30" BUCKET AUGER</u>		BY: <u>T. REIST</u>		
MATERIAL DESCRIPTION									
0				CL	TOPSOIL Stiff, moist, dark brown, Sandy CLAY, with 20 to 30% gravel and cobble up to 12-inches				
2	B8-1			GM	TERRACE DEPOSIT Dense, damp, light brown, Sandy GRAVEL, with 40 to 60% gravel and cobble up to 16-inches (channel deposit terminates from 4 to 7 feet; N20W)				
4				ML	FRIARS FORMATION Hard, moist, very pale green, fine Sandy SILTSTONE, with trace clay				
6				CL	Hard, moist, green, Silty CLAYSTONE; fractured with caliche stringers				
8	B8-2				-Becomes mottled green and maroon with less fracturing below 8 feet				
10	B8-3					2	96.5	25.3	
12	B8-4								
14	B8-4				-Becomes very silty with some fine sand and predominantly reddish brown with green mottling below 14 feet				
16	B8-5			ML	-Gradational contact Hard, moist, reddish brown, fine, Sandy/Clayey SILTSTONE; with random green clay filled fractures up to 2 to 3-inches wide	2	96.0	27.4	
18	B8-6				-Slight seepage at 17 feet				
20	B8-7					3	100.2	24.0	
22									
24	B8-8			SC	Dense, moist, mottled pale green and maroon, Clayey, fine to medium SANDSTONE				
26	B8-9			CL	Hard, moist, mottled pale green and maroon, very Silty CLAYSTONE	2	98.3	26.8	
28									
BORING TERMINATED AT 29 FEET									

Figure A-8,
Log of Boring B 8, Page 1 of 1

05254-32-13.GPJ

SAMPLE SYMBOLS		... SAMPLING UNSUCCESSFUL		... STANDARD PENETRATION TEST		... DRIVE SAMPLE (UNDISTURBED)
		... DISTURBED OR BAG SAMPLE		... CHUNK SAMPLE		... WATER TABLE OR SEEPAGE

NOTE: THE LOG OF SUBSURFACE CONDITIONS SHOWN HEREON APPLIES ONLY AT THE SPECIFIC BORING OR TRENCH LOCATION AND AT THE DATE INDICATED. IT IS NOT WARRANTED TO BE REPRESENTATIVE OF SUBSURFACE CONDITIONS AT OTHER LOCATIONS AND TIMES.

DEPTH IN FEET	SAMPLE NO.	LITHOLOGY	GROUNDWATER	SOIL CLASS (USCS)	BORING B 9			PENETRATION RESISTANCE (BLOWS/FT.)	DRY DENSITY (P.C.F.)	MOISTURE CONTENT (%)
					ELEV. (MSL.) <u>506'</u>	DATE COMPLETED <u>12-11-2006</u>	EQUIPMENT <u>30" BUCKET AUGER</u>			
MATERIAL DESCRIPTION										
0	B9-1			CL	TOPSOIL Stiff, moist, dark brown, fine to coarse, Sandy CLAY, with some gravel and cobble					
2										
4	B9-2			GM/SM	TERRACE DEPOSIT Dense, damp, mottled light brown and reddish orange, Sandy GRAVEL/Gravelly SAND, with 40 to 60% gravel and cobble up to 8-inches -Scoured contact					
6										
8				CL	FRIARS FORMATION Very stiff to hard, weathered, moist, mottled green and brown orange, Silty CLAY; with abundant caliche veins					
8	B9-3			MH	Hard, moist, mottled green and maroon/light brown, Clayey SILTSTONE, with random caliche veins					
10	B9-4					3	92.8	27.7		
12										
14	B9-5				-Becomes sandier from 14 to 16 feet					
16	B9-6					3				
18										
20	B9-7				-Becomes very silty with fine sand and predominantly brown with random green interbeds -Spot seeps present at 21 feet	3	93.3	29.0		
22										
22				MH	Hard, moist, mottled green and maroon, Sandy SILTSTONE, with interbedded clayey sandstone -Moderate seepage at 23 feet					
24										
26	B9-8					3	97.6	25.2		
28	B9-9									
30	B9-10					2	93.4	29.4		

Figure A-9,
Log of Boring B 9, Page 1 of 2

05254-32-13.GPJ

SAMPLE SYMBOLS		... SAMPLING UNSUCCESSFUL		... STANDARD PENETRATION TEST		... DRIVE SAMPLE (UNDISTURBED)
		... DISTURBED OR BAG SAMPLE		... CHUNK SAMPLE		... WATER TABLE OR SEEPAGE

NOTE: THE LOG OF SUBSURFACE CONDITIONS SHOWN HEREON APPLIES ONLY AT THE SPECIFIC BORING OR TRENCH LOCATION AND AT THE DATE INDICATED. IT IS NOT WARRANTED TO BE REPRESENTATIVE OF SUBSURFACE CONDITIONS AT OTHER LOCATIONS AND TIMES.



DEPTH IN FEET	SAMPLE NO.	LITHOLOGY	GROUNDWATER	BORING B 9		PENETRATION RESISTANCE (BLOWS/FT.)	DRY DENSITY (P.C.F.)	MOISTURE CONTENT (%)
				ELEV. (MSL.) <u>506'</u>	DATE COMPLETED <u>12-11-2006</u>			
				SOIL CLASS (USCS)	EQUIPMENT <u>30" BUCKET AUGER</u>			
32					MATERIAL DESCRIPTION			
34				MH				
	B9-11				BORING TERMINATED AT 35 FEET	2	92.2	30.3

Figure A-9,
Log of Boring B 9, Page 2 of 2

05254-32-13.GPJ

SAMPLE SYMBOLS	 ... SAMPLING UNSUCCESSFUL	 ... STANDARD PENETRATION TEST	 ... DRIVE SAMPLE (UNDISTURBED)
	 ... DISTURBED OR BAG SAMPLE	 ... CHUNK SAMPLE	 ... WATER TABLE OR SEEPAGE

NOTE: THE LOG OF SUBSURFACE CONDITIONS SHOWN HEREON APPLIES ONLY AT THE SPECIFIC BORING OR TRENCH LOCATION AND AT THE DATE INDICATED. IT IS NOT WARRANTED TO BE REPRESENTATIVE OF SUBSURFACE CONDITIONS AT OTHER LOCATIONS AND TIMES.

DEPTH IN FEET	SAMPLE NO.	LITHOLOGY	GROUNDWATER	SOIL CLASS (USCS)	BORING B 10			PENETRATION RESISTANCE (BLOWS/FT.)	DRY DENSITY (P.C.F.)	MOISTURE CONTENT (%)
					ELEV. (MSL.) <u>481'</u>	DATE COMPLETED <u>12-11-2006</u>	EQUIPMENT <u>30" BUCKET AUGER</u> BY: <u>T. REIST</u>			
MATERIAL DESCRIPTION										
0				SM	UNDOCUMENTED FILL Loose, damp, dark brown, Gravelly SAND, with clay and 30% gravel and cobble up to 12-inches					
2										
4										
6	B10-1			SC	ALLUVIUM Loose, moist, very dark brown, Clayey, fine to medium SAND, with some gravel -Gravel and cobble increases to 30-40% up to 16-inches below 7 feet					
8										
10					-Becomes reddish brown below 10 feet					
12					-Becomes wet below 12 feet					
14										
16	B10-2				-Moderate seepage at 16 feet					
18				CL	FRIARS FORMATION Hard, moist, mottled pale green and maroon, Silty CLAYSTONE, with interbeds of Clayey SANDSTONE					
20	B10-3					1	95.9	27.1		
22										
24										
26	B10-4					2	105.8	21.1		
28	B10-5				-Static water level at 27 feet					
30	B10-6				BORING TERMINATED AT 30 FEET	4	101.0	24.4		

Figure A-10,
Log of Boring B 10, Page 1 of 1

05254-32-13.GPJ

SAMPLE SYMBOLS	... SAMPLING UNSUCCESSFUL	... STANDARD PENETRATION TEST	... DRIVE SAMPLE (UNDISTURBED)
	... DISTURBED OR BAG SAMPLE	... CHUNK SAMPLE	... WATER TABLE OR SEEPAGE

NOTE: THE LOG OF SUBSURFACE CONDITIONS SHOWN HEREON APPLIES ONLY AT THE SPECIFIC BORING OR TRENCH LOCATION AND AT THE DATE INDICATED. IT IS NOT WARRANTED TO BE REPRESENTATIVE OF SUBSURFACE CONDITIONS AT OTHER LOCATIONS AND TIMES.

DEPTH IN FEET	SAMPLE NO.	LITHOLOGY	GROUNDWATER	SOIL CLASS (USCS)	BORING B 11			PENETRATION RESISTANCE (BLOWS/FT.)	DRY DENSITY (P.C.F.)	MOISTURE CONTENT (%)	
					ELEV. (MSL.) <u>489'</u>	DATE COMPLETED <u>12-11-2006</u>	EQUIPMENT <u>30" BUCKET AUGER</u> BY: <u>T. REIST</u>				
MATERIAL DESCRIPTION											
0	B11-1			SM	TOPSOIL Medium dense, damp, brown to reddish brown, Gravelly SAND, with clay and 30% gravel and cobble up to 8-inches						
2				GM	TERRACE DEPOSIT Dense, damp, reddish brown, Sandy GRAVEL, with 40 to 60% gravel and cobble up to 12-inches -Becomes pale green below 3½ feet						
4											
6						GRANITIC ROCK Highly weathered, brown, moderately weak to moderately strong GRANITIC ROCK; massive with no discernible fracturing or jointing					
8	B11-2										
10											
12											
14											
PRACTICAL REFUSAL AT 14 FEET											

Figure A-11,
Log of Boring B 11, Page 1 of 1

05254-32-13.GPJ

SAMPLE SYMBOLS	... SAMPLING UNSUCCESSFUL	... STANDARD PENETRATION TEST	... DRIVE SAMPLE (UNDISTURBED)
	... DISTURBED OR BAG SAMPLE	... CHUNK SAMPLE	... WATER TABLE OR SEEPAGE

NOTE: THE LOG OF SUBSURFACE CONDITIONS SHOWN HEREON APPLIES ONLY AT THE SPECIFIC BORING OR TRENCH LOCATION AND AT THE DATE INDICATED. IT IS NOT WARRANTED TO BE REPRESENTATIVE OF SUBSURFACE CONDITIONS AT OTHER LOCATIONS AND TIMES.

DEPTH IN FEET	SAMPLE NO.	LITHOLOGY	GROUNDWATER	BORING B 12		PENETRATION RESISTANCE (BLOWS/FT.)	DRY DENSITY (P.C.F.)	MOISTURE CONTENT (%)
				SOIL CLASS (USCS)	ELEV. (MSL.) <u>493'</u> DATE COMPLETED <u>12-12-2006</u>			
				EQUIPMENT <u>30" BUCKET AUGER</u> BY: <u>T. REIST</u>				
MATERIAL DESCRIPTION								
0	B12-1			SM	ALLUVIUM Loose, damp to moist, dark brown, Gravelly SAND, with clay and 20 to 30% gravel and cobble up to 14-inches -Slightly scoured contact			
2								
4								
6								
8								
10								
12								
14								
16					GRANITIC ROCK Highly weathered, brown, moderately weak to moderately strong GRANITIC ROCK; with random 1/2 to 1-inch wide clay filled high angle fractures -Moderate seepage at 13 1/2 feet -Becomes moderately weathered and strong below 15 feet			
18								
20								
20								
BORING TERMINATED AT 20 FEET								

Figure A-12,
Log of Boring B 12, Page 1 of 1

05254-32-13.GPJ

SAMPLE SYMBOLS	... SAMPLING UNSUCCESSFUL	... STANDARD PENETRATION TEST	... DRIVE SAMPLE (UNDISTURBED)
	... DISTURBED OR BAG SAMPLE	... CHUNK SAMPLE	... WATER TABLE OR SEEPAGE

NOTE: THE LOG OF SUBSURFACE CONDITIONS SHOWN HEREON APPLIES ONLY AT THE SPECIFIC BORING OR TRENCH LOCATION AND AT THE DATE INDICATED. IT IS NOT WARRANTED TO BE REPRESENTATIVE OF SUBSURFACE CONDITIONS AT OTHER LOCATIONS AND TIMES.





DEPTH IN FEET	SAMPLE NO.	LITHOLOGY	GROUNDWATER	BORING B 13		PENETRATION RESISTANCE (BLOWS/FT.)	DRY DENSITY (P.C.F.)	MOISTURE CONTENT (%)
				SOIL CLASS (USCS)	ELEV. (MSL.) <u>466'</u> DATE COMPLETED <u>12-12-2006</u> EQUIPMENT <u>30" BUCKET AUGER</u> BY: <u>T. REIST</u>			
MATERIAL DESCRIPTION								
0				CL	TOPSOIL Stiff, moist, dark brown, Sandy CLAY, with some gravel and cobble up to 12-inches			
2				SM	FRIARS FORMATION Dense, damp, reddish brown to light brown, Gravelly SANDSTONE, with 30 to 40% gravel and cobble up to 14-inches			
4								
6					GRANITIC ROCK Highly weathered to moderately weathered, brown, moderately strong to strong GRANITIC ROCK; massive, with no discernible fracturing and jointing			
8								
					PRACTICAL REFUSAL AT 9 FEET			

Figure A-13,
Log of Boring B 13, Page 1 of 1

05254-32-13.GPJ

SAMPLE SYMBOLS	 ... SAMPLING UNSUCCESSFUL	 ... STANDARD PENETRATION TEST	 ... DRIVE SAMPLE (UNDISTURBED)
	 ... DISTURBED OR BAG SAMPLE	 ... CHUNK SAMPLE	 ... WATER TABLE OR SEEPAGE

NOTE: THE LOG OF SUBSURFACE CONDITIONS SHOWN HEREON APPLIES ONLY AT THE SPECIFIC BORING OR TRENCH LOCATION AND AT THE DATE INDICATED. IT IS NOT WARRANTED TO BE REPRESENTATIVE OF SUBSURFACE CONDITIONS AT OTHER LOCATIONS AND TIMES.

DEPTH IN FEET	SAMPLE NO.	LITHOLOGY	GROUNDWATER	SOIL CLASS (USCS)	BORING B 14			PENETRATION RESISTANCE (BLOWS/FT.)	DRY DENSITY (P.C.F.)	MOISTURE CONTENT (%)
					ELEV. (MSL.) <u>487'</u>	DATE COMPLETED <u>12-12-2006</u>	EQUIPMENT <u>30" BUCKET AUGER</u> BY: <u>T. REIST</u>			
MATERIAL DESCRIPTION										
0				CL	TOPSOIL Stiff, moist, dark brown, Sandy CLAY, with some gravel					
2										
4					GRANITIC ROCK Highly weathered to moderately weathered, brown, moderately weak to moderately strong GRANITIC ROCK; massive, with some minor 1/4-inch wide fractures/joints					
6										
8										
10					-Becomes slightly weathered and strong below 10 feet					
12					REFUSAL AT 12 FEET					

Figure A-14,
Log of Boring B 14, Page 1 of 1

05254-32-13.GPJ

SAMPLE SYMBOLS	 ... SAMPLING UNSUCCESSFUL	 ... STANDARD PENETRATION TEST	 ... DRIVE SAMPLE (UNDISTURBED)
	 ... DISTURBED OR BAG SAMPLE	 ... CHUNK SAMPLE	 ... WATER TABLE OR SEEPAGE

NOTE: THE LOG OF SUBSURFACE CONDITIONS SHOWN HEREON APPLIES ONLY AT THE SPECIFIC BORING OR TRENCH LOCATION AND AT THE DATE INDICATED. IT IS NOT WARRANTED TO BE REPRESENTATIVE OF SUBSURFACE CONDITIONS AT OTHER LOCATIONS AND TIMES.

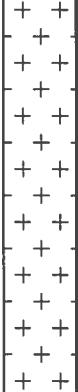
DEPTH IN FEET	SAMPLE NO.	LITHOLOGY	GROUNDWATER	BORING B 15		PENETRATION RESISTANCE (BLOWS/FT.)	DRY DENSITY (P.C.F.)	MOISTURE CONTENT (%)
				SOIL CLASS (USCS)	ELEV. (MSL.) <u>466'</u> DATE COMPLETED <u>12-12-2006</u> EQUIPMENT <u>30" BUCKET AUGER</u> BY: <u>T. REIST</u>			
MATERIAL DESCRIPTION								
0				SC	ALLUVIUM Loose to medium dense, moist, very dark brown, very Clayey, fine to medium SAND, with some gravel and cobble up to 8-inches			
2								
4	B15-1							
6	B15-2					2	116.3	15.9
8					-Becomes wet with 20 to 30% gravel and cobble up to 14-inches			
10					-Moderate seepage at contact			
12					GRANITIC ROCK Highly weathered, dark brown to dark green, moderately weak to moderately strong GRANITIC ROCK			
14								
REFUSAL AT 15 FEET								

**Figure A-15,
Log of Boring B 15, Page 1 of 1**

05254-32-13.GPJ

SAMPLE SYMBOLS		... SAMPLING UNSUCCESSFUL		... STANDARD PENETRATION TEST		... DRIVE SAMPLE (UNDISTURBED)
		... DISTURBED OR BAG SAMPLE		... CHUNK SAMPLE		... WATER TABLE OR SEEPAGE

NOTE: THE LOG OF SUBSURFACE CONDITIONS SHOWN HEREON APPLIES ONLY AT THE SPECIFIC BORING OR TRENCH LOCATION AND AT THE DATE INDICATED. IT IS NOT WARRANTED TO BE REPRESENTATIVE OF SUBSURFACE CONDITIONS AT OTHER LOCATIONS AND TIMES.



DEPTH IN FEET	SAMPLE NO.	LITHOLOGY	GROUNDWATER	SOIL CLASS (USCS)	TRENCH T 1			PENETRATION RESISTANCE (BLOWS/FT.)	DRY DENSITY (P.C.F.)	MOISTURE CONTENT (%)
					ELEV. (MSL.) <u>495'</u>	DATE COMPLETED <u>12-01-2006</u>	EQUIPMENT <u>JD TRACKHOE</u> BY: <u>T. REIST</u>			
MATERIAL DESCRIPTION										
0	T1-1			CL	TOPSOIL Stiff, moist, fine to coarse, Sandy CLAY, with trace gravel					
2					GRANITIC ROCK Highly weathered, brown, moderately weak to moderately strong GRANITIC ROCK; massive					
4	T1-2									
TRENCH TERMINATED AT 4½ FEET										

Figure A-16,
Log of Trench T 1, Page 1 of 1

05254-32-13.GPJ

SAMPLE SYMBOLS	 ... SAMPLING UNSUCCESSFUL	 ... STANDARD PENETRATION TEST	 ... DRIVE SAMPLE (UNDISTURBED)
	 ... DISTURBED OR BAG SAMPLE	 ... CHUNK SAMPLE	 ... WATER TABLE OR SEEPAGE

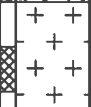
NOTE: THE LOG OF SUBSURFACE CONDITIONS SHOWN HEREON APPLIES ONLY AT THE SPECIFIC BORING OR TRENCH LOCATION AND AT THE DATE INDICATED. IT IS NOT WARRANTED TO BE REPRESENTATIVE OF SUBSURFACE CONDITIONS AT OTHER LOCATIONS AND TIMES.

DEPTH IN FEET	SAMPLE NO.	LITHOLOGY	GROUNDWATER	SOIL CLASS (USCS)	TRENCH T 2			PENETRATION RESISTANCE (BLOWS/FT.)	DRY DENSITY (P.C.F.)	MOISTURE CONTENT (%)
					ELEV. (MSL.) <u>487'</u>	DATE COMPLETED <u>12-01-2006</u>	EQUIPMENT <u>JD TRACKHOE</u> BY: <u>T. REIST</u>			
MATERIAL DESCRIPTION										
0	T2-1			GC/GM	TOPSOIL Loose, moist, dark brown, Clayey/Sandy GRAVEL, with 40 to 60% gravel and cobble					
2										
4	T2-2				GRANITIC ROCK Completely weathered to highly weathered, light brown, weak to moderately weak GRANITIC ROCK -Becomes highly weathered to moderately strong at 5½ feet					
6										
8					-Becomes moderately weathered below 8 feet					
TRENCH TERMINATED AT 9 FEET										

Figure A-17,
Log of Trench T 2, Page 1 of 1

05254-32-13.GPJ

SAMPLE SYMBOLS		... SAMPLING UNSUCCESSFUL		... STANDARD PENETRATION TEST		... DRIVE SAMPLE (UNDISTURBED)
		... DISTURBED OR BAG SAMPLE		... CHUNK SAMPLE		... WATER TABLE OR SEEPAGE

NOTE: THE LOG OF SUBSURFACE CONDITIONS SHOWN HEREON APPLIES ONLY AT THE SPECIFIC BORING OR TRENCH LOCATION AND AT THE DATE INDICATED. IT IS NOT WARRANTED TO BE REPRESENTATIVE OF SUBSURFACE CONDITIONS AT OTHER LOCATIONS AND TIMES.

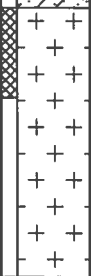
DEPTH IN FEET	SAMPLE NO.	LITHOLOGY	GROUNDWATER	TRENCH T 3		PENETRATION RESISTANCE (BLOWS/FT.)	DRY DENSITY (P.C.F.)	MOISTURE CONTENT (%)
				ELEV. (MSL.) <u>477'</u>	DATE COMPLETED <u>12-01-2006</u>			
				EQUIPMENT <u>JD TRACKHOE</u> BY: <u>T. REIST</u>				
MATERIAL DESCRIPTION								
0				SP	ALLUVIUM Loose to very loose, damp, brown, fine to coarse SAND, with 12-inch thick gravel and cobble lenses up to 10-inches (low cohesion)			
2	T3-1							
4					-Becomes more gravelly with cobble up to 18-inches below 5 feet			
6					-Moderate seepage along west side of trench			
8	T3-2			CL	FRIARS FORMATION(weathered) Very stiff, moist, pale green, Silty CLAYSTONE, weak and fissured			
10					-Slightly more competent below 10 feet			
12					GRANITIC ROCK Highly weathered to moderately weathered, brown, moderately strong to strong GRANITIC ROCK			
					TRENCH TERMINATED AT 12 FEET (Geotechnically logged from surface)			

Figure A-18,
Log of Trench T 3, Page 1 of 1

05254-32-13.GPJ

SAMPLE SYMBOLS		... SAMPLING UNSUCCESSFUL		... STANDARD PENETRATION TEST		... DRIVE SAMPLE (UNDISTURBED)
		... DISTURBED OR BAG SAMPLE		... CHUNK SAMPLE		... WATER TABLE OR SEEPAGE

NOTE: THE LOG OF SUBSURFACE CONDITIONS SHOWN HEREON APPLIES ONLY AT THE SPECIFIC BORING OR TRENCH LOCATION AND AT THE DATE INDICATED. IT IS NOT WARRANTED TO BE REPRESENTATIVE OF SUBSURFACE CONDITIONS AT OTHER LOCATIONS AND TIMES.

DEPTH IN FEET	SAMPLE NO.	LITHOLOGY	GROUNDWATER	TRENCH T 4		PENETRATION RESISTANCE (BLOWS/FT.)	DRY DENSITY (P.C.F.)	MOISTURE CONTENT (%)
				ELEV. (MSL.) <u>481'</u>	DATE COMPLETED <u>12-01-2006</u>			
				EQUIPMENT <u>JD TRACKHOE</u> BY: <u>T. REIST</u>				
MATERIAL DESCRIPTION								
0				GM	ALLUVIUM Loose, damp, dark brown, Sandy GRAVEL with clay and 40 to 60% gravel and cobble up to 20-inches			
2								
4								
6								
8								
			▼		-Slight seepage at contact			
10					GRANITIC ROCK Highly weathered to moderately weathered, green brown, moderately weak to moderately strong GRANITIC ROCK			
TRENCH TERMINATED AT 11 FEET								

Figure A-19,
Log of Trench T 4, Page 1 of 1

05254-32-13.GPJ

SAMPLE SYMBOLS		... SAMPLING UNSUCCESSFUL		... STANDARD PENETRATION TEST		... DRIVE SAMPLE (UNDISTURBED)
		... DISTURBED OR BAG SAMPLE		... CHUNK SAMPLE		... WATER TABLE OR SEEPAGE

NOTE: THE LOG OF SUBSURFACE CONDITIONS SHOWN HEREON APPLIES ONLY AT THE SPECIFIC BORING OR TRENCH LOCATION AND AT THE DATE INDICATED. IT IS NOT WARRANTED TO BE REPRESENTATIVE OF SUBSURFACE CONDITIONS AT OTHER LOCATIONS AND TIMES.



DEPTH IN FEET	SAMPLE NO.	LITHOLOGY	GROUNDWATER	SOIL CLASS (USCS)	TRENCH T 5			PENETRATION RESISTANCE (BLOWS/FT.)	DRY DENSITY (P.C.F.)	MOISTURE CONTENT (%)
					ELEV. (MSL.) <u>491'</u>	DATE COMPLETED <u>12-01-2006</u>	EQUIPMENT <u>JD TRACKHOE</u> BY: <u>T. REIST</u>			
MATERIAL DESCRIPTION										
0	T5-1			CL	ALLUVIUM Very stiff to stiff, moist, dark brown to dark reddish brown, fine to coarse, Sandy CLAY, with some gravel					
2										
4										
6	T5-2			GM	TERRACE DEPOSIT Dense, damp, reddish brown, fine to coarse Sandy GRAVEL, with 40 to 50% gravel and cobble up to 12-inches					
8	T5-3				GRANITIC ROCK Highly weathered, brown, moderately weak GRANITIC ROCK					
TRENCH TERMINATED AT 9 FEET										

Figure A-20,
Log of Trench T 5, Page 1 of 1

05254-32-13.GPJ

SAMPLE SYMBOLS	 ... SAMPLING UNSUCCESSFUL	 ... STANDARD PENETRATION TEST	 ... DRIVE SAMPLE (UNDISTURBED)
	 ... DISTURBED OR BAG SAMPLE	 ... CHUNK SAMPLE	 ... WATER TABLE OR SEEPAGE

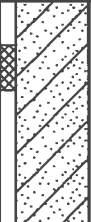
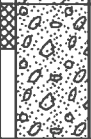
NOTE: THE LOG OF SUBSURFACE CONDITIONS SHOWN HEREON APPLIES ONLY AT THE SPECIFIC BORING OR TRENCH LOCATION AND AT THE DATE INDICATED. IT IS NOT WARRANTED TO BE REPRESENTATIVE OF SUBSURFACE CONDITIONS AT OTHER LOCATIONS AND TIMES.

DEPTH IN FEET	SAMPLE NO.	LITHOLOGY	GROUNDWATER	TRENCH T 6		PENETRATION RESISTANCE (BLOWS/FT.)	DRY DENSITY (P.C.F.)	MOISTURE CONTENT (%)
				SOIL CLASS (USCS)	ELEV. (MSL.) <u>468'</u> DATE COMPLETED <u>12-01-2006</u> EQUIPMENT <u>JD TRACKHOE</u> BY: <u>T. REIST</u>			
MATERIAL DESCRIPTION								
0	T6-1			SC/SM	TOPSOIL Loose, moist, dark brown, Clayey/Silty, fine to coarse SAND, with 10 to 20% gravel and cobble up to 12-inches			
2				CL	Stiff, moist, dark brown, Sandy/Silty CLAY, with 20 to 30% gravel and cobble			
4	T6-2				GRANITIC ROCK Highly weathered to moderately weathered, brown, moderately weak to moderately strong GRANITIC ROCK			
6					PRACTICAL REFUSAL AT 6 FEET			

Figure A-21,
Log of Trench T 6, Page 1 of 1

05254-32-13.GPJ

SAMPLE SYMBOLS	 ... SAMPLING UNSUCCESSFUL	 ... STANDARD PENETRATION TEST	 ... DRIVE SAMPLE (UNDISTURBED)
	 ... DISTURBED OR BAG SAMPLE	 ... CHUNK SAMPLE	 ... WATER TABLE OR SEEPAGE

NOTE: THE LOG OF SUBSURFACE CONDITIONS SHOWN HEREON APPLIES ONLY AT THE SPECIFIC BORING OR TRENCH LOCATION AND AT THE DATE INDICATED. IT IS NOT WARRANTED TO BE REPRESENTATIVE OF SUBSURFACE CONDITIONS AT OTHER LOCATIONS AND TIMES.

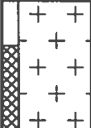

DEPTH IN FEET	SAMPLE NO.	LITHOLOGY	GROUNDWATER	SOIL CLASS (USCS)	TRENCH T 7			PENETRATION RESISTANCE (BLOWS/FT.)	DRY DENSITY (P.C.F.)	MOISTURE CONTENT (%)	
					ELEV. (MSL.) <u>481'</u>	DATE COMPLETED <u>12-01-2006</u>	EQUIPMENT <u>JD TRACKHOE</u> BY: <u>T. REIST</u>				
MATERIAL DESCRIPTION											
0				SM	UNDOCUMENTED FILL Loose, damp, reddish brown, Gravelly SAND, with silt and clay and 30 to 40% gravel and cobble up to 8-inches						
2											
4	T7-1			SM	ALLUVIUM Loose, damp, dark brown, Silty, fine to medium SAND, with trace gravel						
6	T7-2			GC/GM	Medium dense to loose, moist to very moist, Clayey/Sandy GRAVEL, with 40 to 60% gravel and cobble up to 14-inches -Becomes mottled green and brown, cobble size increases to 24-inches below 10 feet						
8											
10											
12					TRENCH TERMINATED AT 12 FEET						

Figure A-22,
Log of Trench T 7, Page 1 of 1

05254-32-13.GPJ

SAMPLE SYMBOLS	 ... SAMPLING UNSUCCESSFUL	 ... STANDARD PENETRATION TEST	 ... DRIVE SAMPLE (UNDISTURBED)
	 ... DISTURBED OR BAG SAMPLE	 ... CHUNK SAMPLE	 ... WATER TABLE OR SEEPAGE

NOTE: THE LOG OF SUBSURFACE CONDITIONS SHOWN HEREON APPLIES ONLY AT THE SPECIFIC BORING OR TRENCH LOCATION AND AT THE DATE INDICATED. IT IS NOT WARRANTED TO BE REPRESENTATIVE OF SUBSURFACE CONDITIONS AT OTHER LOCATIONS AND TIMES.

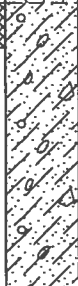





DEPTH IN FEET	SAMPLE NO.	LITHOLOGY	GROUNDWATER	SOIL CLASS (USCS)	TRENCH T 8			PENETRATION RESISTANCE (BLOWS/FT.)	DRY DENSITY (P.C.F.)	MOISTURE CONTENT (%)
					ELEV. (MSL.) <u>476'</u>	DATE COMPLETED <u>12-01-2006</u>	EQUIPMENT <u>JD TRACKHOE</u> BY: <u>T. REIST</u>			
MATERIAL DESCRIPTION										
0	T8-1			SM	ALLUVIUM Loose, damp, dark brown, Gravelly SAND, with 30 to 40% gravel and cobble up to 12-inches					
2										
4										
6				GM	Loose, damp to moist, dark brown, Sandy GRAVEL, with 40 to 60% gravel and cobble up to 12-inches					
8	T8-2				-Becomes clayier and moist below 8 feet with less cobble and gravel					
10										
12			▼	SM	-Slight seepage at contact on west side of trench FRIARS FORMATION Dense, moist, pale green, Silty, fine to coarse SANDSTONE					
TRENCH TERMINATED AT 13 FEET										

Figure A-23,
Log of Trench T 8, Page 1 of 1

05254-32-13.GPJ

SAMPLE SYMBOLS		... SAMPLING UNSUCCESSFUL		... STANDARD PENETRATION TEST		... DRIVE SAMPLE (UNDISTURBED)
		... DISTURBED OR BAG SAMPLE		... CHUNK SAMPLE		... WATER TABLE OR SEEPAGE

NOTE: THE LOG OF SUBSURFACE CONDITIONS SHOWN HEREON APPLIES ONLY AT THE SPECIFIC BORING OR TRENCH LOCATION AND AT THE DATE INDICATED. IT IS NOT WARRANTED TO BE REPRESENTATIVE OF SUBSURFACE CONDITIONS AT OTHER LOCATIONS AND TIMES.

DEPTH IN FEET	SAMPLE NO.	LITHOLOGY	GROUNDWATER	SOIL CLASS (USCS)	TRENCH T 9			PENETRATION RESISTANCE (BLOWS/FT.)	DRY DENSITY (P.C.F.)	MOISTURE CONTENT (%)	
					ELEV. (MSL.) <u>478'</u>	DATE COMPLETED <u>12-01-2006</u>	EQUIPMENT <u>JD TRACKHOE</u> BY: <u>T. REIST</u>				
MATERIAL DESCRIPTION											
0				GM	UNDOCUMENTED FILL Loose, damp, dark brown, Sandy GRAVEL, with 40 to 60% gravel and cobble up to 8-inches						
2											
4				SM	ALLUVIUM Loose, damp, dark brown, Silty, fine to medium SAND, with gravel -Gravel increases with cobbles up to 12-inches -Becomes moist with increase in clay content at 12 feet						
6											
8											
10											
12											
TRENCH TERMINATED AT 12½ FEET											

Figure A-24,
Log of Trench T 9, Page 1 of 1

05254-32-13.GPJ

SAMPLE SYMBOLS		... SAMPLING UNSUCCESSFUL		... STANDARD PENETRATION TEST		... DRIVE SAMPLE (UNDISTURBED)
		... DISTURBED OR BAG SAMPLE		... CHUNK SAMPLE		... WATER TABLE OR SEEPAGE

NOTE: THE LOG OF SUBSURFACE CONDITIONS SHOWN HEREON APPLIES ONLY AT THE SPECIFIC BORING OR TRENCH LOCATION AND AT THE DATE INDICATED. IT IS NOT WARRANTED TO BE REPRESENTATIVE OF SUBSURFACE CONDITIONS AT OTHER LOCATIONS AND TIMES.



DEPTH IN FEET	SAMPLE NO.	LITHOLOGY	GROUNDWATER	SOIL CLASS (USCS)	TRENCH T 10			PENETRATION RESISTANCE (BLOWS/FT.)	DRY DENSITY (P.C.F.)	MOISTURE CONTENT (%)
					ELEV. (MSL.) <u>485'</u>	DATE COMPLETED <u>12-01-2006</u>	EQUIPMENT <u>JD TRACKHOE</u> BY: <u>T. REIST</u>			
MATERIAL DESCRIPTION										
0				CL	TOPSOIL Stiff, moist, dark brown, Sandy CLAY, with some gravel and cobble					
2										
4	T10-1			SM	TERRACE DEPOSIT/FRIARS FORMATION Very dense, damp, reddish brown, fine to coarse Gravelly SAND, with 40 to 50% gravel and cobble up to 20-inches (cemented; very difficult trenching)					
PRACTICAL REFUSAL AT 5 FEET										

Figure A-25,
Log of Trench T 10, Page 1 of 1

05254-32-13.GPJ

SAMPLE SYMBOLS	 ... SAMPLING UNSUCCESSFUL	 ... STANDARD PENETRATION TEST	 ... DRIVE SAMPLE (UNDISTURBED)
	 ... DISTURBED OR BAG SAMPLE	 ... CHUNK SAMPLE	 ... WATER TABLE OR SEEPAGE

NOTE: THE LOG OF SUBSURFACE CONDITIONS SHOWN HEREON APPLIES ONLY AT THE SPECIFIC BORING OR TRENCH LOCATION AND AT THE DATE INDICATED. IT IS NOT WARRANTED TO BE REPRESENTATIVE OF SUBSURFACE CONDITIONS AT OTHER LOCATIONS AND TIMES.

AIR TRACK BORING AT-1
Elevation - 502 Feet (MSL)



GEOCON
INCORPORATED

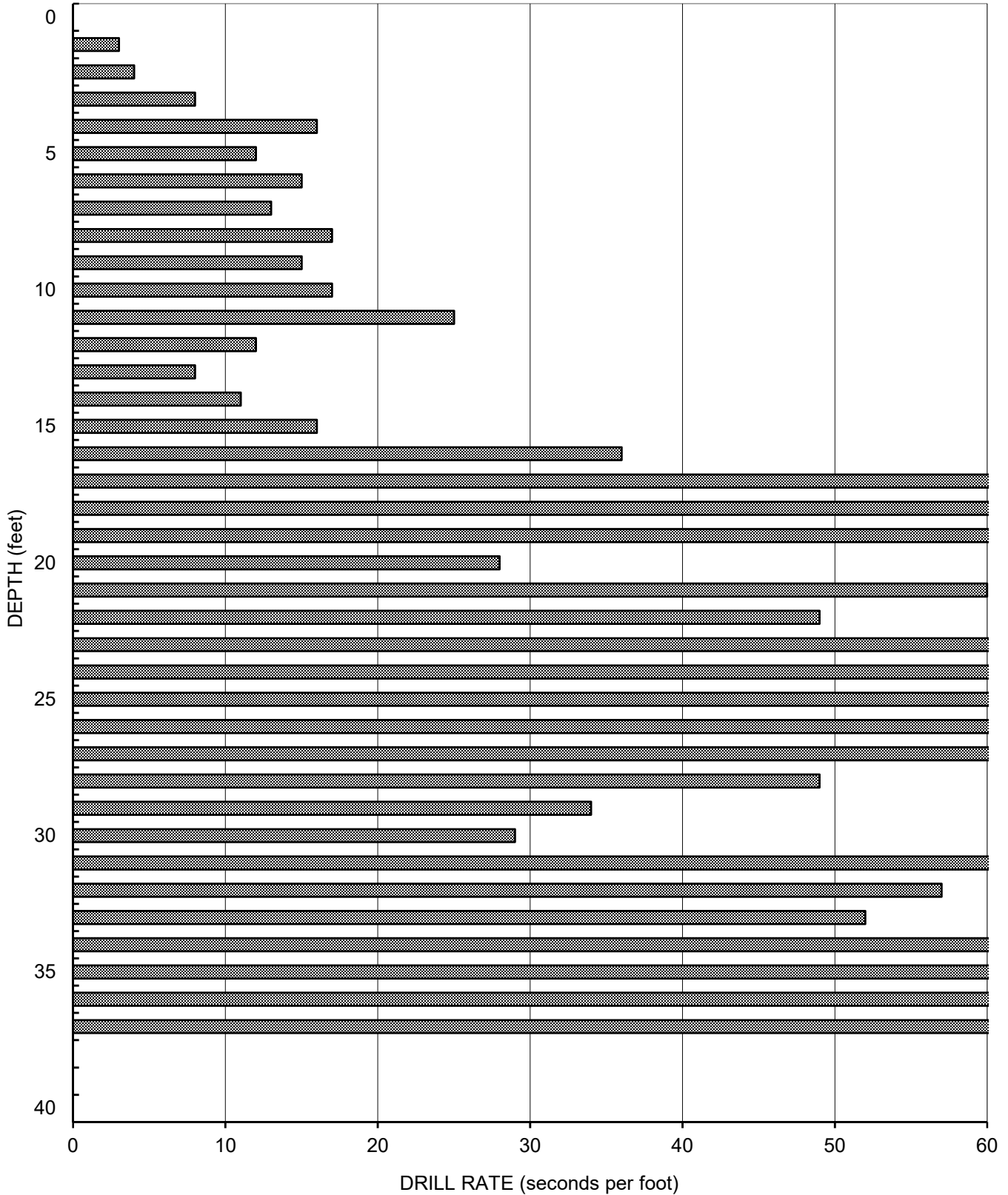

AIR TRACK BORING AT-2
Elevation - 494 Feet (MSL)



GEOCON
INCORPORATED

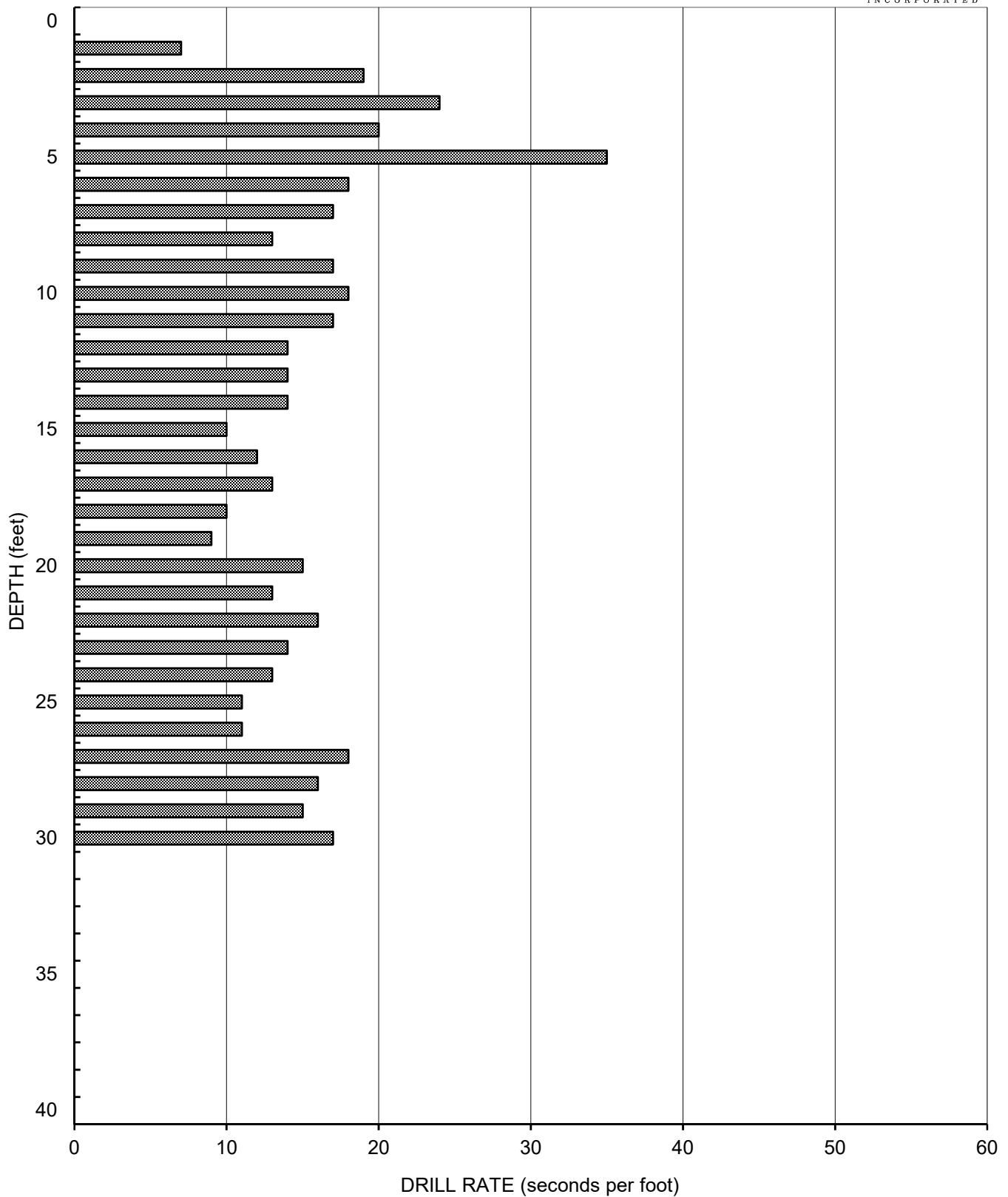

AIR TRACK BORING AT-3
Elevation - 491 Feet (MSL)



GEOCON
INCORPORATED

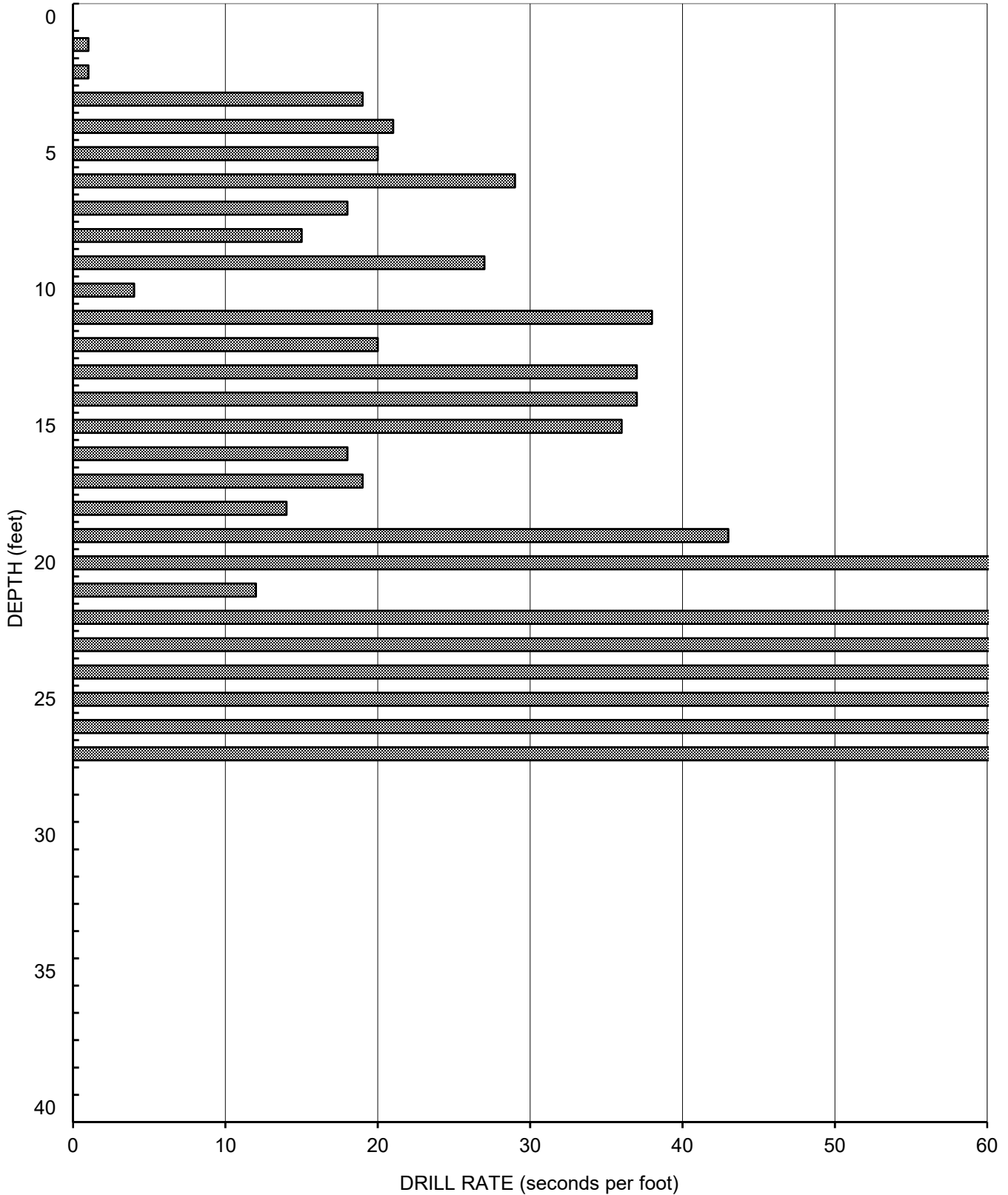

AIR TRACK BORING AT-4
Elevation - 495 Feet (MSL)



GEOCON
INCORPORATED

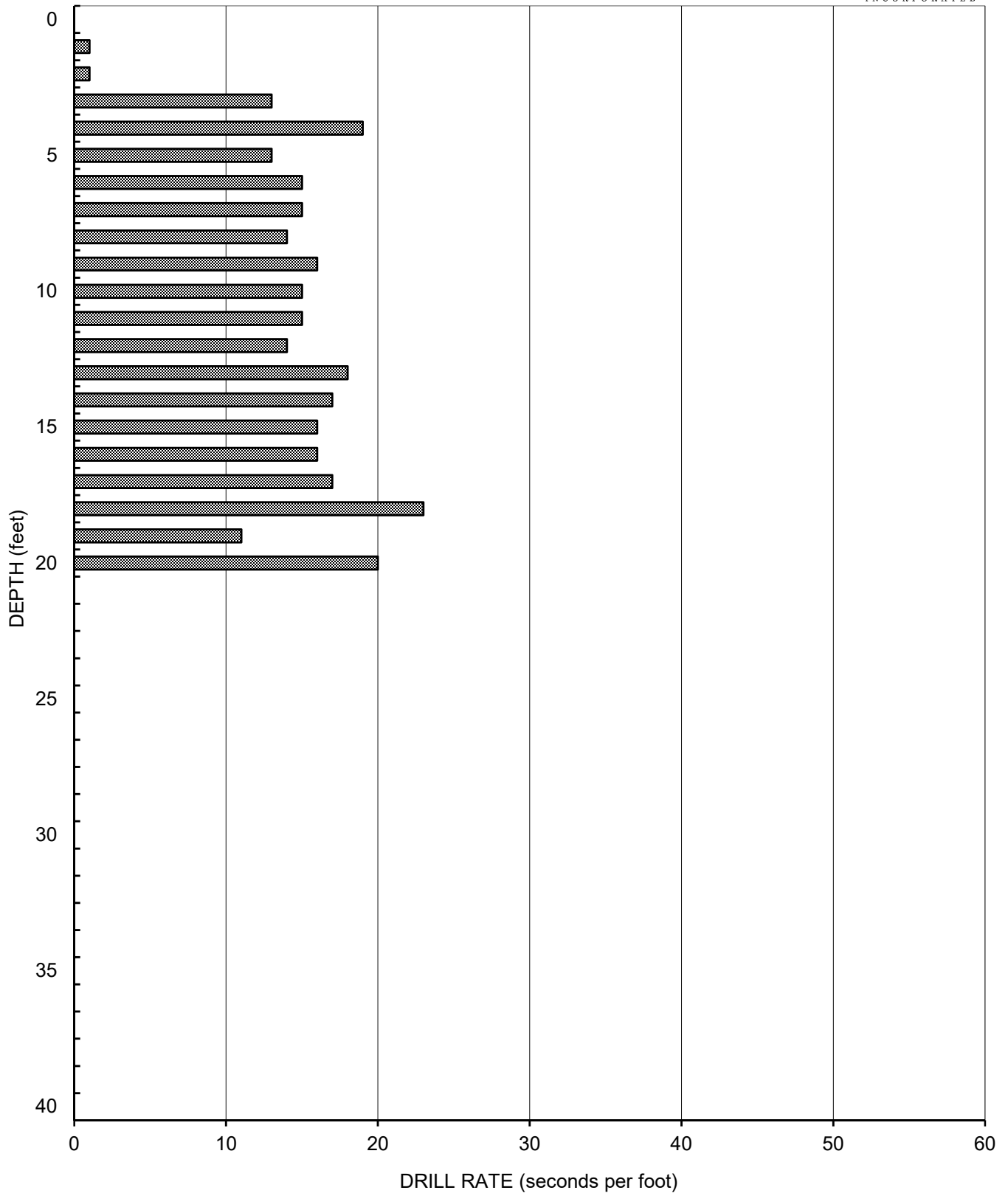

AIR TRACK BORING AT-5
Elevation - 508 Feet (MSL)



GEOCON
INCORPORATED

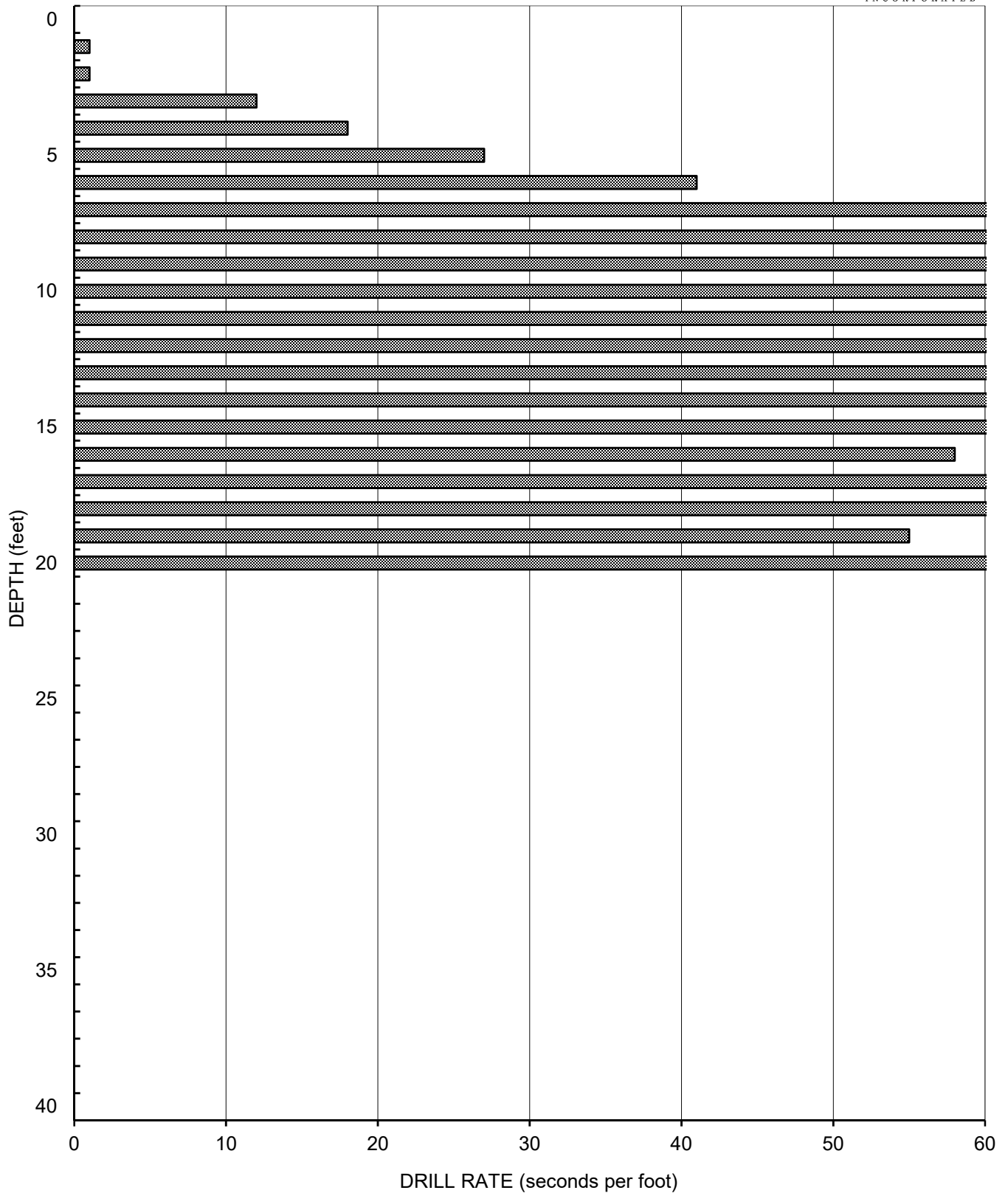

AIR TRACK BORING AT-6
Elevation - 509 Feet (MSL)



GEOCON
INCORPORATED

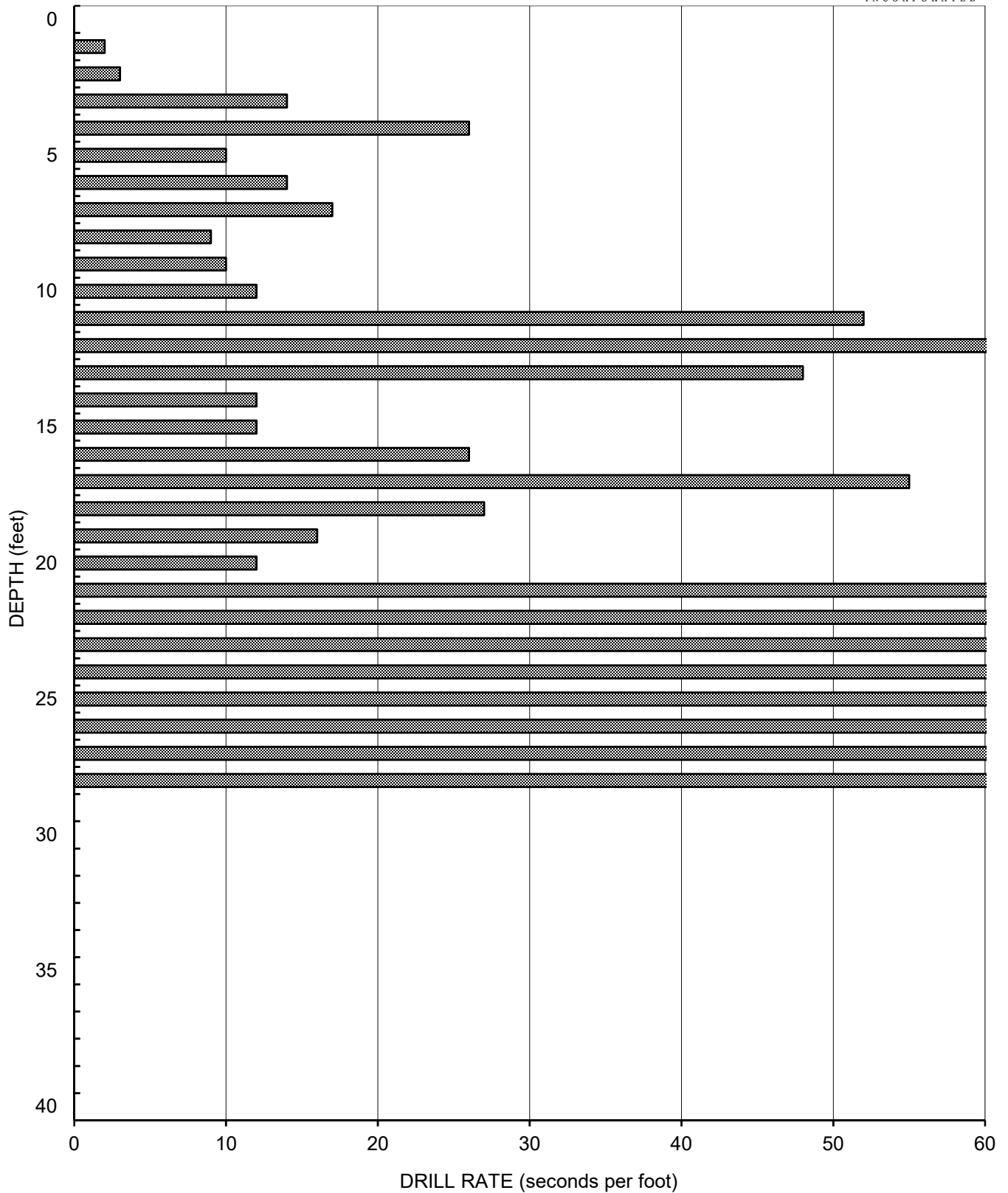

AIR TRACK BORING AT-7
Elevation - 504 Feet (MSL)



GEOCON
INCORPORATED

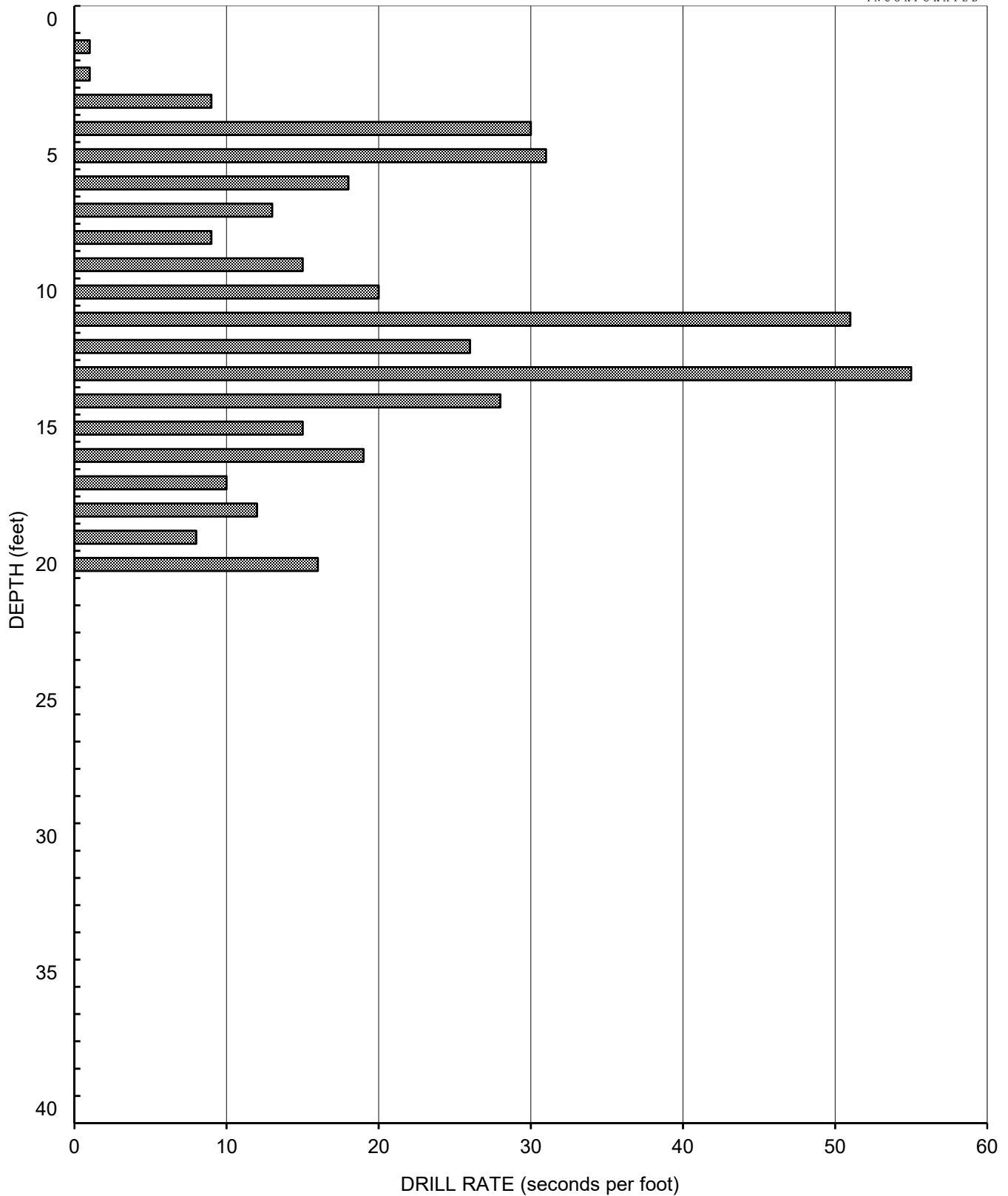

AIR TRACK BORING AT-8
Elevation - 488 Feet (MSL)



GEOCON
INCORPORATED

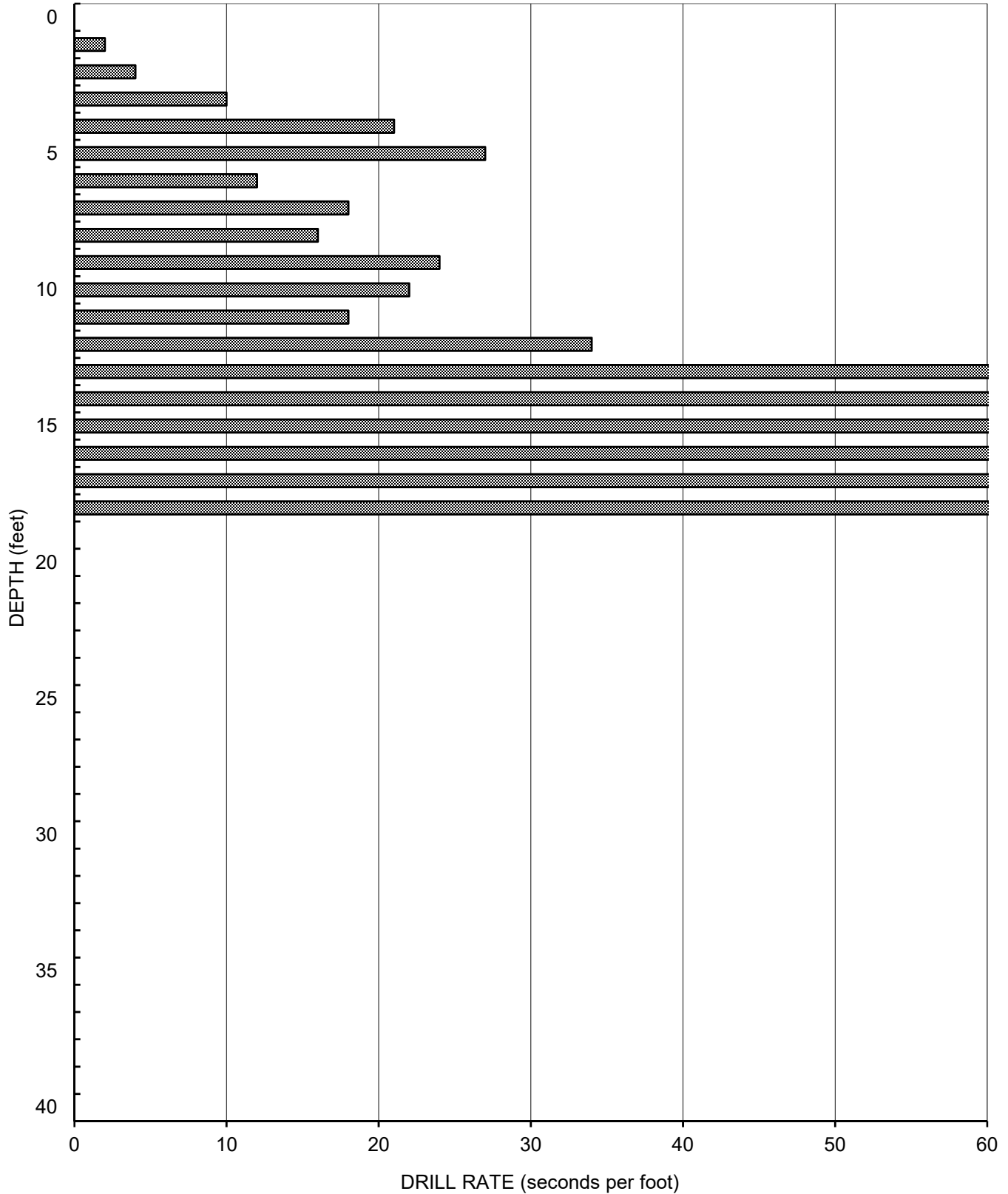

AIR TRACK BORING AT-9
Elevation - 512 Feet (MSL)



GEOCON
INCORPORATED

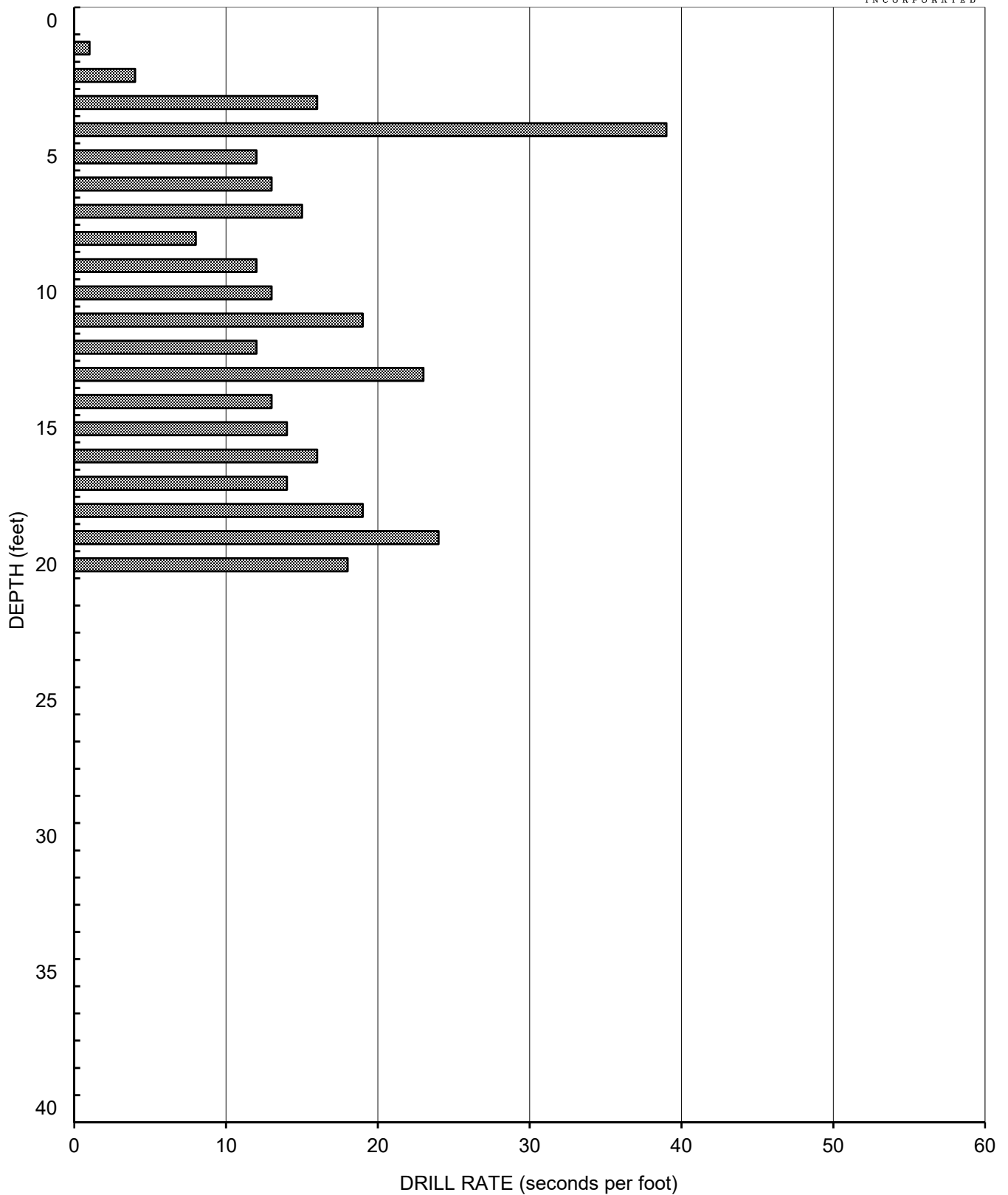

AIR TRACK BORING AT-10
Elevation - 513 Feet (MSL)



GEOCON
INCORPORATED

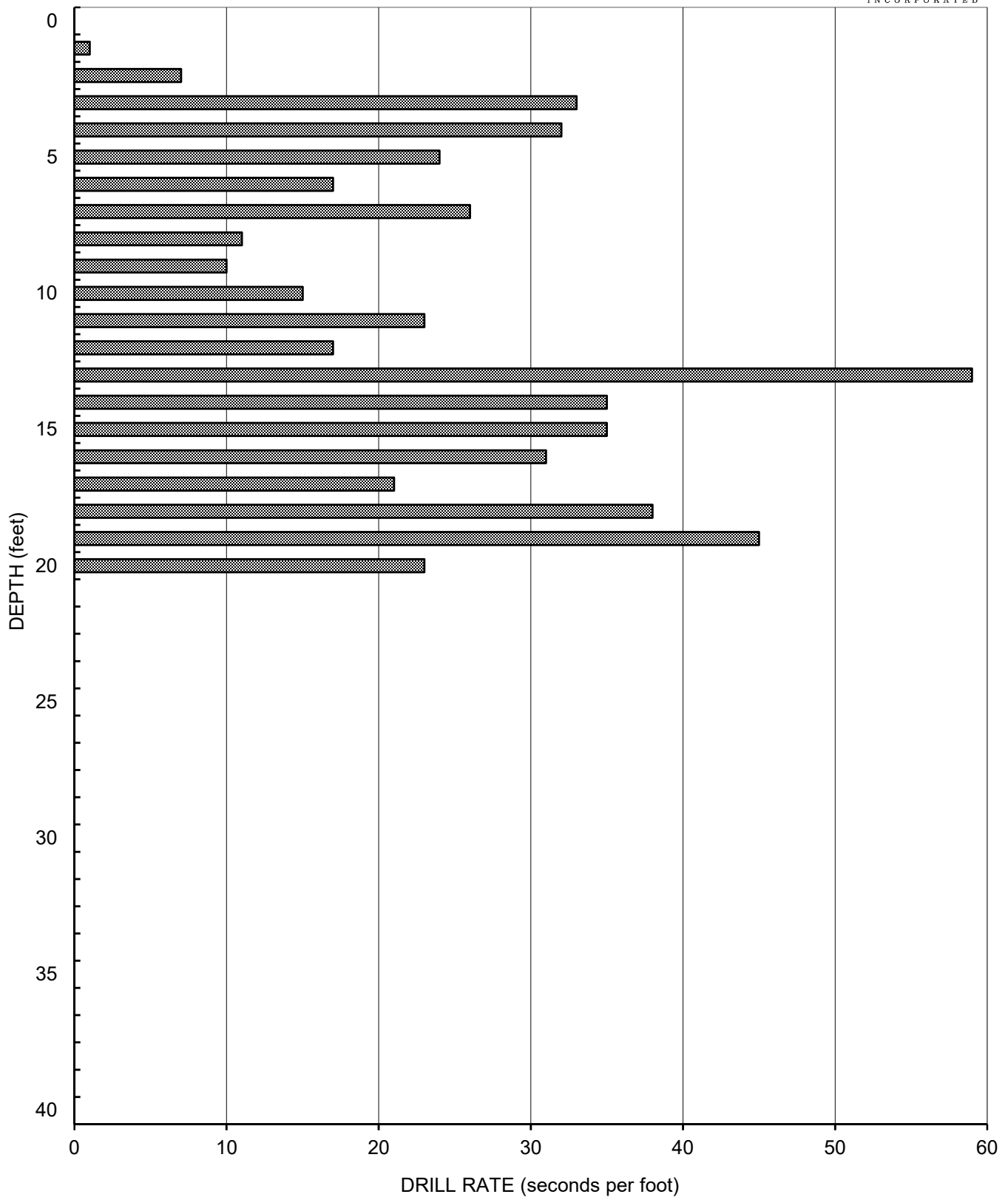

APPENDIX

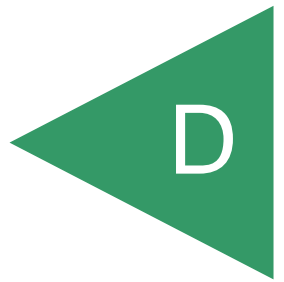

APPENDIX D

SEISMIC REFRACTION SURVEY (2007)

FOR

**FANITA RANCH
FANITA COMMONS, ORCHARD VILLAGE AND VINEYARD VILLAGE
SANTEE, CALIFORNIA**

PROJECT NO. 05254-32-18A

APPENDIX D

FIELD INVESTIGATION

The scope of our services during this study consisted of conducting 8 seismic traverses to examine the rippability characteristics of the underlying bedrock in the areas where significant excavations are proposed. The seismic traverses were performed by Southwest Geophysics, Incorporated utilizing a 24-channel Geometrics StrataView seismograph. Typically, the depth evaluated by a seismic survey is approximately one-third to one-fifth of the traverse length, which generally correlates to approximately 50 to 80 feet for the eight 240-foot traverses. The seismic refraction profiles are on the following pages. A summary of the seismic traverse data is presented in the following table. The locations of the seismic lines are shown on the *Geologic Map*.

Seismic Traverse No.	Average Velocity (foot/second)		Average Depth (feet)		Length of Traverse (feet)	Approximate Maximum Depth Explored (feet)
	V ₁	V ₂	D ₁	D ₂		
S-1	1,550	3,500	4 to 12	>60	240	50 to 60
S-2	2,050	3,900	2 to 10	>60	240	50 to 60
S-3	2,350	5,450	1 to 5	>60	240	50 to 60
S-4	1,800	3,600	5 to 16	>60	240	50 to 60
S-5	1,500	4,550	2 to 5	>60	240	50 to 60
S-6	3,200	4,800	2 to 7	>60	240	50 to 60
S-7	2,050	4,450	2 to 10	>60	240	50 to 60
S-8	2,250	5,000	5 to 8	>60	240	50 to 60

V₁ = Velocity in feet per second of first layer of materials

V₂ = Second layer velocities

D₁ = Depth in feet to base of first layer

D₂ = Depth to base of second layer

NOTE:

For mass grading, materials with velocities of less than 4500 fps are generally rippable with a D10N Caterpillar Tractor equipped with a single shank hydraulic ripper. Velocities of 4500 to 5500 fps indicate marginal ripping and blasting. Velocities greater than 5500 fps generally require pre-blasting. For trenching, materials with velocities less than 3800 fps are generally rippable depending upon the degree of fracturing and the presence or absence of boulders. Velocities between 3800 and 4300 fps generally indicate marginal ripping, and velocities greater than 4300 fps generally indicate non-rippable conditions. The above velocities are based on a Koehring 505.

The reported velocities represent average velocities over the length of each traverse, and should not be used for subsurface interpretation generally greater than 100 feet from a traverse.

Based on this study, it is expected that the majority of the significant excavations along the ridge in Orchard Village will encounter marginally rippable to non-rippable conditions within the Stadium Conglomerate and granitic rock materials. Since the Stadium Conglomerate unconformably overlies granitic rock within the subject site, the contact between these units can occur at variable elevations which can impact project grading when rock is encountered in areas expected to be Stadium Conglomerate assuming the contact is horizontal. It has been our experience that moderately heavy to heavy ripping will be required during grading within the Stadium Conglomerate due to randomly occurring highly cemented zones. Proposed excavations within the granitic rock will likely require very difficult ripping and/or blasting as excavations are extended beyond the rippable weathered mantle. Rock rippability is a function of natural weathering processes which can vary vertically and horizontally over short distances depending on jointing, fracturing and/or mineralogic discontinuities within the bedrock.

Estimates of the anticipated volume of materials generated from proposed excavations should be evaluated based on the information from each seismic traverse and the rippability criteria acceptable to the contractor. Roadway/utility corridor and lot undercutting criteria should also be considered when calculating the volume of material. Proposed cuts in cemented and hard rock areas can be expected to generate oversized fragments (rocks greater than 12 inches in dimension) that will necessitate typical hard rock handling and placement procedures during grading operations.

SL-1

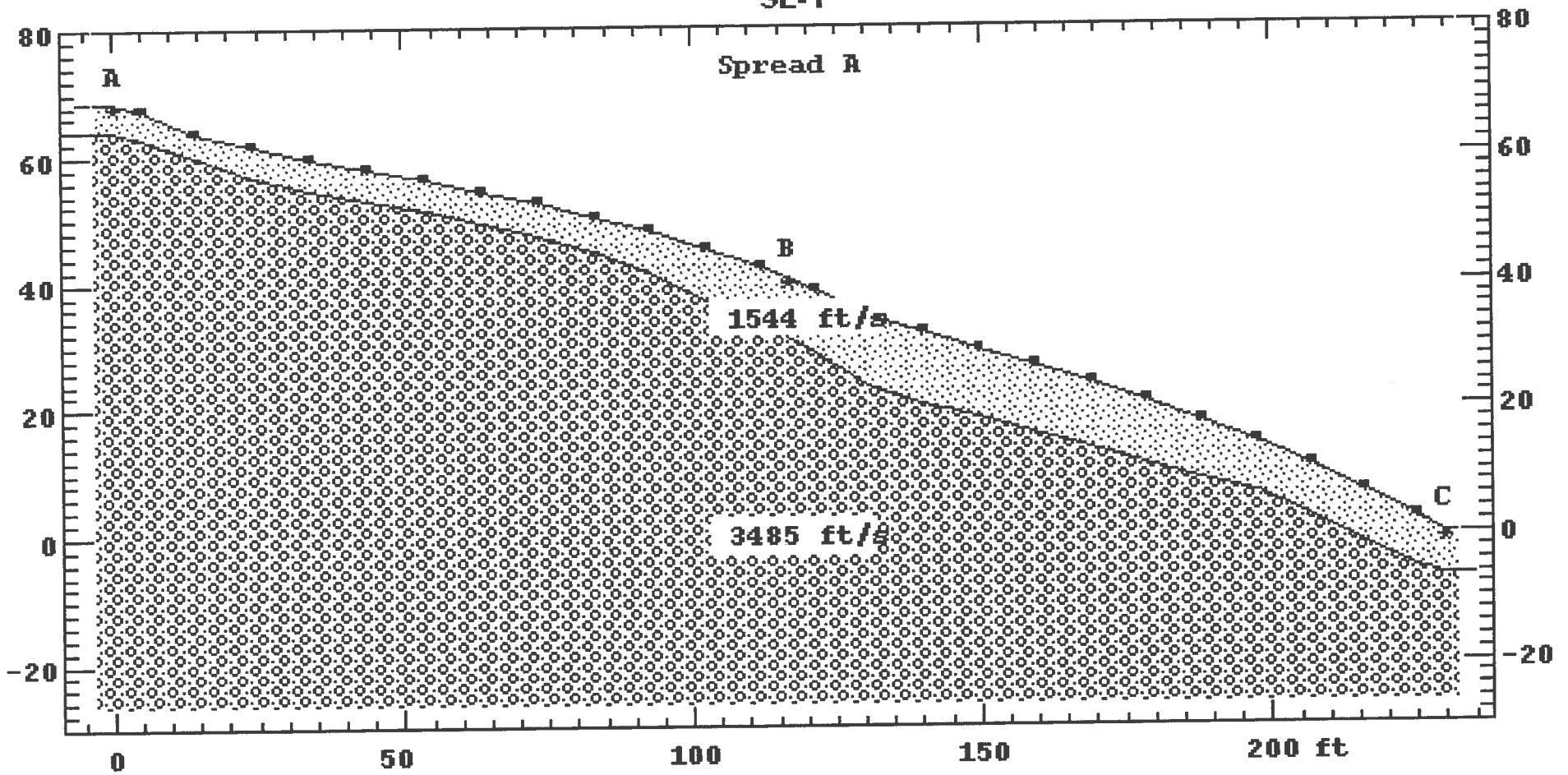

SL-2

Spread A

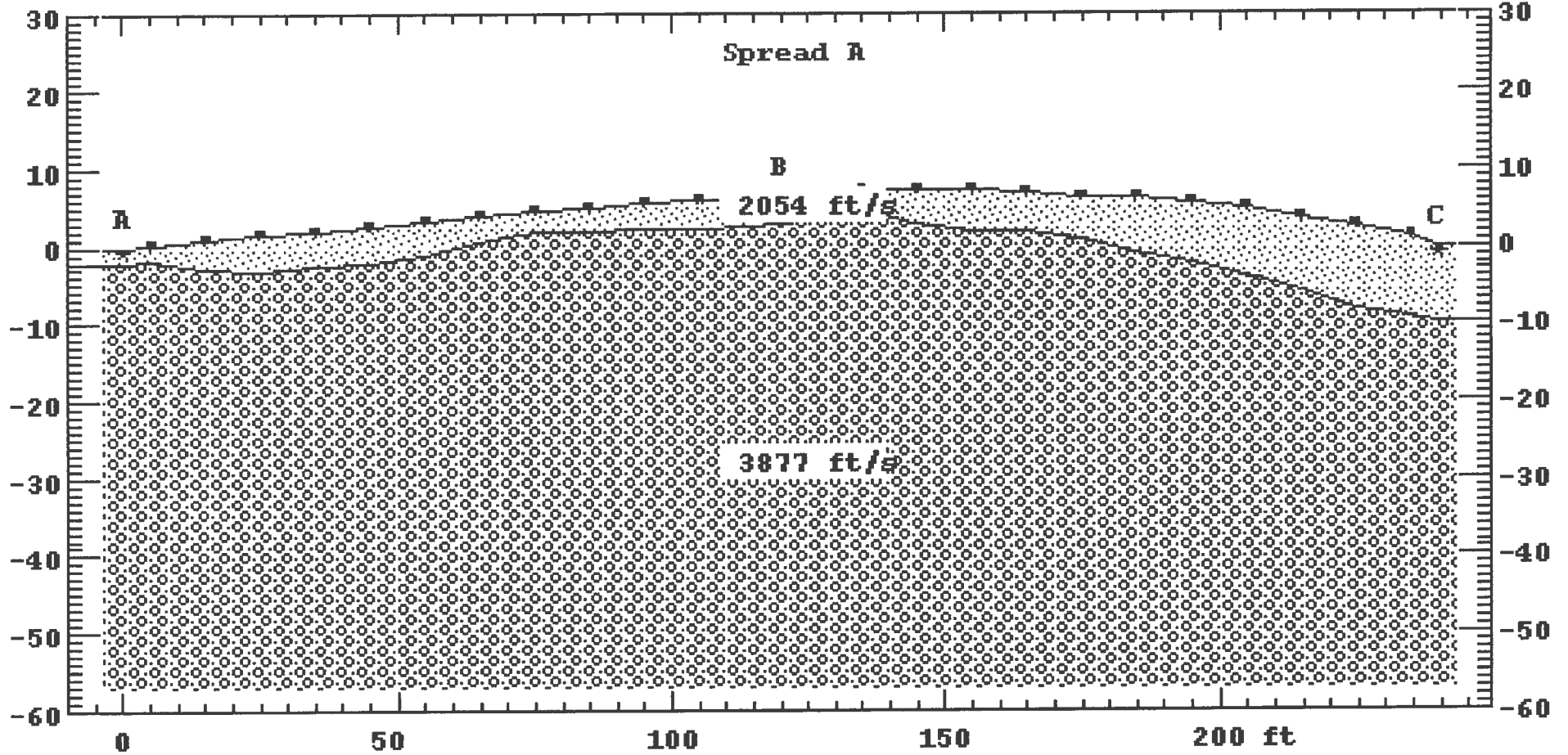

SL-3

Spread A

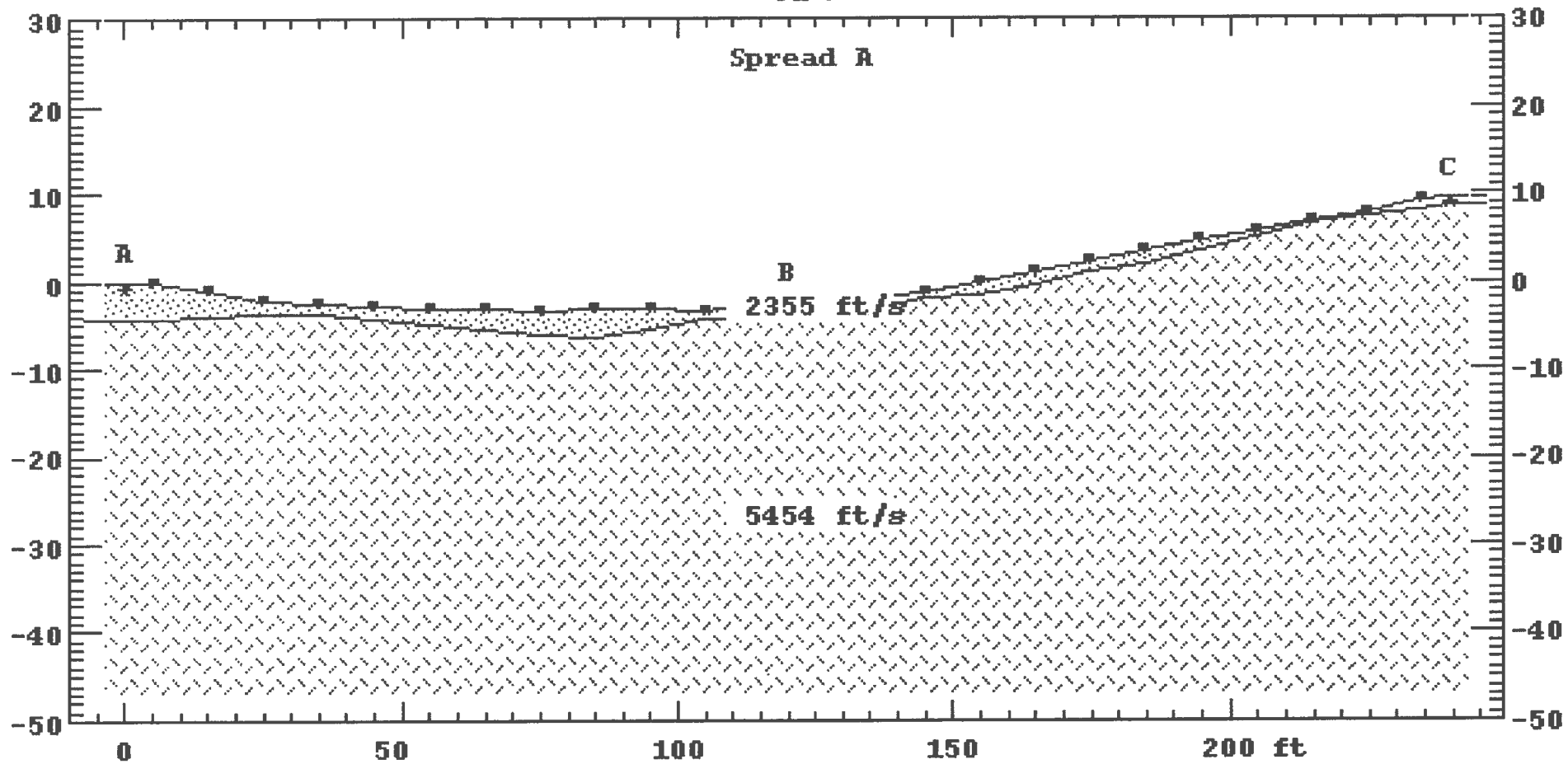

SL-4

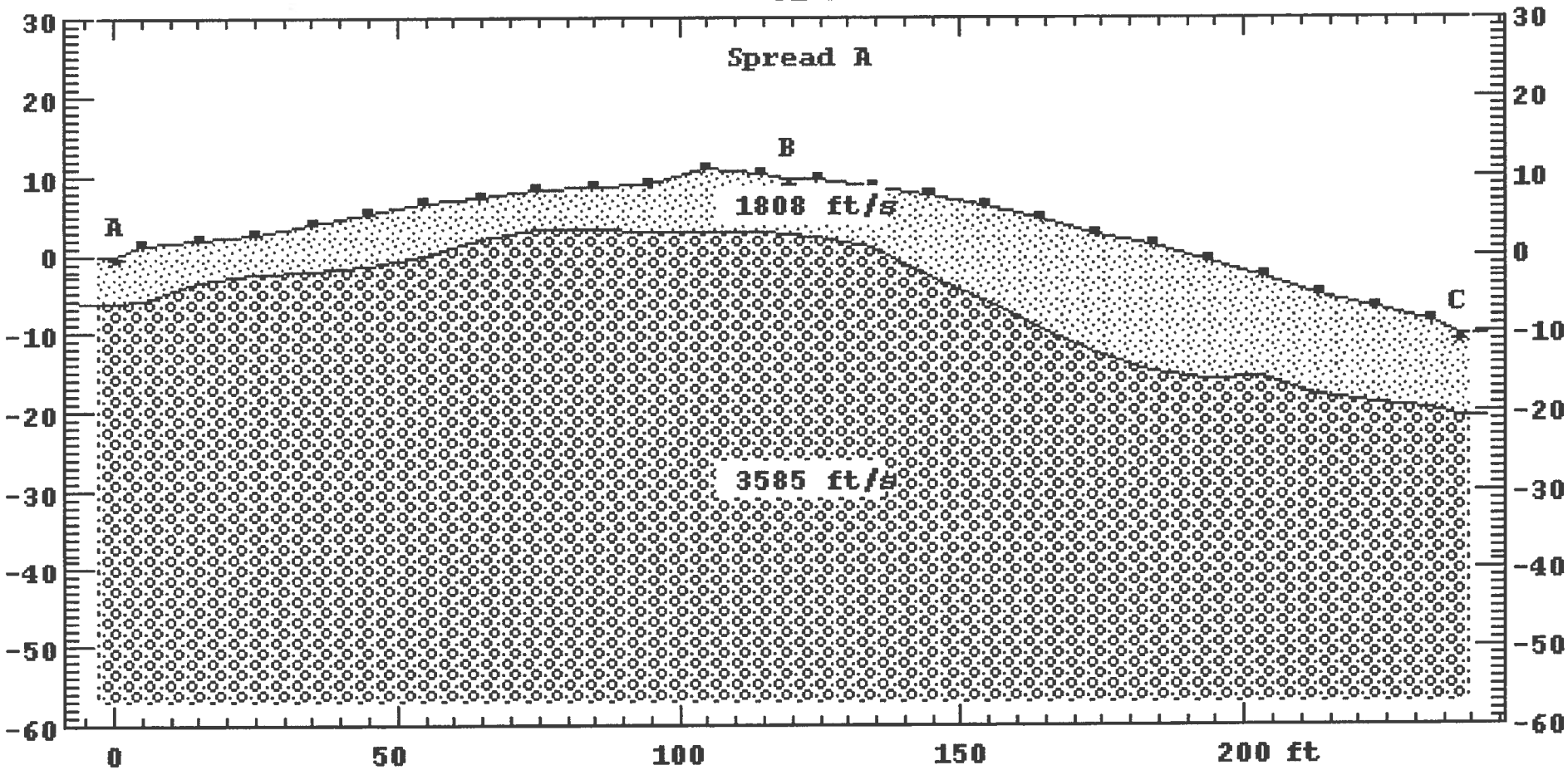

SL-5

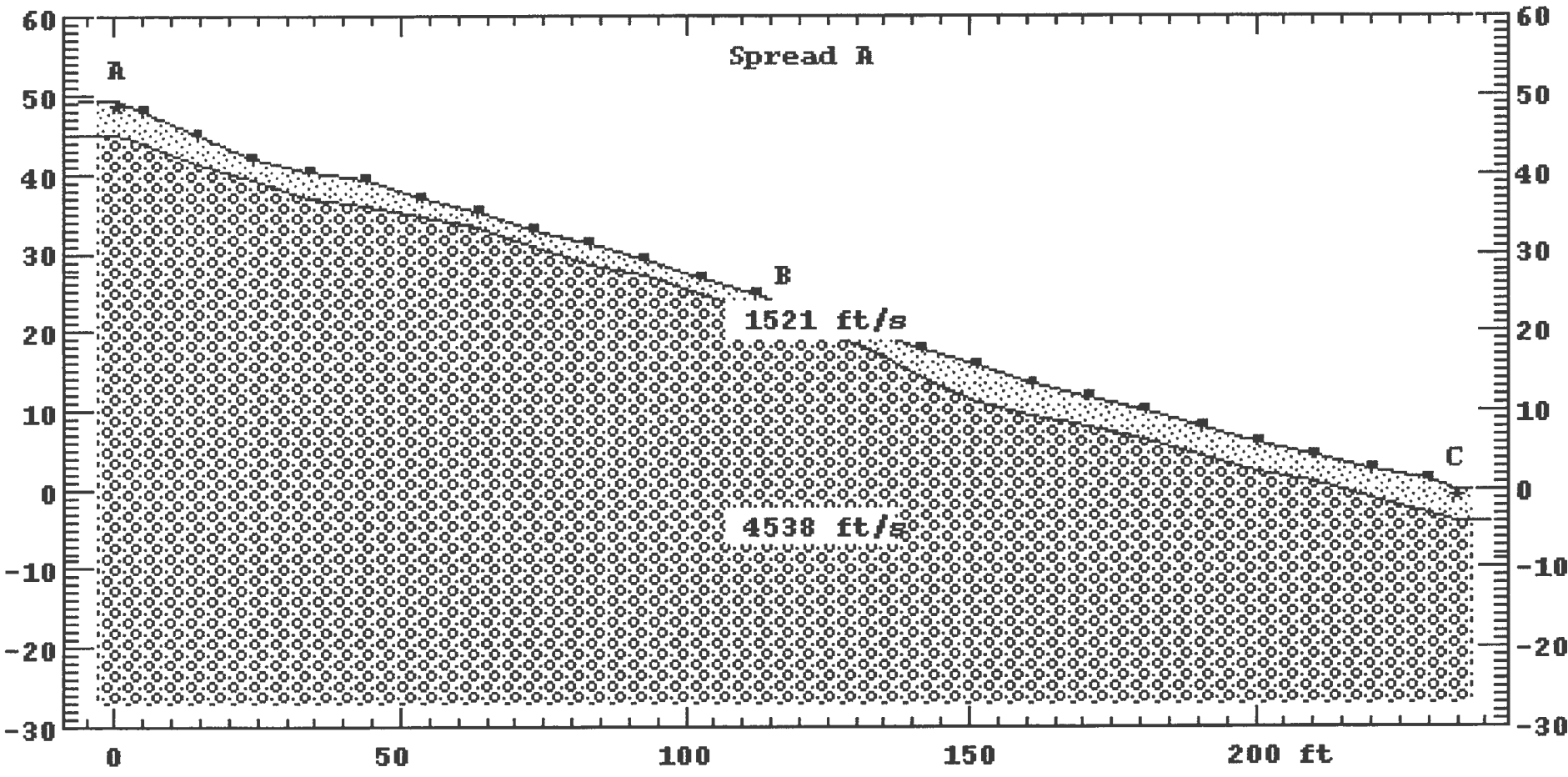

SL-6

Spread A

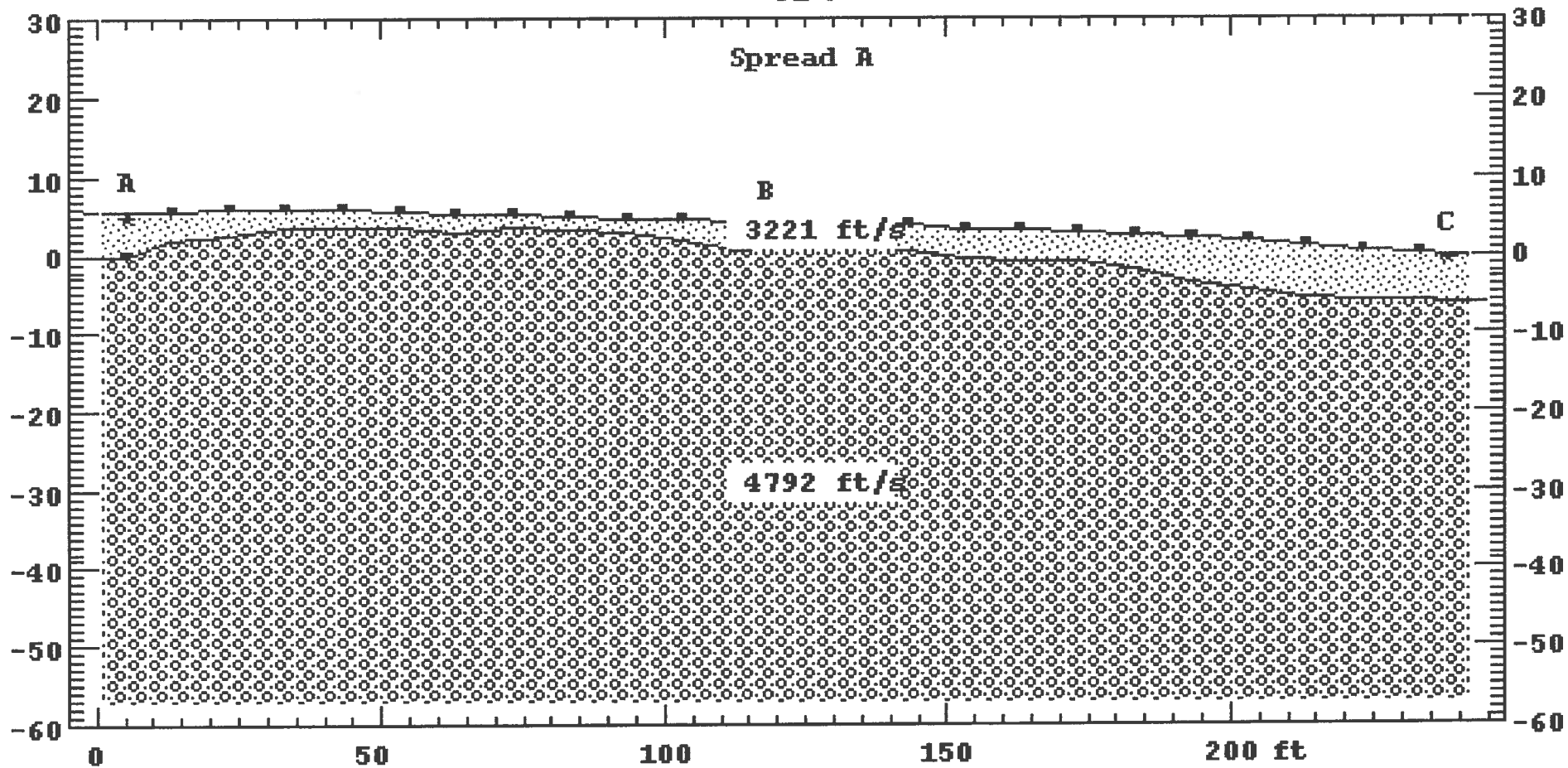

SL-7

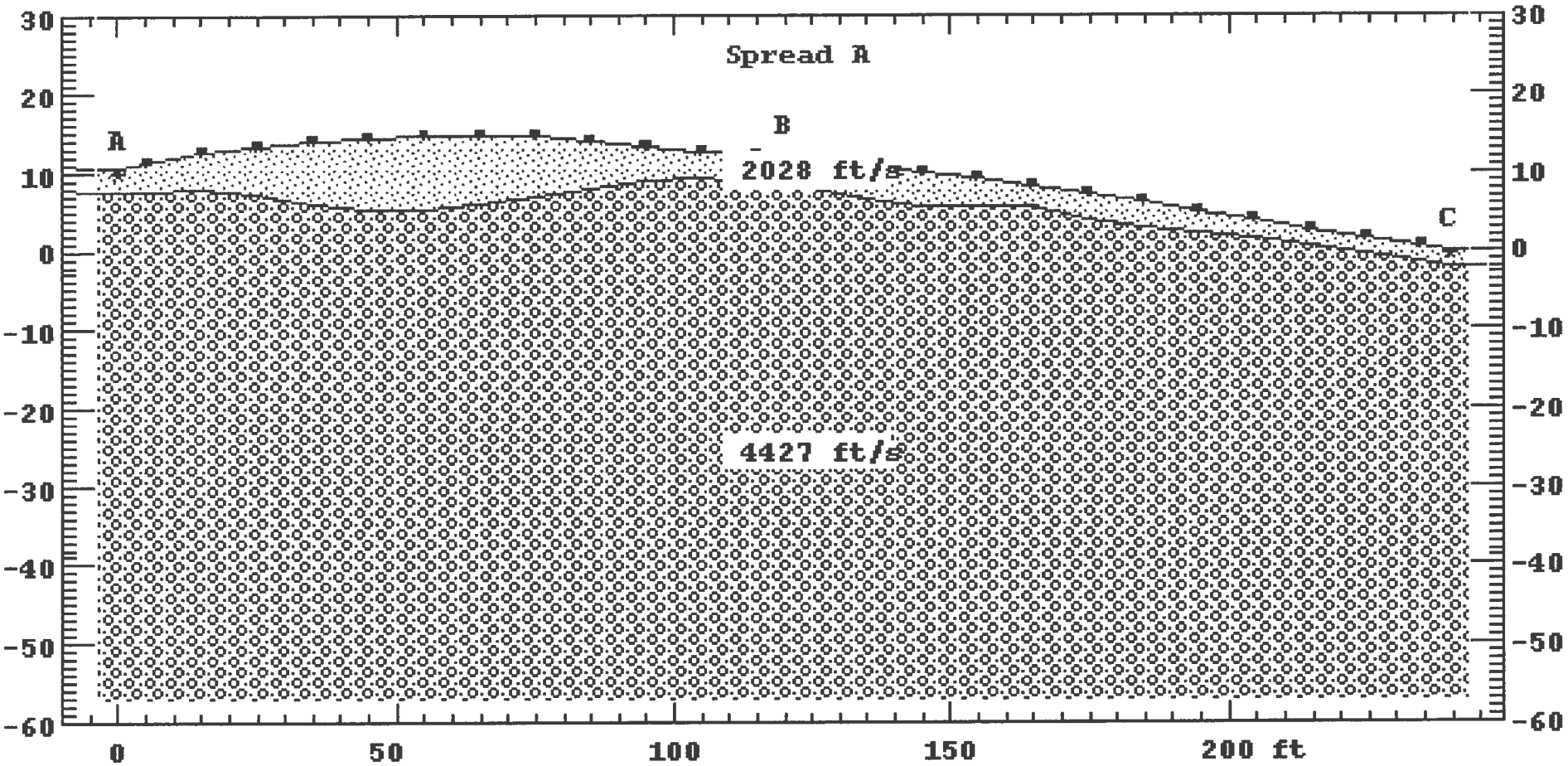

SL-8

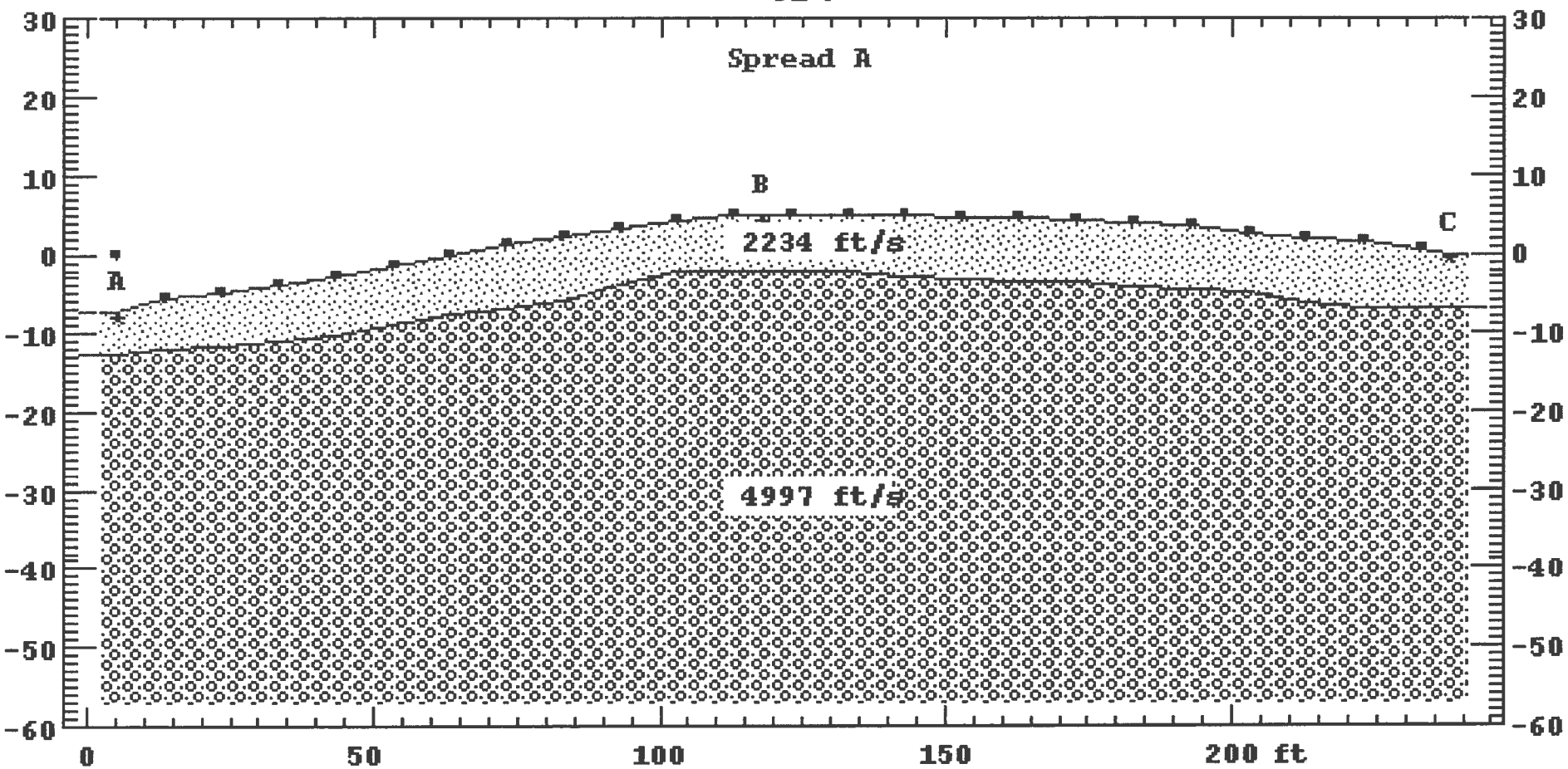

APPENDIX

A solid green triangle pointing to the left, containing the letter 'E' in white.

E

APPENDIX E

LOGS OF TRENCHES (2014)

FOR

**FANITA RANCH
FANITA COMMONS, ORCHARD VILLAGE AND VINEYARD VILLAGE
SANTEE, CALIFORNIA**

PROJECT NO. 05254-32-18A

APPENDIX E
FIELD INVESTIGATION

This field investigation was performed on July 17 and 19, 2014, and consisted of excavating 5 exploratory trenches. Four of the trenches (Trench T-1 through T-4) were excavated within the Stadium Conglomerate Formation and one trench (Trench T-5) was excavated within Cretaceous-age Gabbroic rock (gabbro). This preliminary study was performed to evaluate the rock quality of the cobbles within the Stadium Conglomerate and the western portions of the gabbro. The trench locations are shown on the *Geologic Map*.

DEPTH IN FEET	SAMPLE NO.	LITHOLOGY	GROUNDWATER	TRENCH T 1		PENETRATION RESISTANCE (BLOWS/FT.)	DRY DENSITY (P.C.F.)	MOISTURE CONTENT (%)
				SOIL CLASS (USCS)	ELEV. (MSL.) <u>1070'</u> DATE COMPLETED <u>07-17-2014</u> EQUIPMENT <u>JD 410G Backhoe w/24"bucket</u> BY: <u>M. Embick</u>			
MATERIAL DESCRIPTION								
0	T1-1			GM	TOPSOIL Loose to medium dense, dry, dark brown, Silty GRAVEL and COBBLE, trace clay			
2				GM	STADIUM CONGLOMERATE Very dense, damp, light tan, Cobble CONGLOMERATE, with a Silty, fine to coarse sandy matrix and cobbles up to 12-inch diameter, moderately cemented; difficult excavating			
6				SM/GM	Dense, damp, light tan, Silty, fine to medium SANDSTONE, some gravel and cobble			
10	TRENCH TERMINATED AT 10 FEET Groundwater not encountered Backfilled with trench spoils							

Figure A-1,
Log of Trench T 1, Page 1 of 1

05254-32-11A.GPJ

SAMPLE SYMBOLS	...		
			... DISTURBED OR BAG SAMPLE ... CHUNK SAMPLE ... WATER TABLE OR SEEPAGE

NOTE: THE LOG OF SUBSURFACE CONDITIONS SHOWN HEREON APPLIES ONLY AT THE SPECIFIC BORING OR TRENCH LOCATION AND AT THE DATE INDICATED. IT IS NOT WARRANTED TO BE REPRESENTATIVE OF SUBSURFACE CONDITIONS AT OTHER LOCATIONS AND TIMES.

DEPTH IN FEET	SAMPLE NO.	LITHOLOGY	GROUNDWATER	SOIL CLASS (USCS)	TRENCH T 2			PENETRATION RESISTANCE (BLOWS/FT.)	DRY DENSITY (P.C.F.)	MOISTURE CONTENT (%)
					ELEV. (MSL.) <u>1160'</u>	DATE COMPLETED <u>07-17-2014</u>	EQUIPMENT <u>JD 410G Backhoe w/24"bucket</u> BY: <u>M. Embick</u>			
					MATERIAL DESCRIPTION					
0	T2-1			GM	STADIUM CONGLOMERATE Very dense, damp, light tan, Cobble CONGLOMERATE, with a silty, fine to coarse sandy matrix and cobbles up to 6-inch diameter; moderately cemented; difficult excavating					
2										
4										
6				SM	Dense, damp, light gray, Silty, fine to medium SANDSTONE, little cobble to 6-inches					
8				GM	Very dense, damp, light tan, Cobble CONGLOMERATE, with a silty, fine to coarse sandy matrix and cobbles up to 6-inch diameter; moderately cemented; difficult excavating					
					PRACTICAL REFUSAL AT 9.5 FEET Groundwater not encountered Backfilled with trench spoils					

Figure A-2,
Log of Trench T 2, Page 1 of 1

05254-32-11A.GPJ

SAMPLE SYMBOLS	... SAMPLING UNSUCCESSFUL	... STANDARD PENETRATION TEST	... DRIVE SAMPLE (UNDISTURBED)
		... DISTURBED OR BAG SAMPLE	... CHUNK SAMPLE

NOTE: THE LOG OF SUBSURFACE CONDITIONS SHOWN HEREON APPLIES ONLY AT THE SPECIFIC BORING OR TRENCH LOCATION AND AT THE DATE INDICATED. IT IS NOT WARRANTED TO BE REPRESENTATIVE OF SUBSURFACE CONDITIONS AT OTHER LOCATIONS AND TIMES.

DEPTH IN FEET	SAMPLE NO.	LITHOLOGY	GROUNDWATER	TRENCH T 3		PENETRATION RESISTANCE (BLOWS/FT.)	DRY DENSITY (P.C.F.)	MOISTURE CONTENT (%)
				ELEV. (MSL.) <u>1180'</u>	DATE COMPLETED <u>07-17-2014</u>			
				EQUIPMENT <u>JD 410G Backhoe w/24"bucket</u>		BY: <u>M. Embick</u>		
MATERIAL DESCRIPTION								
0	T3-1			GM	<p>STADIUM CONGLOMERATE Very dense, damp, light tan, Cobble CONGLOMERATE, with a Silty, fine to coarse sandy matrix and cobbles up to 6-inch diameter, moderately cemented; very difficult to excavate</p> <p>-At 5 feet becomes weakly cemented, increasing sandy matrix and cobbles up to 12-inch diameter; becomes less difficult to excavate</p>			
2								
4								
6								
8								
10								
12				SM	Dense, moist, light gray, Silty, fine to medium SANDSTONE, few cobble to 3 inches			
					TRENCH TERMINATED AT 12.5 FEET Groundwater not encountered Backfilled with trench spoils			

Figure A-3,
Log of Trench T 3, Page 1 of 1

05254-32-11A.GPJ

SAMPLE SYMBOLS		... SAMPLING UNSUCCESSFUL		... STANDARD PENETRATION TEST		... DRIVE SAMPLE (UNDISTURBED)
		... DISTURBED OR BAG SAMPLE		... CHUNK SAMPLE		... WATER TABLE OR SEEPAGE

NOTE: THE LOG OF SUBSURFACE CONDITIONS SHOWN HEREON APPLIES ONLY AT THE SPECIFIC BORING OR TRENCH LOCATION AND AT THE DATE INDICATED. IT IS NOT WARRANTED TO BE REPRESENTATIVE OF SUBSURFACE CONDITIONS AT OTHER LOCATIONS AND TIMES.

DEPTH IN FEET	SAMPLE NO.	LITHOLOGY	GROUNDWATER	TRENCH T 4		PENETRATION RESISTANCE (BLOWS/FT.)	DRY DENSITY (P.C.F.)	MOISTURE CONTENT (%)
				ELEV. (MSL.) <u>1160'</u>	DATE COMPLETED <u>07-17-2014</u>			
				EQUIPMENT <u>JD 410G Backhoe w/24"bucket</u>		BY: <u>M. Embick</u>		
MATERIAL DESCRIPTION								
0	T4-1			GM	<p>STADIUM CONGLOMERATE Dense to very dense, damp, light tan, Cobble CONGLOMERATE, with a Silty, fine to coarse sandy matrix and cobbles up to 8-inch diameter, moderately cemented; moderately difficult to excavate</p>			
2								
4								
6								
8					-At 6.5 feet, increasing sand matrix, decreasing cobble portion			
10				SM	Dense, damp, very light gray, Silty, fine to medium SANDSTONE, lightly to moderately cemented			
12								
14					TRENCH TERMINATED AT 14 FEET Groundwater not encountered Backfilled with trench spoils			

Figure A-4,
Log of Trench T 4, Page 1 of 1

05254-32-11A.GPJ

SAMPLE SYMBOLS	□ ... SAMPLING UNSUCCESSFUL	□ ... STANDARD PENETRATION TEST	■ ... DRIVE SAMPLE (UNDISTURBED)
		⊗ ... DISTURBED OR BAG SAMPLE	▣ ... CHUNK SAMPLE

NOTE: THE LOG OF SUBSURFACE CONDITIONS SHOWN HEREON APPLIES ONLY AT THE SPECIFIC BORING OR TRENCH LOCATION AND AT THE DATE INDICATED. IT IS NOT WARRANTED TO BE REPRESENTATIVE OF SUBSURFACE CONDITIONS AT OTHER LOCATIONS AND TIMES.









DEPTH IN FEET	SAMPLE NO.	LITHOLOGY	GROUNDWATER	SOIL CLASS (USCS)	TRENCH T 5			PENETRATION RESISTANCE (BLOWS/FT.)	DRY DENSITY (P.C.F.)	MOISTURE CONTENT (%)
					ELEV. (MSL.) <u>990'</u>	DATE COMPLETED <u>07-17-2014</u>	EQUIPMENT <u>JD 410G Backhoe w/24"bucket</u> BY: <u>M. Embick</u>			
					MATERIAL DESCRIPTION					
0				SM	TOPSOIL Medium dense, dry, brown, Silty, fine to medium SAND, trace clay					
2	T5-1				GABBROIC ROCK Weak, highly weathered, brownish red, GRANITIC ROCK; excavates to silty, fine to coarse sand					
4	T5-2				Moderately weak, moderately to highly weathered, gray, GRANITIC ROCK; excavates to silty, fine to coarse sand -Difficult to excavate at 3 feet					
6	TRENCH TERMINATED AT 6 FEET Groundwater not encountered Backfilled with trench spoils									

Figure A-5,
Log of Trench T 5, Page 1 of 1

05254-32-11A.GPJ

SAMPLE SYMBOLS	 ... SAMPLING UNSUCCESSFUL	 ... STANDARD PENETRATION TEST	 ... DRIVE SAMPLE (UNDISTURBED)
	 ... DISTURBED OR BAG SAMPLE	 ... CHUNK SAMPLE	 ... WATER TABLE OR SEEPAGE

NOTE: THE LOG OF SUBSURFACE CONDITIONS SHOWN HEREON APPLIES ONLY AT THE SPECIFIC BORING OR TRENCH LOCATION AND AT THE DATE INDICATED. IT IS NOT WARRANTED TO BE REPRESENTATIVE OF SUBSURFACE CONDITIONS AT OTHER LOCATIONS AND TIMES.

APPENDIX



APPENDIX F

LABORATORY TESTING (1997)

FOR

**FANITA RANCH
FANITA COMMONS, ORCHARD VILLAGE AND VINEYARD VILLAGE
SANTEE, CALIFORNIA**

PROJECT NO. 05254-32-18A

APPENDIX F

LABORATORY TESTING

Laboratory tests were performed in general accordance with the test methods of the American Society for Testing and Materials (ASTM) or other suggested procedures. Selected, relatively undisturbed drive samples and bulk samples were tested for their in-place dry density and moisture content, maximum dry density and optimum moisture content, expansion index, direct shear strength, pH/resistivity, and plasticity index.

The results of our laboratory tests are presented as follows on Tables F-I through F-V. The in-place density and moisture characteristics are presented on the logs of the exploratory borings and trenches.

**TABLE F-I
SUMMARY OF LABORATORY MAXIMUM DRY DENSITY
AND OPTIMUM MOISTURE CONTENT TEST RESULTS**

Sample No.	Description	Maximum Dry Density (pcf)	Optimum Moisture Content (% dry wt.)
B3-7	Brown, Sandy CLAY	108.6	18.8
B3-16	Light green, Silty, fine SAND	114.2	15.4
B7-2	Light brown, Silty, fine SAND	106.1	18.8
B11-2	Medium brown, Silty CLAY	113.9	16.5
B16-2	Light gray, Silty, fine SAND	114.2	15.3
B16-10	Medium green, Clayey, Silty SAND	112.4	16.8
B20-1	Light brown, Gravelly, Silty SAND with cobbles	122.8	12.5
B21-5	Light gray, Silty, fine SAND	123.3	11.4
B26-2	Light brown, Clayey, fine to medium SAND	119.9	13.2
B27-1	Light brown, Gravelly CLAY with cobbles	123.0	11.0
B29-4	Light green-gray, Silty, fine SAND	102.5	22.7
B29-4	Light green-gray, Silty, fine SAND	102.5	22.7

**TABLE F-I (CONTINUED)
SUMMARY OF LABORATORY MAXIMUM DRY DENSITY
AND OPTIMUM MOISTURE CONTENT TEST RESULT**

Sample No.	Description	Maximum Dry Density (pcf)	Optimum Moisture Content (% dry wt.)
B34-1	Light brown, Gravelly, Clayey SAND with cobbles	130.1	9.1
B37-1	Light green-gray, Clayey SAND	116.1	15.4
B43-1	Light brown, Gravelly, Clayey SAND with cobbles	128.7	10.6
B45-5	Dark green, Silty CLAY	112.0	17.8
B50-7	Light grey, Silty SAND	122.8	12.0
B51-2	Grey-green, Gravelly, Clayey, Silty SAND	121.5	13.8
B55-3	Brown, Sandy, Silty CLAY	113.8	15.3

**TABLE F-II
SUMMARY OF LABORATORY EXPANSION INDEX TEST RESULTS**

Sample No.	Moisture Content		Dry Density (pcf)	Expansion Index
	Before Test (%)	After Test (%)		
B27-1	11.0	27.7	107.0	57
B28-2	11.6	28.4	103.4	73
B34-1	8.2	23.0	117.0	37
B35-6	14.4	40.6	94.2	115
B45-9	10.9	34.3	104.8	76
B51-2	10.8	28.3	108.2	57

**TABLE F-III
SUMMARY OF DIRECT SHEAR TEST RESULTS**

Sample No.	Dry Density (pcf)	Moisture Content (%)	Unit Cohesion (psf)	Angle of Shear Resistance (degrees)
B3-7*	98.4	18.1	525	29
B3-8	106.3	21.2	390	37
B3-14	116.5	12.6	420	43
B3-16*	103.3	15.0	800	32
B5-8**	89.3	35.0	240	7
B8-3	101.1	22.2	700	19
B8-10	105.7	21.9	2200	21
B11-2*	102.6	16.6	1000	7
B11-6	97.0	26.9	600	44
B11-11	101.0	25.9	270	38
B16-2*	103.3	14.9	425	30
B16-9	106.4	21.7	1375	20
B16-10*	101.5	16.4	940	30
B19-3	104.1	23.2	450	37
B19-7	104.0	22.8	375	28
B20-1*	110.4	12.8	900	25
B21-5*	111.0	11.3	950	36
B24-2	106.9	20.2	1000	36
B26-1	118.9	13.6	1350	39
B26-2*	107.8	13.3	900	38
B26-5	118.1	15.9	1940	33
B27-1*	109.9	11.8	450	34
B29-4*	93.9	20.8	975	32
B29-8	121.7	14.5	1500	45
B29-12	117.1	17.4	900	45
B34-1*	117.1	9.3	775	27
B35-3	111.5	17.4	880	41
B35-4	101.3	25.0	600	24
B37-1*	104.8	15.2	400	30
B43-1*	115.4	10.8	890	30
B43-2	108.8	20.0	760	30
B43-4	127.4	12.3	700	45
B44-1	99.3	24.5	650	37

**TABLE F-III (CONTINUED)
SUMMARY OF DIRECT SHEAR TEST RESULTS**

Sample No.	Dry Density (pcf)	Moisture Content (%)	Unit Cohesion (psf)	Angle of Shear Resistance (degrees)
B44-5	117.2	15.5	1400	40
B45-4	113.3	19.0	1500	30
B45-5*	101.1	17.4	1070	30
B50-2	101.5	24.4	1000	30
B50-6	127.2	11.8	1600	45
B50-7*	110.7	11.8	750	36
B51-2*	109.0	14.2	1050	23
B52-1	119.1	14.3	350	45
B55-2	110.9	17.3	590	34
B55-3*	101.9	15.9	.385	31
B55-4	115.4	20.2	790	44
B60-1**	83.5	38.8	300	14
B68-6	105.6	22.2	800	34
B68-10**	87.9	35.5	100	12
B75-1**	106.4	21.7	695	18
B75-3	124.1	13.0	1340	29

*Sample remolded to approximately 90 percent of maximum dry density at near optimum moisture content.

**Residual shear.

**TABLE F-IV
SUMMARY OF LABORATORY POTENTIAL OF
HYDROGEN (PH) AND RESISTIVITY TEST RESULTS**

Sample No.	pH	Resistivity (ohm centimeters)
B3-3	9.9	704
B55-5	8.3	484

**TABLE F-V
SUMMARY OF LABORATORY PLASTICITY INDEX TEST RESULTS**

Sample No.	Description	Liquid Limit (LL)	Plastic Limit (PL)	Plasticity Index (PI)	Unified Soil Classification (Group Symbol)
B7-7	Olive-tan, Silty CLAY, with trace of sand	70	28	42	CH
B11-2	Brown, fine to medium Sandy CLAY	78	22	56	CH

APPENDIX



APPENDIX G

LABORATORY TESTING (2007)

FOR

**FANITA RANCH
FANITA COMMONS, ORCHARD VILLAGE AND VINEYARD VILLAGE
SANTEE, CALIFORNIA**

PROJECT NO. 05254-32-18A

APPENDIX G

LABORATORY TESTING

Laboratory tests were conducted during the Lake study in 2006 (reported in 2007) and were performed in accordance with generally accepted test methods of the American Society for Testing and Materials (ASTM) or other suggested procedures. Selected soil samples were tested for their in-place dry density and moisture content, direct shear and triaxial shear strength, maximum dry density and optimum moisture content, water-soluble sulfate, hydraulic conductivity, gradation, and consolidation.

The results of our laboratory tests are presented as follows on Tables G-I through G-IV and Figures G-1 through G-12. The in-place dry density and moisture content results are indicated on the exploratory boring logs.

**TABLE G-I
SUMMARY OF DIRECT SHEAR TEST RESULTS
ASTM 3080-04 AND D 4767-04**

Sample No.	Dry Density (pcf)	Moisture Content (%)	Unit Cohesion (psf)	Angle of Shear Resistance (degrees)
B2-6	81.4	39.9	305	15
B3-2	91.4	30.8	740	24
B3-6	93.2	29.0	570	27
B3-8	91.7	30.4	50	25
B4-5	93.0	29.4	200	38
B4-8	97.5	26.7	290	18
B5-3	100.4	21.7	0	45
*B9-5	93.7	20.7	330	28
B9-7	93.3	29.0	550	30
*B10-1	119.0	9.0	290	34
*B11-1	115.4	10.0	200	35
*B11-2	112.6	11.8	120	42
*T7-2	117.7	9.7	270	30
Triaxial Shear Strength – CU Test				
B5-5	85.7	33.2	170	21
*B9-5	92.8	19.5	170	31
*B11-2	113.9	11.5	500	33

*Samples remolded to 90 percent of the maximum dry density at near optimum moisture content.

**TABLE G-II
SUMMARY OF LABORATORY MAXIMUM DRY DENSITY
AND OPTIMUM MOISTURE CONTENT TEST RESULTS
ASTM D 1557-02**

Sample No.	Description	Maximum Dry Density (pcf)	Optimum Moisture Content (% dry wt.)
B9-5	Light Green, Clayey SILT	102.9	19.8
B10-1	Dark Brown Clayey SAND	131.3	9.7
B11-1	Red Brown Gravelly SAND	128.1	10.1
B11-2	Dark Yellow Brown Slightly Silty SAND	125.3	11.6
T7-2	Dark Red Brown, Sandy GRAVEL	132.0	8.7

**TABLE G-III
SUMMARY OF LABORATORY WATER-SOLUBLE SULFATE TEST RESULTS
CALIFORNIA TEST NO. 417**

Sample No.	Water-Soluble Sulfate	Sulfate Exposure
B9-5	0.009%	Negligible
B11-1	0.005%	Negligible

**TABLE G-IV
SUMMARY OF HYDRAULIC CONDUCTIVITY TESTS
ASTM D 5084-03**

Sample No.	Average Permeability, Cm/Sec
B4-4	4.16 x 10 ⁻⁶
B9-5	1.21 x 10 ⁻⁵
B11-2	5.78 x 10 ⁻⁵

GRAVEL		SAND			SILT OR CLAY
COARSE	FINE	COARSE	MEDIUM	FINE	

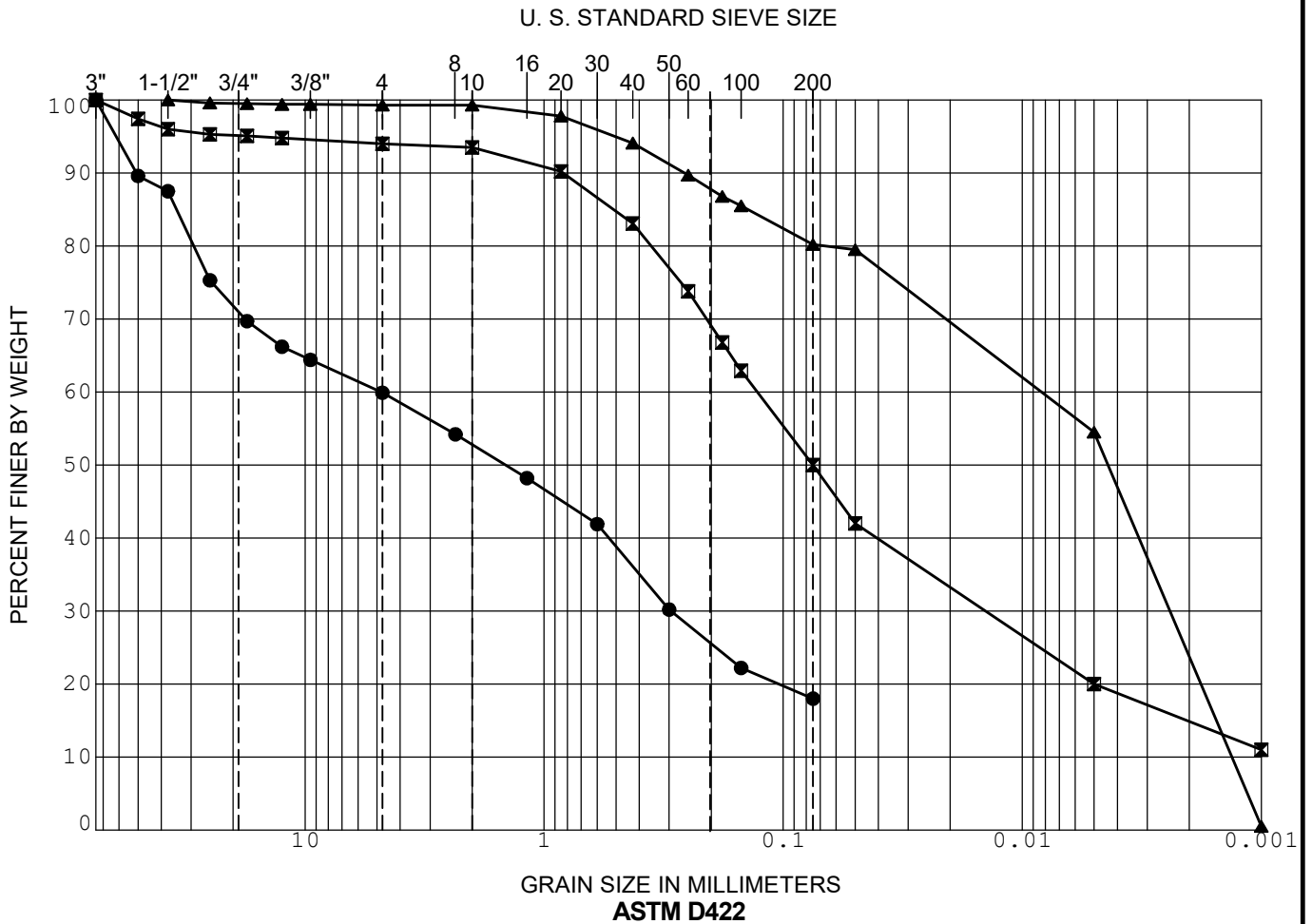

	SAMPLE	DEPTH (ft)	CLASSIFICATION	NAT WC	LL	PL	PI
●	B2-4	10.0	(SM) Brown, Silty SAND with gravel				
☒	B4-3	14.0	(MH) Green brown, Clayey SILT		56	35	21
▲	B4-7	27.0	(MH) Dark green, Clayey SILT		67	37	30

GRADATION CURVE

FANITA RANCH

SANTEE, CALIFORNIA

GRAVEL		SAND			SILT OR CLAY
COARSE	FINE	COARSE	MEDIUM	FINE	

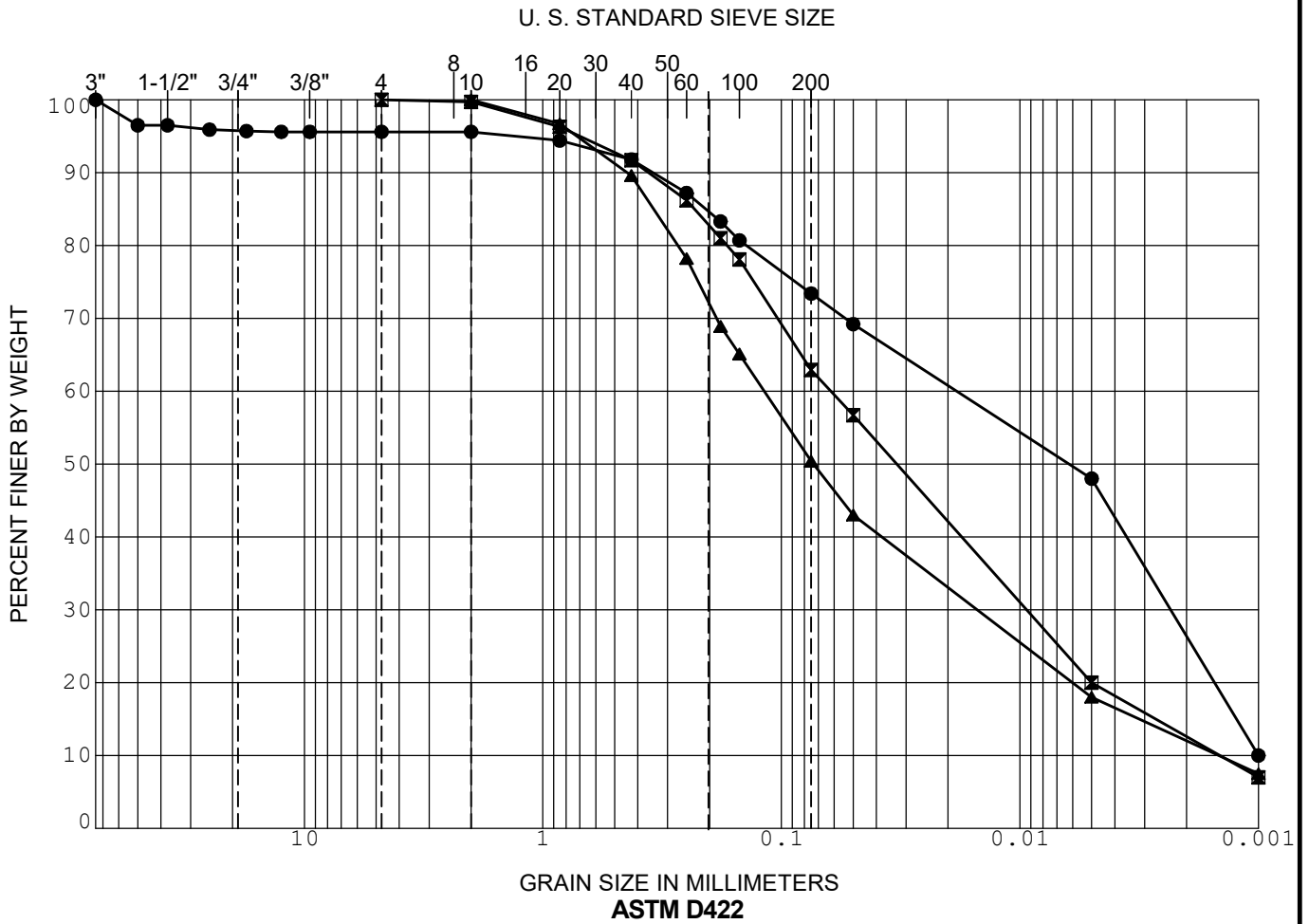

	SAMPLE	DEPTH (ft)	CLASSIFICATION	NAT WC	LL	PL	PI
●	B5-4	14.0	(MH) Green maroon, Clayey SILT		61	34	27
☒	B9-5	14.0	(MH) Green maroon, Clayey SILT		59	41	18
▲	B9-9	28.0	(MH) Green maroon, Clayey SILT		53	34	19

GRADATION CURVE

FANITA RANCH

SANTEE, CALIFORNIA

GRAVEL		SAND			SILT OR CLAY
COARSE	FINE	COARSE	MEDIUM	FINE	

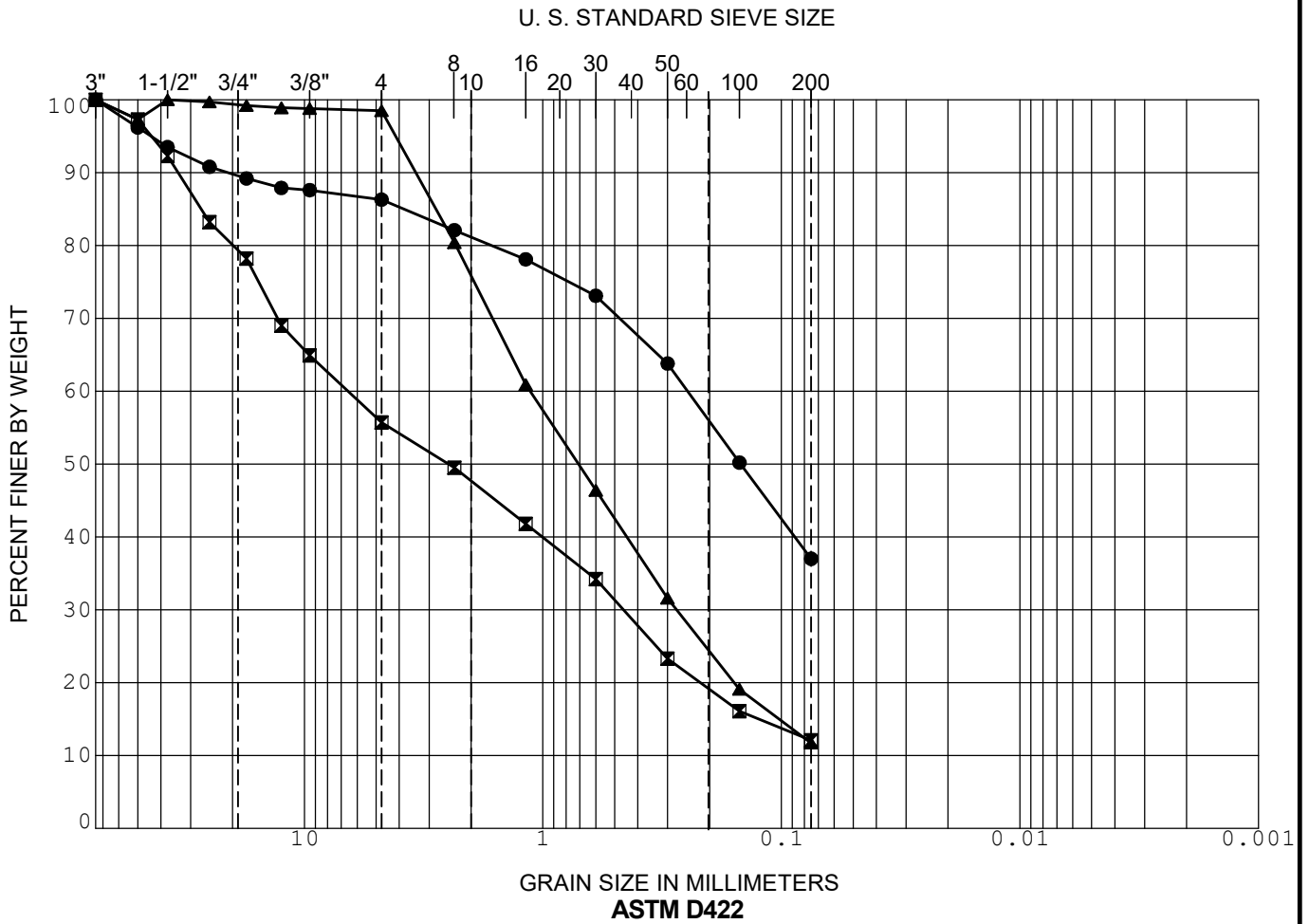

	SAMPLE	DEPTH (ft)	CLASSIFICATION	NAT WC	LL	PL	PI
●	B10-1	6.0	(SC) Clayey SAND				
☒	B11-1	3.0	(SC) Gravelly SAND				
▲	B11-2	9.0	(SM-SW) Slightly Silty SAND				

GRADATION CURVE

FANITA RANCH

SANTEE, CALIFORNIA

GRAVEL		SAND			SILT OR CLAY
COARSE	FINE	COARSE	MEDIUM	FINE	

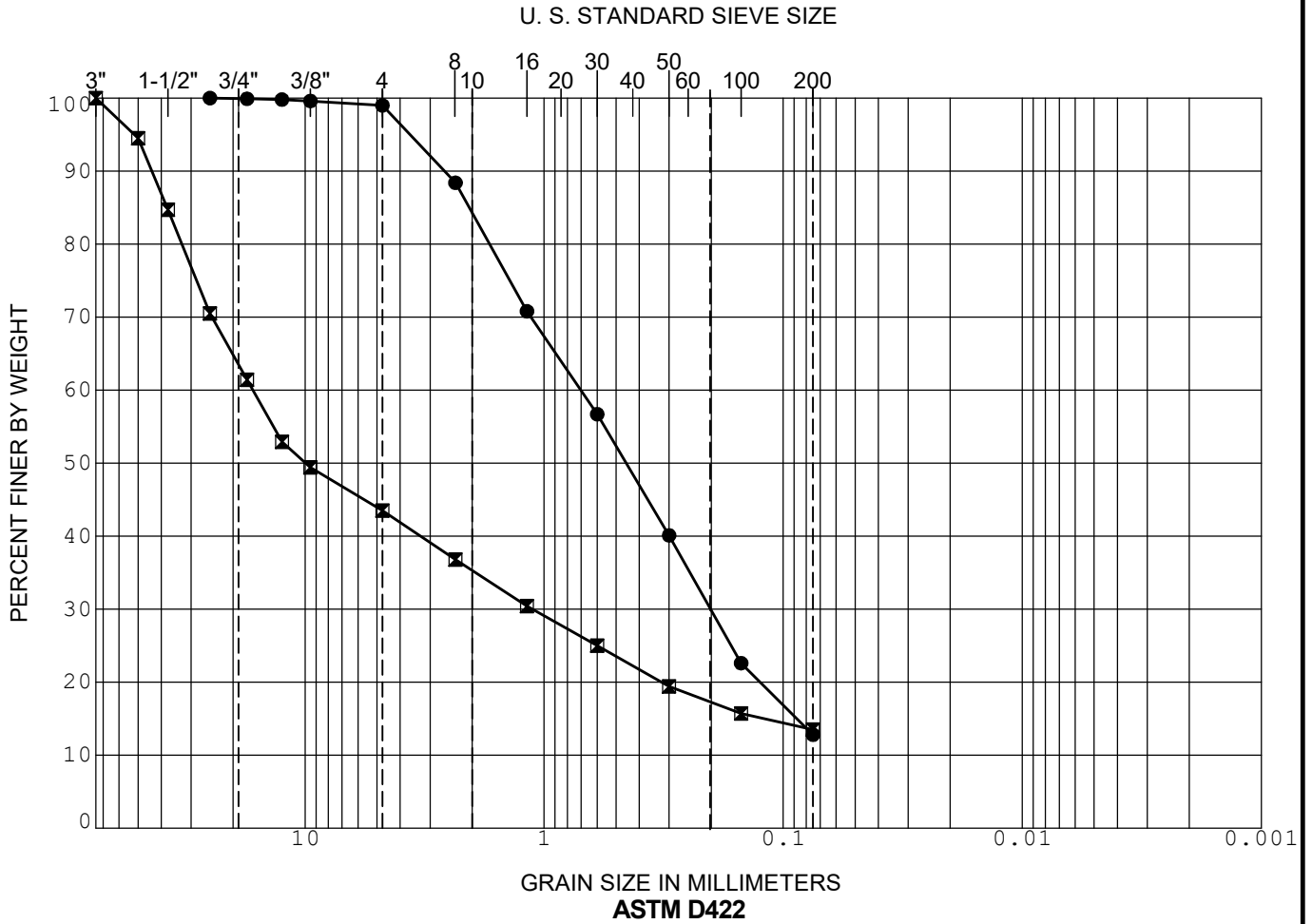

SAMPLE	DEPTH (ft)	CLASSIFICATION	NAT WC	LL	PL	PI
● T6-2	4.0	(SM) Brown, Silty SAND				
■ T7-2	5.5	(GM) Sandy GRAVEL				
▲						

GRADATION CURVE

FANITA RANCH

SANTEE, CALIFORNIA

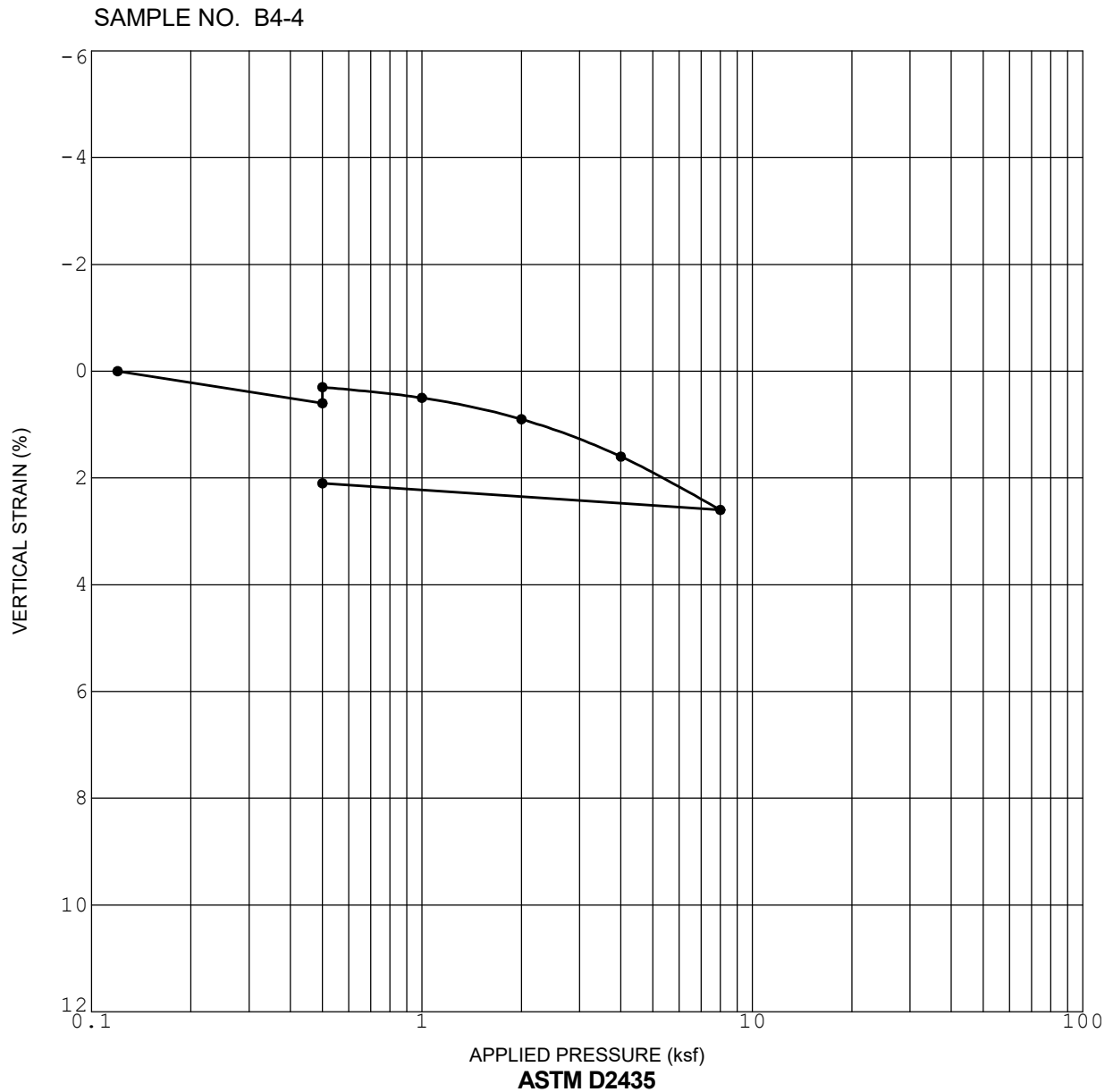

ASTM D2435

Initial Dry Density (pcf)	99.2
Initial Water Content (%)	24.9

Initial Saturation (%)	100+
Sample Saturated at (ksf)	0.5

CONSOLIDATION CURVE

FANITA RANCH

SANTEE, CALIFORNIA

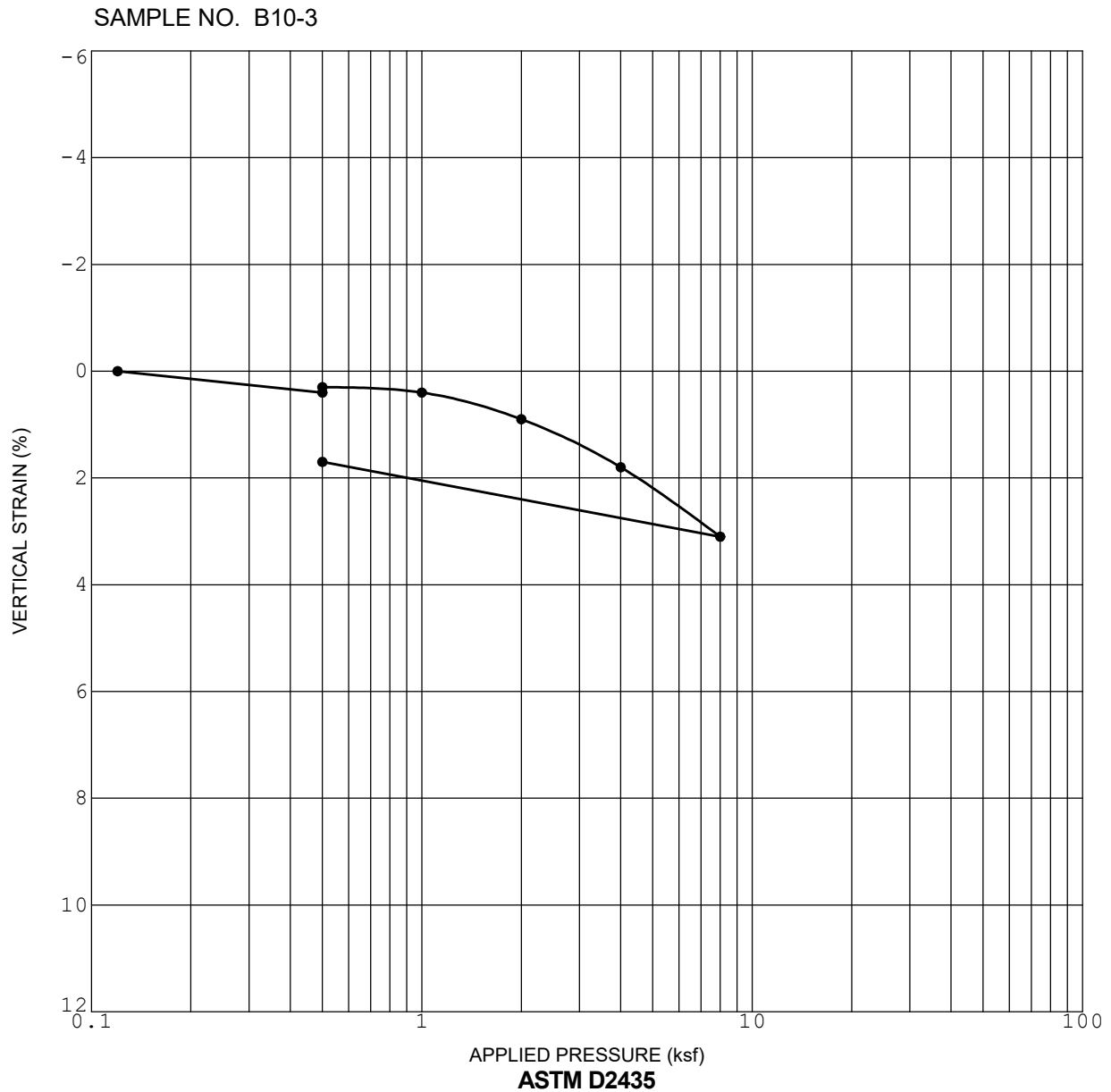

Initial Dry Density (pcf)	95.9
Initial Water Content (%)	27.1

Initial Saturation (%)	98.4
Sample Saturated at (ksf)	0.5

CONSOLIDATION CURVE

FANITA RANCH

SANTEE, CALIFORNIA

TRIAXIAL SHEAR STRENGTH - CU TEST
ASTM D4767

Project Name: FANITA RANCH
 Project Number: 05254-32-13
 Sample Number: B5-5

		SAMPLE ID:	1	2	3
INITIAL CONDITIONS AT START OF TEST	HEIGHT (in.)		4.98	4.89	4.83
	DIAMETER (in.)		2.37	2.38	2.38
	MOISTURE CONTENT (%)		33.2		
	SATURATION (%)		83.0		
	DRY DENSITY (pcf)		85.7		
AFTER SATURATION	DRY DENSITY (pcf)		85.7		
AFTER CONSOLIDATION	DRY DENSITY (pcf)		86.7		
SHEAR TEST CONDITIONS	DRY DENSITY (pcf)		86.7	87.7	89.0
	MOISTURE CONTENT (%)				37.2
	SATURATION (%)				99.8
	STRAIN RATE (%/min)		0.0451	0.0645	0.0343
	CELL PRESSURE (psf)		6760	7770	9810
	INITIAL BACK PRESSURE (psf)		5760	5800	5800
	INITIAL EFF CONFINING PRESS (psf)		1000	1970	4010
	TOTAL MAJOR PRIN STR AT FAIL (psf)		2200	3960	7940
	EFF MAJOR PRIN STR AT FAIL (psf)		1830	3310	7070
	PORE PRESSURE AT FAIL (psf)		360	650	880
EFF MINOR PRIN STR AT FAIL (psf)		630	1320	3130	

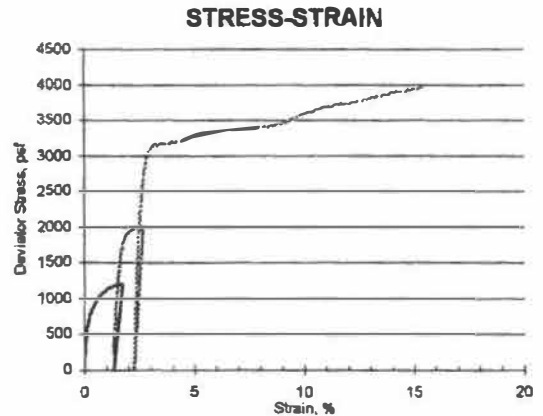
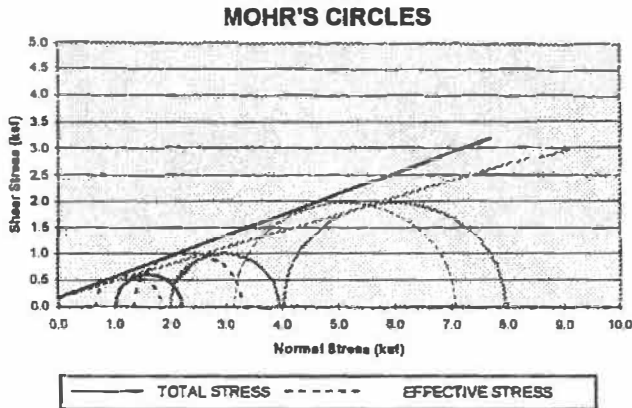

Strength Parameters: at maximum stress ratio
 for each stage

	TOTAL	EFFECTIVE:
ϕ , degrees	17.6	21.5
c, psf	170	170



GEOCON

3160 Gold Valley Drive, Suite 800
 Rancho Cordova, CA 95742
 tel. 916.852-9118 fax. 916.852.9132

Figure E-7

TRIAxIAL SHEAR STRENGTH - CU TEST
ASTM D4767

Project Name: FANITA RANCH
Project Number: 05254-32-13
Sample Number: B9-5

		SAMPLE ID:	1	2	3
INITIAL CONDITIONS AT START OF TEST	HEIGHT (in.)		5.00	5.00	5.00
	DIAMETER (in.)		2.42	2.42	2.42
	MOISTURE CONTENT (%)		19.5	20.4	21.2
	SATURATION (%)		59.0	64.4	65.9
	DRY DENSITY (pcf)		92.8	91.7	91.1
AFTER SATURATION	DRY DENSITY (pcf)		87.7	86.6	86.8
AFTER CONSOLIDATION	DRY DENSITY (pcf)		88.2	87.0	88.3
SHEAR TEST CONDITIONS	DRY DENSITY (pcf)		88.0	86.7	88.0
	MOISTURE CONTENT (%)		36.5	35.6	34.4
	SATURATION (%)		99.6	99.8	99.6
	STRAIN RATE (%/min)		0.0503	0.0502	0.0503
	CELL PRESSURE (psf)		9660	12120	14130
	INITIAL BACK PRESSURE (psf)		8670	10130	10130
	INITIAL EFF CONFINING PRESS (psf)		990	1990	4000
	TOTAL MAJOR PRIN STR AT FAIL (psf)		2450	4060	7880
	EFF MAJOR PRIN STR AT FAIL (psf)		1890	2780	5460
	PORE PRESSURE AT FAIL (psf)		560	1280	2420
EFF MINOR PRIN STR AT FAIL (psf)		430	720	1580	

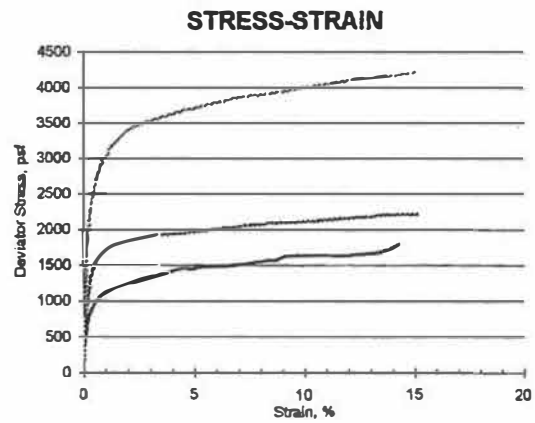
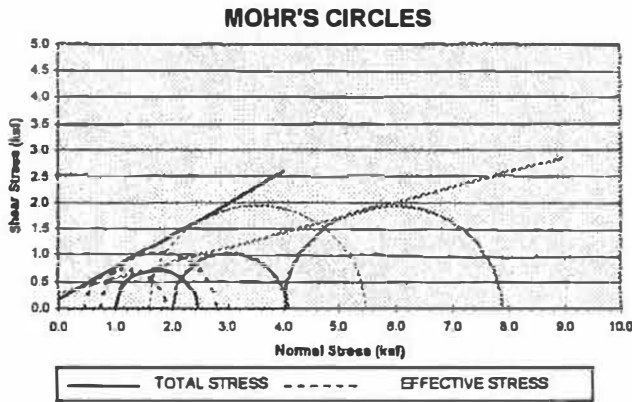

Strength Parameters: at maximum stress ratio
for each stage

	TOTAL	EFFECTIVE:
ϕ , degrees	16.1	31.2
c, psf	280	170



GEOCON

3160 Gold Valley Drive, Suite 800
Rancho Cordova, CA 95742
tel. 916.852-9118 fax. 916.852.9132

Figure E-8

TRIAXIAL SHEAR STRENGTH - CU TEST
ASTM D4767

Project Name: FANITA RANCH
 Project Number: 05254-32-13
 Sample Number: B11-2 B11-2 B11-2

SAMPLE ID: 1 2 3

INITIAL CONDITIONS AT START OF SATURATION	HEIGHT (in.)	5.00	5.00	5.00
	DIAMETER (in.)	2.42	2.42	2.42
	MOISTURE CONTENT (%)	11.4	11.5	11.1
	DRY DENSITY (pcf)	112.7	112.7	113.0
	SATURATION (%)	58.6	59.2	57.7
AFTER CONSOLIDATION	MOISTURE CONTENT (%)	19.1	18.7	17.8
	DRY DENSITY (pcf)	113.4	113.9	114.8
	SATURATION (%)	99.9	99.4	96.7
SHEAR TEST CONDITIONS	STRAIN RATE (%/min)	0.0807	0.0830	0.0813
	CELL PRESSURE (psf)	12570	13570	15550
	INITIAL BACK PRESSURE (psf)	11570	11560	11550
	TOTAL MAJOR PRIN STR AT FAIL (psf)	4920	8540	15100
	TOTAL MINOR PRIN STR AT FAIL (psf)	1000	2010	4000
	EXPELLED WATER AT FAIL (ml)	0	0	0

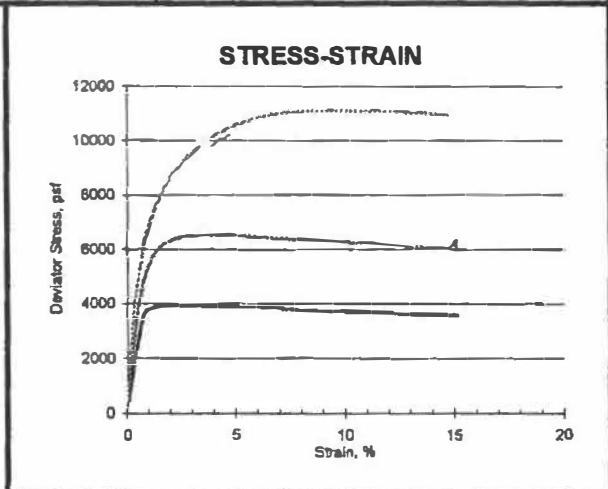
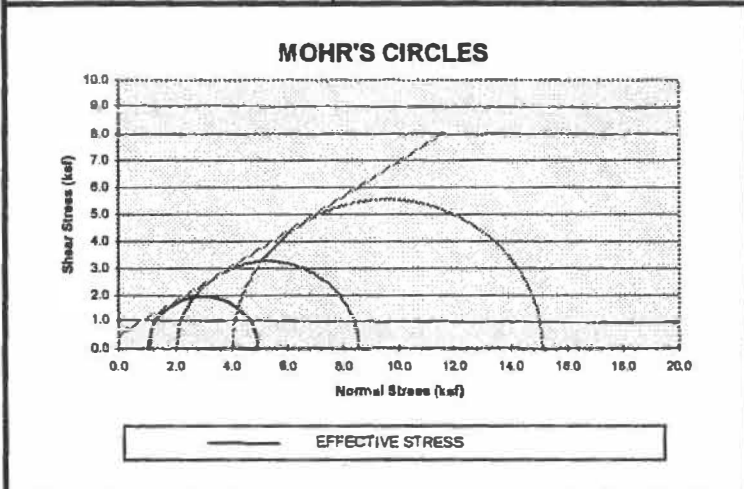

Strength Parameters:

ϕ , degrees 32.9
 c, psf 500



GEOCON

3160 Gold Valley Drive, Suite 800
 Rancho Cordova, CA 95742
 tel. 916.852-9118 fax. 916.852.9132

Figure E-9

Hydraulic Conductivity (ASTM D5084)

Project Name:	FANITA RANCH	Cell Pressure (psi)	66.9
Project Number:	05254-32-13	In Pressure (psi)	60
Beginning Test Date:	1/10/2007	Out Pressure (psi)	60
Ending Test Date:	1/11/2007	Burette area (cm ²)	0.872
Sample ID:	B9-5	Burette Correction (cm/ml)	1.147
Sample Description:	yellowish brown sandy SILT		

Estimated Specific Gravity: 3.00

	1	2	3	AVG (inches)	AVG (cm)
Initial Height (in.)	5	5	5	5.00	12.70
Final Height (in.)	5.12	5.12	5.12	5.12	13.00
Initial Diameter (in.)	2.42	2.42	2.42	2.42	6.15
Final Diameter (in.)	2.46	2.46	2.46	2.46	6.25
Initial Area				4.60	29.67
Initial Volume (ft ³)	0.01331				Final Volume (ft ³) 0.01408
Initial Volume (cm ³)	376.9				Final Volume (cm ³) 398.8

	Weight (grams)	Moisture Content (%)	Wet Density (pcf)	Dry Density (pcf)	Void Ratio	Saturation (%)
Initial	669.1	17.7	110.8	94.2	0.988	53.7
Final	776	36.5	121.5	89.0	1.103	99.2
Dry	568.5					

Beginning Date &	End Date & Time	Elapsed Time (sec.)	Burette Out (ml)	Burette In (ml)	Pressure Head (cm)	Gradient	H1 (cm)	H2 (cm)	Permeability (cm/s)
1/10/07 7:39 AM			24.00	0.00		2.2	27.5		
	1/10/07 8:49 AM	4200	21.10	2.70		1.7		21.1	1.21E-05
1/10/07 8:47 AM		4,200	21.10	2.70		1.7	21.1		
	1/10/07 9:11 AM	1440	20.40	3.45		1.5		19.4	1.21E-05
1/10/07 9:11 AM		5,640	20.40	3.45		1.5	19.4		
	1/10/07 10:25 AM	4440	18.25	5.55		1.1		14.6	1.21E-05
1/10/07 2:06 PM		10,080	24.50	0.30		2.2	27.8		
	1/10/07 3:43 PM	5820	20.50	4.20		1.5		18.7	1.21E-05
1/10/07 3:43 PM		15,900	20.50	4.20		1.5	18.7		
	1/10/07 4:02 PM	1140	19.90	4.80		1.4		17.3	1.21E-05
1/10/07 4:02 PM		17,040	19.90	4.80		1.4	17.3		
	1/10/07 4:32 PM	1800	19.00	5.70		1.2		15.3	1.21E-05
1/11/07 7:37 AM		18,840	24.00	0.30		2.1	27.2		
	1/11/07 8:15 AM	2280	22.35	1.90		1.8		23.5	1.21E-05
		21,120							

Average Permeability (cm/s): 1.21E-05
Permeability @ 20°C: 1.17E-05

Notes:

Average temperature during test = 21.4°C
Tap water utilized as permeant

Tested By: P. Oswald

Calculated By:

Reviewed By:

Figure E-11

Hydraulic Conductivity (ASTM D5084)

Project Name:	FANITA RANCH	Cell Pressure (psi)	93.9
Project Number:	05254-32-13	In Pressure (psi)	80
Beginning Test Date:	12/28/2006	Out Pressure (psi)	80
Ending Test Date:	1/3/2007	Burette area (cm ²)	0.872
Sample ID:	B11-2	Burette Correction (cm/ml)	1.147
Sample Description:	Dark yellowish brown well graded SAND with silt and clay		
Estimated Specific Gravity:	2.75		

	1	2	3	AVG (inches)	AVG (cm)
Initial Height (in.)	5	5	5	5.00	12.70
Final Height (in.)	5.00	5.00	5.00	5.00	12.70
Initial Diameter (in.)	2.42	2.4	2.38	2.40	6.10
Final Diameter (in.)	2.42	2.42	2.42	2.42	6.15
Initial Area				4.52	29.19
Initial Volume (ft ³)	0.01309	Final Volume (ft ³)		0.01331	
Initial Volume (cm ³)	370.7	Final Volume (cm ³)		376.9	

	Weight (grams)	Moisture Content (%)	Wet Density (pcf)	Dry Density (pcf)	Void Ratio	Saturation (%)
Initial	758.4	11.7	127.7	114.3	0.501	64.3
Final	808	19.0	133.8	112.5	0.526	99.4
Dry	678.9					

Beginning Date & Time	End Date & Time	Elapsed Time (sec.)	Burette Out (ml)	Burette In (ml)	Pressure Head (cm)	Gradient	H1 (cm)	H2 (cm)	Permeability (cm/s)
1/4/07 7:28 AM			23.65	1.10		2.0	25.9		
	1/4/07 7:44 AM	960	20.35	4.20		1.5	18.5		6.60E-05
1/4/07 7:44 AM		960	20.35	4.20		1.5	18.5		
	1/4/07 8:01 AM	1020	18.15	6.50		1.1	13.4		6.07E-05
1/4/07 8:01 AM		1,980	18.15	6.50		1.1	13.4		
	1/4/07 8:21 AM	1200	15.85	8.80		0.6	8.1		7.94E-05
1/4/07 8:26 AM		3,180	23.60	1.15		2.0	25.8		
	1/4/07 8:47 AM	1260	19.60	5.15		1.3	16.6		6.63E-05
1/4/07 8:47 AM		4,440	19.60	5.15		1.3	16.6		
	1/4/07 9:06 AM	1140	16.75	7.95		0.8	10.1		8.25E-05
1/4/07 9:52 AM		5,580	18.35	6.50		1.1	13.6		
	1/4/07 10:10 AM	1080	16.50	8.35		0.7	9.3		6.58E-05
1/4/07 10:10 AM		6,660	16.50	8.35		0.7	9.3		
	1/4/07 10:22 AM	720	15.55	9.40		0.6	7.1		7.42E-05
1/4/07 10:27 AM		7,380	23.00	1.50		1.9	24.7		
	1/4/07 10:38 AM	660	20.45	4.00		1.5	18.9		7.70E-05
		8,040							

Average Permeability (cm/s): **7.15E-05**
Permeability @ 20°C **6.98E-05**

Notes:

Average temperature during test = 21.0°C
Tap water utilized as permeant

Tested By: P. Oswald

Calculated By:

Reviewed By:

Figure E-12

APPENDIX



APPENDIX H

RECOMMENDED GRADING SPECIFICATIONS

FOR

FANITA RANCH
FANITA COMMONS, ORCHARD VILLAGE AND VINEYARD VILLAGE
SANTEE, CALIFORNIA

PROJECT NO. 05254-32-18A

RECOMMENDED GRADING SPECIFICATIONS

1. GENERAL

- 1.1 These Recommended Grading Specifications shall be used in conjunction with the Geotechnical Report for the project prepared by Geocon. The recommendations contained in the text of the Geotechnical Report are a part of the earthwork and grading specifications and shall supersede the provisions contained hereinafter in the case of conflict.
- 1.2 Prior to the commencement of grading, a geotechnical consultant (Consultant) shall be employed for the purpose of observing earthwork procedures and testing the fills for substantial conformance with the recommendations of the Geotechnical Report and these specifications. The Consultant should provide adequate testing and observation services so that they may assess whether, in their opinion, the work was performed in substantial conformance with these specifications. It shall be the responsibility of the Contractor to assist the Consultant and keep them apprised of work schedules and changes so that personnel may be scheduled accordingly.
- 1.3 It shall be the sole responsibility of the Contractor to provide adequate equipment and methods to accomplish the work in accordance with applicable grading codes or agency ordinances, these specifications and the approved grading plans. If, in the opinion of the Consultant, unsatisfactory conditions such as questionable soil materials, poor moisture condition, inadequate compaction, and/or adverse weather result in a quality of work not in conformance with these specifications, the Consultant will be empowered to reject the work and recommend to the Owner that grading be stopped until the unacceptable conditions are corrected.

2. DEFINITIONS

- 2.1 **Owner** shall refer to the owner of the property or the entity on whose behalf the grading work is being performed and who has contracted with the Contractor to have grading performed.
- 2.2 **Contractor** shall refer to the Contractor performing the site grading work.
- 2.3 **Civil Engineer** or **Engineer of Work** shall refer to the California licensed Civil Engineer or consulting firm responsible for preparation of the grading plans, surveying and verifying as-graded topography.
- 2.4 **Consultant** shall refer to the soil engineering and engineering geology consulting firm retained to provide geotechnical services for the project.

- 2.5 **Soil Engineer** shall refer to a California licensed Civil Engineer retained by the Owner, who is experienced in the practice of geotechnical engineering. The Soil Engineer shall be responsible for having qualified representatives on-site to observe and test the Contractor's work for conformance with these specifications.
- 2.6 **Engineering Geologist** shall refer to a California licensed Engineering Geologist retained by the Owner to provide geologic observations and recommendations during the site grading.
- 2.7 **Geotechnical Report** shall refer to a soil report (including all addenda) which may include a geologic reconnaissance or geologic investigation that was prepared specifically for the development of the project for which these Recommended Grading Specifications are intended to apply.

3. MATERIALS

- 3.1 Materials for compacted fill shall consist of any soil excavated from the cut areas or imported to the site that, in the opinion of the Consultant, is suitable for use in construction of fills. In general, fill materials can be classified as *soil* fills, *soil-rock* fills or *rock* fills, as defined below.
- 3.1.1 **Soil fills** are defined as fills containing no rocks or hard lumps greater than 12 inches in maximum dimension and containing at least 40 percent by weight of material smaller than $\frac{3}{4}$ inch in size.
- 3.1.2 **Soil-rock fills** are defined as fills containing no rocks or hard lumps larger than 4 feet in maximum dimension and containing a sufficient matrix of soil fill to allow for proper compaction of soil fill around the rock fragments or hard lumps as specified in Paragraph 6.2. **Oversize rock** is defined as material greater than 12 inches.
- 3.1.3 **Rock fills** are defined as fills containing no rocks or hard lumps larger than 3 feet in maximum dimension and containing little or no fines. Fines are defined as material smaller than $\frac{3}{4}$ inch in maximum dimension. The quantity of fines shall be less than approximately 20 percent of the rock fill quantity.
- 3.2 Material of a perishable, spongy, or otherwise unsuitable nature as determined by the Consultant shall not be used in fills.
- 3.3 Materials used for fill, either imported or on-site, shall not contain hazardous materials as defined by the California Code of Regulations, Title 22, Division 4, Chapter 30, Articles 9

and 10; 40CFR; and any other applicable local, state or federal laws. The Consultant shall not be responsible for the identification or analysis of the potential presence of hazardous materials. However, if observations, odors or soil discoloration cause Consultant to suspect the presence of hazardous materials, the Consultant may request from the Owner the termination of grading operations within the affected area. Prior to resuming grading operations, the Owner shall provide a written report to the Consultant indicating that the suspected materials are not hazardous as defined by applicable laws and regulations.

- 3.4 The outer 15 feet of *soil-rock* fill slopes, measured horizontally, should be composed of properly compacted *soil* fill materials approved by the Consultant. *Rock* fill may extend to the slope face, provided that the slope is not steeper than 2:1 (horizontal:vertical) and a soil layer no thicker than 12 inches is track-walked onto the face for landscaping purposes. This procedure may be utilized provided it is acceptable to the governing agency, Owner and Consultant.
- 3.5 Samples of soil materials to be used for fill should be tested in the laboratory by the Consultant to determine the maximum density, optimum moisture content, and, where appropriate, shear strength, expansion, and gradation characteristics of the soil.
- 3.6 During grading, soil or groundwater conditions other than those identified in the Geotechnical Report may be encountered by the Contractor. The Consultant shall be notified immediately to evaluate the significance of the unanticipated condition.

4. CLEARING AND PREPARING AREAS TO BE FILLED

- 4.1 Areas to be excavated and filled shall be cleared and grubbed. Clearing shall consist of complete removal above the ground surface of trees, stumps, brush, vegetation, man-made structures, and similar debris. Grubbing shall consist of removal of stumps, roots, buried logs and other unsuitable material and shall be performed in areas to be graded. Roots and other projections exceeding 1½ inches in diameter shall be removed to a depth of 3 feet below the surface of the ground. Borrow areas shall be grubbed to the extent necessary to provide suitable fill materials.
- 4.2 Asphalt pavement material removed during clearing operations should be properly disposed at an approved off-site facility or in an acceptable area of the project evaluated by Geocon and the property owner. Concrete fragments that are free of reinforcing steel may be placed in fills, provided they are placed in accordance with Section 6.2 or 6.3 of this document.

- 4.3 After clearing and grubbing of organic matter and other unsuitable material, loose or porous soils shall be removed to the depth recommended in the Geotechnical Report. The depth of removal and compaction should be observed and approved by a representative of the Consultant. The exposed surface shall then be plowed or scarified to a minimum depth of 6 inches and until the surface is free from uneven features that would tend to prevent uniform compaction by the equipment to be used.
- 4.4 Where the slope ratio of the original ground is steeper than 5:1 (horizontal:vertical), or where recommended by the Consultant, the original ground should be benched in accordance with the following illustration.

TYPICAL BENCHING DETAIL

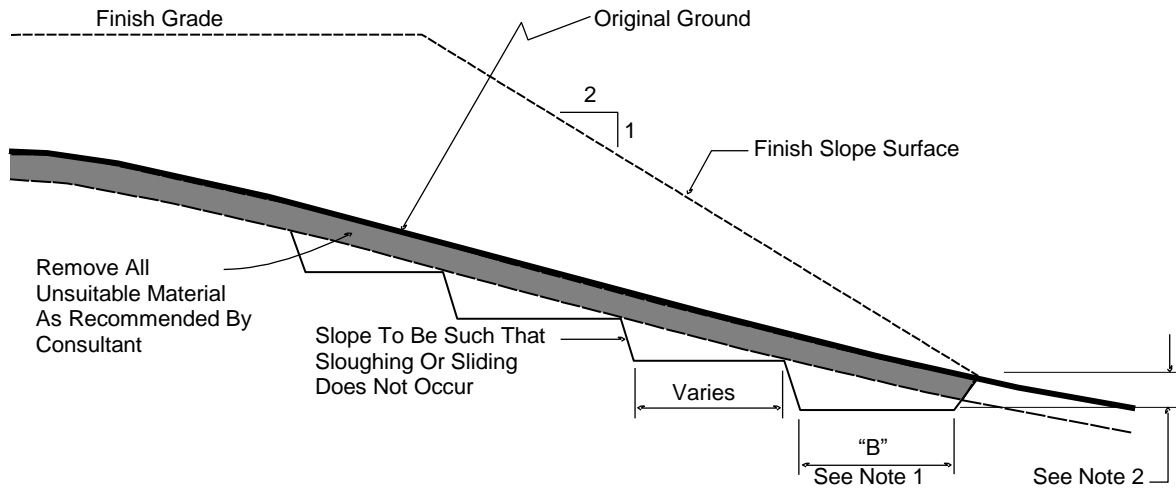

No Scale

- DETAIL NOTES:
- (1) Key width "B" should be a minimum of 10 feet, or sufficiently wide to permit complete coverage with the compaction equipment used. The base of the key should be graded horizontal, or inclined slightly into the natural slope.
 - (2) The outside of the key should be below the topsoil or unsuitable surficial material and at least 2 feet into dense formational material. Where hard rock is exposed in the bottom of the key, the depth and configuration of the key may be modified as approved by the Consultant.

- 4.5 After areas to receive fill have been cleared and scarified, the surface should be moisture conditioned to achieve the proper moisture content, and compacted as recommended in Section 6 of these specifications.

5. COMPACTION EQUIPMENT

- 5.1 Compaction of *soil* or *soil-rock* fill shall be accomplished by sheepsfoot or segmented-steel wheeled rollers, vibratory rollers, multiple-wheel pneumatic-tired rollers, or other types of acceptable compaction equipment. Equipment shall be of such a design that it will be capable of compacting the *soil* or *soil-rock* fill to the specified relative compaction at the specified moisture content.
- 5.2 Compaction of *rock* fills shall be performed in accordance with Section 6.3.

6. PLACING, SPREADING AND COMPACTION OF FILL MATERIAL

- 6.1 *Soil* fill, as defined in Paragraph 3.1.1, shall be placed by the Contractor in accordance with the following recommendations:
- 6.1.1 *Soil* fill shall be placed by the Contractor in layers that, when compacted, should generally not exceed 8 inches. Each layer shall be spread evenly and shall be thoroughly mixed during spreading to obtain uniformity of material and moisture in each layer. The entire fill shall be constructed as a unit in nearly level lifts. Rock materials greater than 12 inches in maximum dimension shall be placed in accordance with Section 6.2 or 6.3 of these specifications.
- 6.1.2 In general, the *soil* fill shall be compacted at a moisture content at or above the optimum moisture content as determined by ASTM D 1557.
- 6.1.3 When the moisture content of *soil* fill is below that specified by the Consultant, water shall be added by the Contractor until the moisture content is in the range specified.
- 6.1.4 When the moisture content of the *soil* fill is above the range specified by the Consultant or too wet to achieve proper compaction, the *soil* fill shall be aerated by the Contractor by blading/mixing, or other satisfactory methods until the moisture content is within the range specified.
- 6.1.5 After each layer has been placed, mixed, and spread evenly, it shall be thoroughly compacted by the Contractor to a relative compaction of at least 90 percent. Relative compaction is defined as the ratio (expressed in percent) of the in-place dry density of the compacted fill to the maximum laboratory dry density as determined in accordance with ASTM D 1557. Compaction shall be continuous over the entire area, and compaction equipment shall make sufficient passes so that the specified minimum relative compaction has been achieved throughout the entire fill.

- 6.1.6 Where practical, soils having an Expansion Index greater than 50 should be placed at least 3 feet below finish pad grade and should be compacted at a moisture content generally 2 to 4 percent greater than the optimum moisture content for the material.
 - 6.1.7 Properly compacted *soil* fill shall extend to the design surface of fill slopes. To achieve proper compaction, it is recommended that fill slopes be over-built by at least 3 feet and then cut to the design grade. This procedure is considered preferable to track-walking of slopes, as described in the following paragraph.
 - 6.1.8 As an alternative to over-building of slopes, slope faces may be back-rolled with a heavy-duty loaded sheepsfoot or vibratory roller at maximum 4-foot fill height intervals. Upon completion, slopes should then be track-walked with a D-8 dozer or similar equipment, such that a dozer track covers all slope surfaces at least twice.
- 6.2 *Soil-rock* fill, as defined in Paragraph 3.1.2, shall be placed by the Contractor in accordance with the following recommendations:
- 6.2.1 Rocks larger than 12 inches but less than 4 feet in maximum dimension may be incorporated into the compacted *soil* fill, but shall be limited to the area measured 15 feet minimum horizontally from the slope face and 5 feet below finish grade or 3 feet below the deepest utility, whichever is deeper.
 - 6.2.2 Rocks or rock fragments up to 4 feet in maximum dimension may either be individually placed or placed in windrows. Under certain conditions, rocks or rock fragments up to 10 feet in maximum dimension may be placed using similar methods. The acceptability of placing rock materials greater than 4 feet in maximum dimension shall be evaluated during grading as specific cases arise and shall be approved by the Consultant prior to placement.
 - 6.2.3 For individual placement, sufficient space shall be provided between rocks to allow for passage of compaction equipment.
 - 6.2.4 For windrow placement, the rocks should be placed in trenches excavated in properly compacted *soil* fill. Trenches should be approximately 5 feet wide and 4 feet deep in maximum dimension. The voids around and beneath rocks should be filled with approved granular soil having a Sand Equivalent of 30 or greater and should be compacted by flooding. Windrows may also be placed utilizing an "open-face" method in lieu of the trench procedure, however, this method should first be approved by the Consultant.

- 6.2.5 Windrows should generally be parallel to each other and may be placed either parallel to or perpendicular to the face of the slope depending on the site geometry. The minimum horizontal spacing for windrows shall be 12 feet center-to-center with a 5-foot stagger or offset from lower courses to next overlying course. The minimum vertical spacing between windrow courses shall be 2 feet from the top of a lower windrow to the bottom of the next higher windrow.
- 6.2.6 Rock placement, fill placement and flooding of approved granular soil in the windrows should be continuously observed by the Consultant.
- 6.3 *Rock* fills, as defined in Section 3.1.3, shall be placed by the Contractor in accordance with the following recommendations:
- 6.3.1 The base of the *rock* fill shall be placed on a sloping surface (minimum slope of 2 percent). The surface shall slope toward suitable subdrainage outlet facilities. The *rock* fills shall be provided with subdrains during construction so that a hydrostatic pressure buildup does not develop. The subdrains shall be permanently connected to controlled drainage facilities to control post-construction infiltration of water.
- 6.3.2 *Rock* fills shall be placed in lifts not exceeding 3 feet. Placement shall be by rock trucks traversing previously placed lifts and dumping at the edge of the currently placed lift. Spreading of the *rock* fill shall be by dozer to facilitate *seating* of the rock. The *rock* fill shall be watered heavily during placement. Watering shall consist of water trucks traversing in front of the current rock lift face and spraying water continuously during rock placement. Compaction equipment with compactive energy comparable to or greater than that of a 20-ton steel vibratory roller or other compaction equipment providing suitable energy to achieve the required compaction or deflection as recommended in Paragraph 6.3.3 shall be utilized. The number of passes to be made should be determined as described in Paragraph 6.3.3. Once a *rock* fill lift has been covered with *soil* fill, no additional *rock* fill lifts will be permitted over the *soil* fill.
- 6.3.3 Plate bearing tests, in accordance with ASTM D 1196, may be performed in both the compacted *soil* fill and in the *rock* fill to aid in determining the required minimum number of passes of the compaction equipment. If performed, a minimum of three plate bearing tests should be performed in the properly compacted *soil* fill (minimum relative compaction of 90 percent). Plate bearing tests shall then be performed on areas of *rock* fill having two passes, four passes and six passes of the compaction equipment, respectively. The number of passes required for the *rock* fill shall be determined by comparing the results of the plate bearing tests for the *soil* fill and the *rock* fill and by evaluating the deflection

variation with number of passes. The required number of passes of the compaction equipment will be performed as necessary until the plate bearing deflections are equal to or less than that determined for the properly compacted *soil* fill. In no case will the required number of passes be less than two.

- 6.3.4 A representative of the Consultant should be present during *rock* fill operations to observe that the minimum number of “passes” have been obtained, that water is being properly applied and that specified procedures are being followed. The actual number of plate bearing tests will be determined by the Consultant during grading.
- 6.3.5 Test pits shall be excavated by the Contractor so that the Consultant can state that, in their opinion, sufficient water is present and that voids between large rocks are properly filled with smaller rock material. In-place density testing will not be required in the *rock* fills.
- 6.3.6 To reduce the potential for “piping” of fines into the *rock* fill from overlying *soil* fill material, a 2-foot layer of graded filter material shall be placed above the uppermost lift of *rock* fill. The need to place graded filter material below the *rock* should be determined by the Consultant prior to commencing grading. The gradation of the graded filter material will be determined at the time the *rock* fill is being excavated. Materials typical of the *rock* fill should be submitted to the Consultant in a timely manner, to allow design of the graded filter prior to the commencement of *rock* fill placement.
- 6.3.7 *Rock* fill placement should be continuously observed during placement by the Consultant.

7. SUBDRAINS

- 7.1 The geologic units on the site may have permeability characteristics and/or fracture systems that could be susceptible under certain conditions to seepage. The use of canyon subdrains may be necessary to mitigate the potential for adverse impacts associated with seepage conditions. Canyon subdrains with lengths in excess of 500 feet or extensions of existing offsite subdrains should use 8-inch-diameter pipes. Canyon subdrains less than 500 feet in length should use 6-inch-diameter pipes.

TYPICAL CANYON DRAIN DETAIL

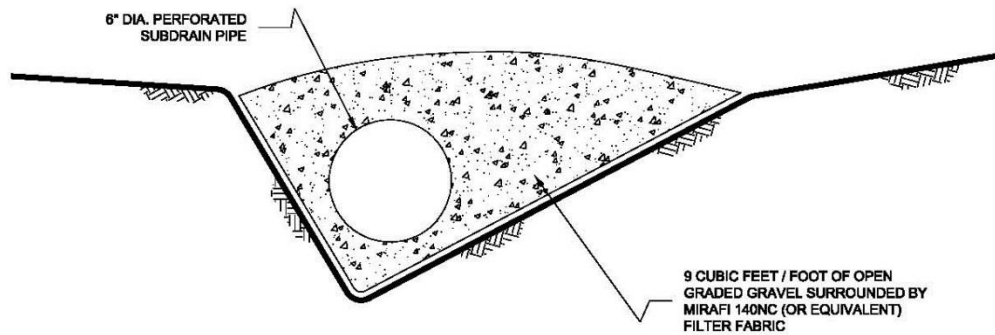
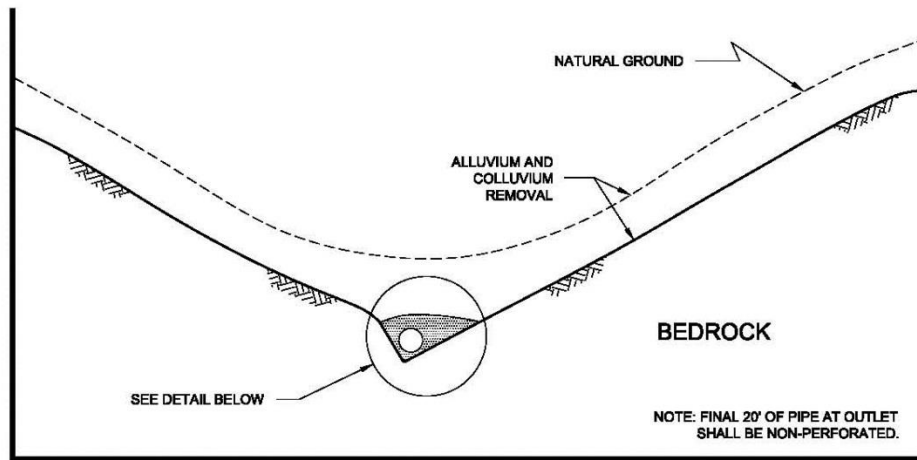

NOTES:

- 1.....8-INCH DIAMETER, SCHEDULE 80 PVC PERFORATED PIPE FOR FILLS IN EXCESS OF 100-FEET IN DEPTH OR A PIPE LENGTH OF LONGER THAN 500 FEET.
- 2.....6-INCH DIAMETER, SCHEDULE 40 PVC PERFORATED PIPE FOR FILLS LESS THAN 100-FEET IN DEPTH OR A PIPE LENGTH SHORTER THAN 500 FEET.

NO SCALE

7.2 Slope drains within stability fill keyways should use 4-inch-diameter (or larger) pipes.

TYPICAL STABILITY FILL DETAIL

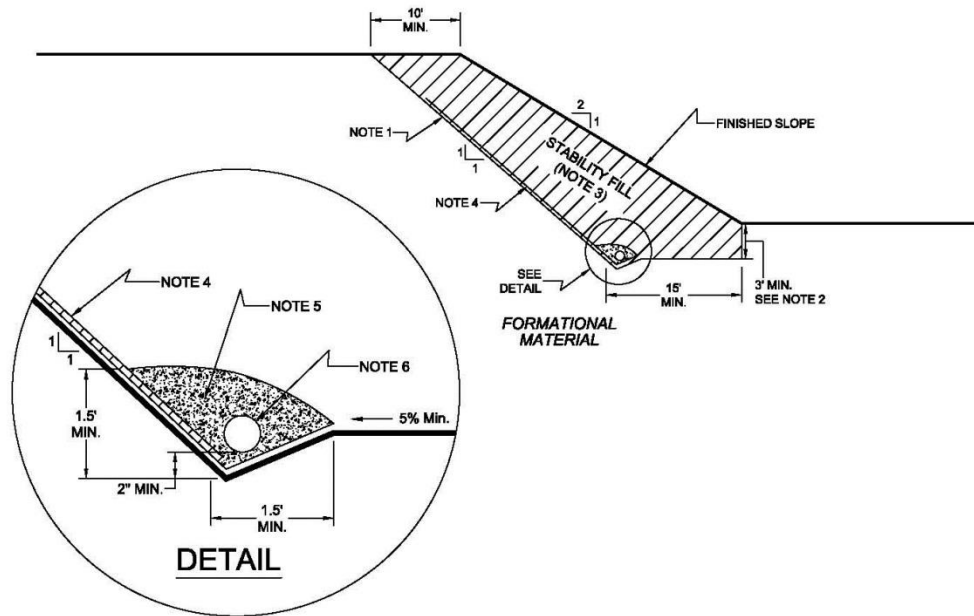

NOTES:

- 1.....EXCAVATE BACKCUT AT 1:1 INCLINATION (UNLESS OTHERWISE NOTED).
- 2.....BASE OF STABILITY FILL TO BE 3 FEET INTO FORMATIONAL MATERIAL, SLOPING A MINIMUM 5% INTO SLOPE.
- 3.....STABILITY FILL TO BE COMPOSED OF PROPERLY COMPACTED GRANULAR SOIL.
- 4.....CHIMNEY DRAINS TO BE APPROVED PREFABRICATED CHIMNEY DRAIN PANELS (MIRADRAIN G200N OR EQUIVALENT) SPACED APPROXIMATELY 20 FEET CENTER TO CENTER AND 4 FEET WIDE. CLOSER SPACING MAY BE REQUIRED IF SEEPAGE IS ENCOUNTERED.
- 5.....FILTER MATERIAL TO BE 3/4-INCH, OPEN-GRADED CRUSHED ROCK ENCLOSED IN APPROVED FILTER FABRIC (MIRAFI 140NC).
- 6.....COLLECTOR PIPE TO BE 4-INCH MINIMUM DIAMETER, PERFORATED, THICK-WALLED PVC SCHEDULE 40 OR EQUIVALENT, AND SLOPED TO DRAIN AT 1 PERCENT MINIMUM TO APPROVED OUTLET.

NO SCALE

- 7.3 The actual subdrain locations will be evaluated in the field during the remedial grading operations. Additional drains may be necessary depending on the conditions observed and the requirements of the local regulatory agencies. Appropriate subdrain outlets should be evaluated prior to finalizing 40-scale grading plans.
- 7.4 *Rock fill* or *soil-rock fill* areas may require subdrains along their down-slope perimeters to mitigate the potential for buildup of water from construction or landscape irrigation. The subdrains should be at least 6-inch-diameter pipes encapsulated in gravel and filter fabric. *Rock fill* drains should be constructed using the same requirements as canyon subdrains.

7.5 Prior to outletting, the final 20-foot segment of a subdrain that will not be extended during future development should consist of non-perforated drainpipe. At the non-perforated/perforated interface, a seepage cutoff wall should be constructed on the downslope side of the pipe.

TYPICAL CUT OFF WALL DETAIL

FRONT VIEW

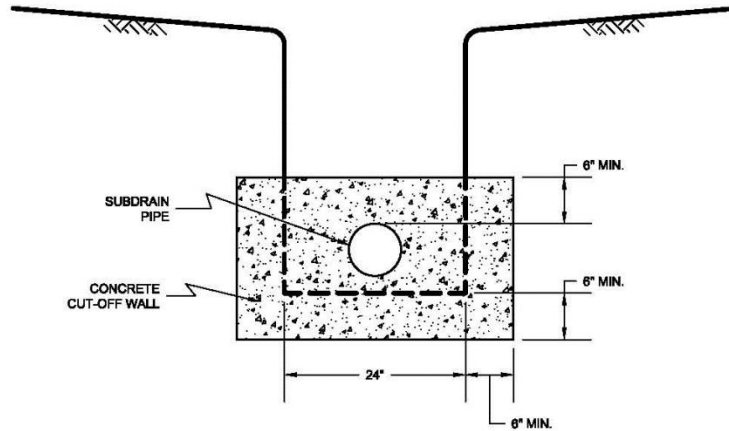

NO SCALE

SIDE VIEW

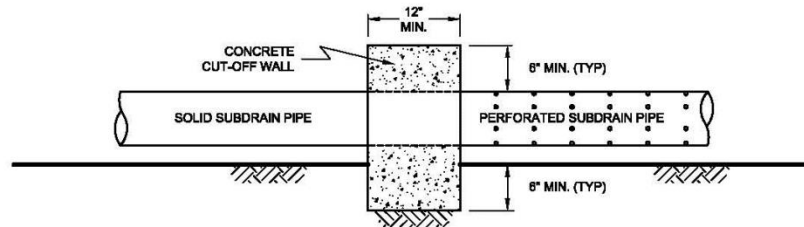

NO SCALE

7.6 Subdrains that discharge into a natural drainage course or open space area should be provided with a permanent headwall structure.

TYPICAL HEADWALL DETAIL

FRONT VIEW

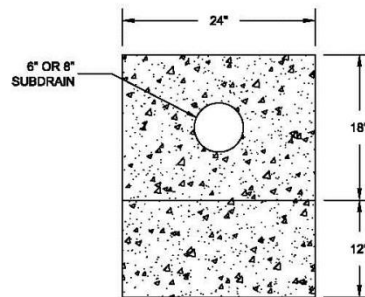

NO SCALE

SIDE VIEW

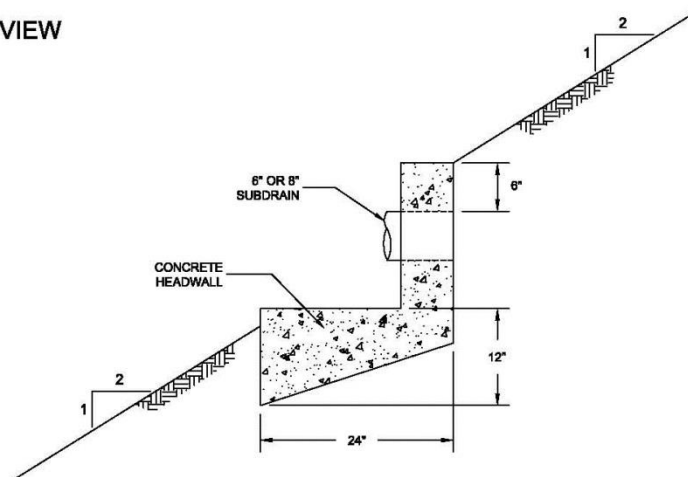

NOTE: HEADWALL SHOULD OUTLET AT TOE OF FILL SLOPE
OR INTO CONTROLLED SURFACE DRAINAGE

NO SCALE

- 7.7 The final grading plans should show the location of the proposed subdrains. After completion of remedial excavations and subdrain installation, the project civil engineer should survey the drain locations and prepare an “as-built” map showing the drain locations. The final outlet and connection locations should be determined during grading operations. Subdrains that will be extended on adjacent projects after grading can be placed on formational material and a vertical riser should be placed at the end of the subdrain. The grading contractor should consider videoing the subdrains shortly after burial to check proper installation and functionality. The contractor is responsible for the performance of the drains.

8. OBSERVATION AND TESTING

- 8.1 The Consultant shall be the Owner's representative to observe and perform tests during clearing, grubbing, filling, and compaction operations. In general, no more than 2 feet in vertical elevation of *soil* or *soil-rock* fill should be placed without at least one field density test being performed within that interval. In addition, a minimum of one field density test should be performed for every 2,000 cubic yards of *soil* or *soil-rock* fill placed and compacted.
- 8.2 The Consultant should perform a sufficient distribution of field density tests of the compacted *soil* or *soil-rock* fill to provide a basis for expressing an opinion whether the fill material is compacted as specified. Density tests shall be performed in the compacted materials below any disturbed surface. When these tests indicate that the density of any layer of fill or portion thereof is below that specified, the particular layer or areas represented by the test shall be reworked until the specified density has been achieved.
- 8.3 During placement of *rock* fill, the Consultant should observe that the minimum number of passes have been obtained per the criteria discussed in Section 6.3.3. The Consultant should request the excavation of observation pits and may perform plate bearing tests on the placed *rock* fills. The observation pits will be excavated to provide a basis for expressing an opinion as to whether the *rock* fill is properly seated and sufficient moisture has been applied to the material. When observations indicate that a layer of *rock* fill or any portion thereof is below that specified, the affected layer or area shall be reworked until the *rock* fill has been adequately seated and sufficient moisture applied.
- 8.4 A settlement monitoring program designed by the Consultant may be conducted in areas of *rock* fill placement. The specific design of the monitoring program shall be as recommended in the Conclusions and Recommendations section of the project Geotechnical Report or in the final report of testing and observation services performed during grading.
- 8.5 We should observe the placement of subdrains, to check that the drainage devices have been placed and constructed in substantial conformance with project specifications.
- 8.6 Testing procedures shall conform to the following Standards as appropriate:

8.6.1 Soil and Soil-Rock Fills:

- 8.6.1.1 Field Density Test, ASTM D 1556, *Density of Soil In-Place By the Sand-Cone Method.*

- 8.6.1.2 Field Density Test, Nuclear Method, ASTM D 6938, *Density of Soil and Soil-Aggregate In-Place by Nuclear Methods (Shallow Depth)*.
- 8.6.1.3 Laboratory Compaction Test, ASTM D 1557, *Moisture-Density Relations of Soils and Soil-Aggregate Mixtures Using 10-Pound Hammer and 18-Inch Drop*.
- 8.6.1.4 Expansion Index Test, ASTM D 4829, *Expansion Index Test*.

9. PROTECTION OF WORK

- 9.1 During construction, the Contractor shall properly grade all excavated surfaces to provide positive drainage and prevent ponding of water. Drainage of surface water shall be controlled to avoid damage to adjoining properties or to finished work on the site. The Contractor shall take remedial measures to prevent erosion of freshly graded areas until such time as permanent drainage and erosion control features have been installed. Areas subjected to erosion or sedimentation shall be properly prepared in accordance with the Specifications prior to placing additional fill or structures.
- 9.2 After completion of grading as observed and tested by the Consultant, no further excavation or filling shall be conducted except in conjunction with the services of the Consultant.

10. CERTIFICATIONS AND FINAL REPORTS

- 10.1 Upon completion of the work, Contractor shall furnish Owner a certification by the Civil Engineer stating that the lots and/or building pads are graded to within 0.1 foot vertically of elevations shown on the grading plan and that all tops and toes of slopes are within 0.5 foot horizontally of the positions shown on the grading plans. After installation of a section of subdrain, the project Civil Engineer should survey its location and prepare an *as-built* plan of the subdrain location. The project Civil Engineer should verify the proper outlet for the subdrains and the Contractor should ensure that the drain system is free of obstructions.
- 10.2 The Owner is responsible for furnishing a final as-graded soil and geologic report satisfactory to the appropriate governing or accepting agencies. The as-graded report should be prepared and signed by a California licensed Civil Engineer experienced in geotechnical engineering and by a California Certified Engineering Geologist, indicating that the geotechnical aspects of the grading were performed in substantial conformance with the Specifications or approved changes to the Specifications.

LIST OF REFERENCES

1. California Division of Mines and Geology, *Landslide Hazards in The El Cajon Quadrangle, San Diego County, California*, Open File Report 92-11 (1992).
2. California Division of Mines and Geology, *Landslide Hazards in The San Vicente Reservoir Quadrangle, San Diego County, California*, Open File Report 92-04 (1992).
3. California Division of Mines and Geology, *Landslide Hazards in The Southern Part of The San Diego Metropolitan Area, San Diego County, California*, Open File Report 95-03 (1995).
4. California Division of Mines and Geology, *Landslide Hazards in The Northern Part of The San Diego Metropolitan Area, San Diego County, California*, Open File Report 95-04 (1995).
5. California Geological Survey, *Fault Activity Map of California*, compiled by Charles W. Jennings and William A. Bryant, 2010.
https://www.conservation.ca.gov/cgs/Pages/Program-RGMP/2010_faultmap.aspx
6. Geocon Incorporated, *Geotechnical Investigation, Fanita Ranch, Central Village (Area C)* (Project No. 05254-32-02), dated June 11, 1997.
7. Geocon Incorporated, *Geotechnical Investigation, Fanita Ranch, East Village (Area D)* (Project No. 05254-32-02), dated June 11, 1997.
8. Geocon Incorporated, *Soil and Geologic Reconnaissance, Fanita Ranch, Fanita Parkway Off-Site Improvements, Santee, California* (Project No. 05254-32-02), dated June 11, 1997.
9. Geocon Incorporated, *Geotechnical Investigation, Fanita Ranch, Off-site Improvement to Cuyamaca Street, Santee, California* (Project No. 05254-32-02), dated June 11, 1997.
10. Geocon Incorporated, *Update Geotechnical Investigation, Fanita Ranch, Sycamore Glen and Oak View, Santee, California* (Project No. 05254-32-11), dated April 25, 2005.
11. Geocon Incorporated, *Update Geotechnical Investigation, Fanita Ranch, Rock Point, Santee, California* (Project No. 05254-32-11), dated April 25, 2005.
12. Geocon Incorporated, *Update Geotechnical Investigation, Fanita Ranch, Sage Hill, Santee, California* (Project No. 05254-32-11), dated April 28, 2005.
13. Geocon Incorporated, *Supplemental Rippability Study, Rock Point/Sycamore Glen, Fanita Ranch, Santee, California* (Project No. 05254-32-12), dated September 29, 2005.
14. Geocon Incorporated, *Geotechnical Investigation, The Lake at Fanita, Santee, California* (Project No. 05254-32-13), dated March 29, 2007.
15. Geocon Incorporated, *Fanita Ranch, Fanita Parkway Widening and Extension, Station 9+35 to 111+50* (Project No. 05254-32-14), dated June 21, 2007.
16. Geocon Incorporated, *Supplemental Rippability Study for Oak View Street, Sycamore Glen, Fanita Ranch, Santee, California* (Project No. 05254-32-16), dated September 11, 2007.

LIST OF REFERENCES

17. Geocon Incorporated, *Transmittal of Preliminary Geotechnical Information, Rock Point, Fanita Ranch, Santee, California* (Project No. 05254-32-11A), dated August 28, 2014.
18. Law/Crandall, *Report of Geotechnical Consultation and Third Party Review, Oak Hills Landslide Repair and Geotechnical Evaluation, Santee Sports Park, Carlton Hills Boulevard, Santee, California*, dated August 30, 1991.
19. Leighton & Associates, *As-Graded Report of Rough Grading Operations of The Fill Areas at Council Heights Park, Santee, California*, dated December 12, 1984.
20. Leighton & Associates, *Revised Update Study for Geotechnical Land-Use Feasibility, Fanita Ranch - 2,500 Acres, Santee, California*, dated June 14, 1985, revised March 10, 1986.
21. Leighton & Associates, *Preliminary Geotechnical Studies, Fanita Ranch Phase 3, Santee, California*, dated January 19, 1987.
22. Leighton & Associates, *Preliminary Geotechnical Studies, Fanita Ranch Phase 4, Santee, California*, dated January 20, 1987.
23. Leighton & Associates, *Preliminary Geotechnical Studies, Fanita Ranch Phase 5, Santee, California*, dated January 21, 1987.
24. Leighton & Associates, *Geotechnical Studies, Fanita Ranch, Santee, California*, dated June 27, 1988.
25. Pacific Soils Engineering Inc., *Supplemental Geotechnical Evaluation and Grading Plan Review, Silver Country Estates, Units 2 and 3*, dated March 7, 1997.
26. Pacific Soils Engineering Inc., *Response to Third Party Review, Silver Country Estates, Units 2 and 7 (TM 92-02, 6-471)*, dated April 17, 1997.
27. Pacific Soils Engineering Inc., *Response to Third Party Review Comments (May 6, 1997), Silver Country Estates, Units 2 thru 7 (TM 93-02, G-471)*, dated May 13, 1997.
28. Southern California Soils and Testing Inc., *Revised Report of Geotechnical Investigation, Silver Country Estates, Cuyamaca Street and Cardoza Drive, Santee, California*, dated June 18, 1995.
29. U.S. Department of Agriculture, *1953 Stereoscopic Aerial Photographs, Flight AXN-9M, Photo Nos. 151, 152 and 153 (scale 1:20,000)*.
30. U.S. Geological Survey, *San Vicente Reservoir Quadrangle, 7.5 Minute Series (Topographic), 1955, photorevised 1971*.
31. U.S. Geological Survey, *El Cajon Quadrangle, 7.5 Minute Series (Topographic), 1967*.
32. U.S. Geological Survey, *La Mesa Quadrangle, 7.5 Minute Series (Topographic), 1994*.
33. U.S. Geological Survey, *Poway Quadrangle, 7.5 Minute Series (Topographic), 1967, photorevised 1975*.

LIST OF REFERENCES

34. U.S. Geological Survey, 2004, *Preliminary Geologic Map of the El Cajon 30'x60' Quadrangle, Southern California*, USGS Open File Report 2004-1361, Scale 1:100,000, compiled by Victoria R. Todd.
35. U.S. Geological Survey computer program, *Seismic Hazard Curves and Uniform Hazard Response Spectra*.
<https://earthquake.usgs.gov/designmaps/us/application.php>
36. *EZ-FRISK*, Site-specific Earthquake Hazard Analysis Software, Copyright 2016.
37. Boore, D. M., and G. M. Atkinson (2008), *Ground-Motion Prediction for the Average Horizontal Component of PGA, PGV, and 5%-Damped PSA at Spectral Periods Between 0.01 and 10.0 s*, Earthquake Spectra, Volume 24, Issue 1, pages 99-138, February 2008 (utilized by *EZ-FRISK* software).
38. Campbell, K. W., Y. Bozorgnia (2008), *NGA Ground Motion Model for the Geometric Mean Horizontal Component of PGA, PGV, PGD and 5% Damped Linear Elastic Response Spectra for Periods Ranging from 0.01 to 10 s*, Earthquake Spectra, Volume 24, Issue 1, pages 139-171, February 2008 (utilized by *EZ-FRISK* software).
39. Chiou, Brian S. J., and Robert R. Youngs (2008), *A NGA Model for the Average Horizontal Component of Peak Ground Motion and Response Spectra*, preprint for article to be published in NGA Special Edition for Earthquake Spectra (utilized by *EZ-FRISK* software).